



RECYCLED PAPER

2020

# GENERAL CATALOGUE

## 50Hz



WATER • TECHNOLOGY



THE FUTURE **WAITS FOR NO ONE**



**DAB**<sup>®</sup>  
WATER • TECHNOLOGY



WATER BOOSTING



CONDITIONING



GARDENING & IRRIGATION



HEATING

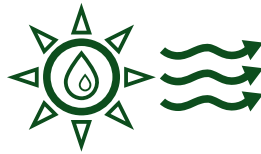

SOLAR PANELS



HOT WATER



DRAINAGE



EFFLUENT



SEWAGE

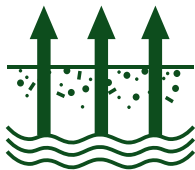

GROUND WATER



MACERATORS



SWIMMING POOL



RAIN WATER REUSE



FIRE FIGHTING



IRRIGATION SYSTEMS

# NEW IN THE 2020 GENERAL CATALOGUE



## DCONNECT BOX 2

REMOTE CONTROL FOR ELECTRONIC RESIDENTIAL AND COMMERCIAL SYSTEMS

NEW

PAG. 5



## ESWIM/EPRO

ELECTRONIC SWIMMING POOL PUMP

NEW MODELS

PAG. 116



## NOVA

SUBMERSIBLE PUMPS FOR DRAINAGE

NEW

PAG. 212



## FEKA

SUBMERSIBLE PUMPS FOR EFFLUENT

NEW

PAG. 215



## DRENAG FX

SUBMERSIBLE PUMPS FOR DRAINAGE OF SANDY WATER AND WATER FROM CONSTRUCTION SITE

NEW

PAG. 218



## GRINDER FX

SUBMERSIBLE PUMPS WITH CUTTING SYSTEM FOR SEWAGE

NEW

PAG. 219



## FEKA FXV

SUBMERSIBLE PUMPS FOR SEWAGE

NEW

PAG. 220



## FEKA FXC

SUBMERSIBLE PUMPS FOR EFFLUENT

NEW

PAG. 222



## FEKABOX 200 FX

AUTOMATIC PUMPING STATION

NEW MODEL

PAG. 232

# NEW IN THE 2020 GENERAL CATALOGUE



## DIVER 6

SUBMERSIBLE MULTI-IMPELLER PUMPS

NEW

PAG. 273



## DTRON 2

7" ELECTRONIC MULTISTAGE SUBMERSIBLE PUMPS

NEW

PAG. 276



## DTRON 3

7" ELECTRONIC MULTISTAGE SUBMERSIBLE PUMPS

NEW

PAG. 277



## ESYBOX DIVER

7" MULTISTAGE SUBMERSIBLE PUMPS WITH VARIABLE FREQUENCY DRIVE

NEW

PAG. 278



## 2/3 KVCXE DCONNECT

VARIABLE SPEED PRESSURISATION UNITS WITH MCE AND DCONNECT

NEW

PAG. 334



## 2/3 NKVE 10/15/20/32/45 DCONNECT

VARIABLE SPEED PRESSURISATION UNITS WITH MCE AND DCONNECT

NEW

PAG. 339

## YOUR SYSTEMS ARE JUST A CLICK AWAY

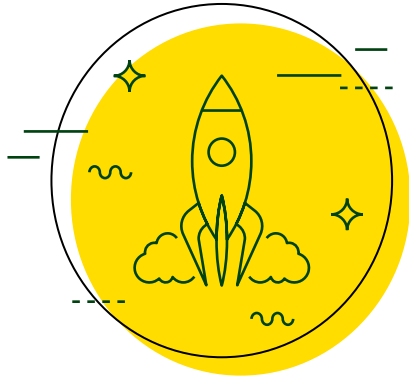

### IMMEDIATELY READY TO USE

DConnect does not require specific infrastructures. The installation only requires an internet connection and a smartphone. Just follow the few steps of the connection wizard to connect your pumps.

### TECHNOLOGY FOR EVERYONE

Based on state-of-the-art technology, the DConnect system offers many advantages than typical BMS systems.

### THE SERVICE THAT MAKES LIFE EASIER

DConnect makes monitoring DAB products easy and intuitive. All adjustments are also possible remotely. For total control with no surprises.

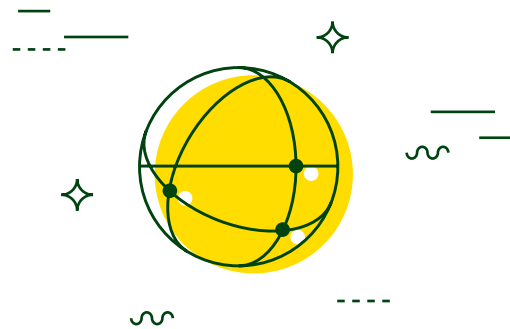

### WE ARE VERY CAREFUL ABOUT YOUR SAFETY

Dab takes data safety very seriously. This is why DConnect products are continuously updated and improved, to make sure that they always comply with the latest standards, in order to counteract any effects of the new dangers that are discovered every day.

## UNRIVALLED ADVANTAGES

### DConnect

#### TAILOR DESIGN

Developed for both residential and commercial building service application.

#### SOFTWARE & HARDWARE

You do not need to buy any expensive software, nor do you need to pay for updates or for dedicated work stations.

#### USE

No fixed work station is required as the DConnect is all about portability, the only thing you need is a internet connection.

#### VALUE

It lowers the overhead costs, increasing the value of your building.

# D+CONNECT BOX



DConnect Box 2 expands the range of DConnect products. This latest addition is the ideal solution for small systems (connection of up to 4 products). It joins big brother DConnect Box, which can manage larger systems (connection of up to 8 products), and is compatible with a wide range of DAB products. Both can also be used on already installed products. All that is required is constant internet access at the place of installation.

## APP & CLOUD

Using the DConnect App, available on App Store and Google Play, it is possible to check the settings of compatible products.

Taking advantage of the Cloud service, through the website [internetofpumps.com](http://internetofpumps.com) or the **DConnect App**, it is also possible to remotely check the installation and receive alarms in real time, wherever you are, through an extremely clear and functional user interface.

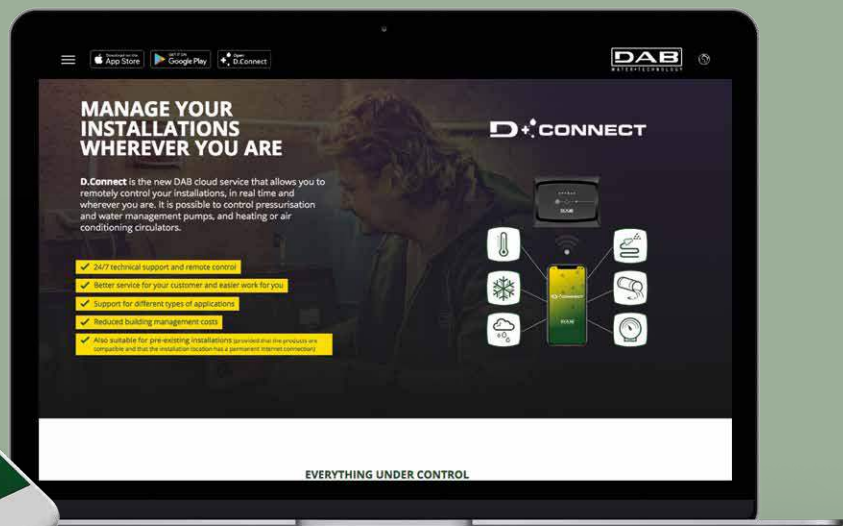

[INTERNETOFPUMPS.COM](http://INTERNETOFPUMPS.COM)



## A SINGLE INTERFACE FOR EVERY APPLICATION

DConnect is suitable for pressurization systems, circulation systems and for installations for the recovery of waste water.

IT represents a high added value service that can be used with any system, irrespective of its nature and size and in the same environment and with the same instruments, from the individual villa to large structures.

Being modular, DConnect can manage up to 8 different electronic pumps in a highly simple and integrated manner.

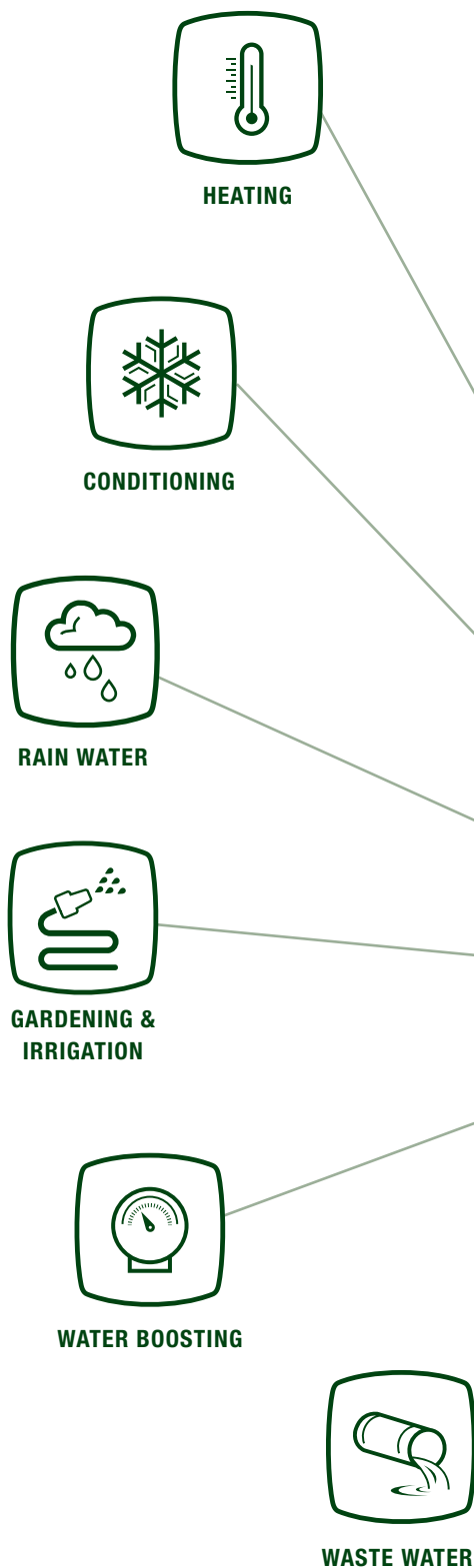

### SMART BUILDING MANAGEMENT

DConnect permits easier, controlled and more rational management of the system, lowering the overhead costs and increasing the absolute value of the building in terms of efficiency and overall comfort.



**WITH EACH QUESTION,  
AN ANSWER!  
SCAN THE QR CODE AND  
CONSULT OUR FAQ SECTION**

# OPERATION DIAGRAM

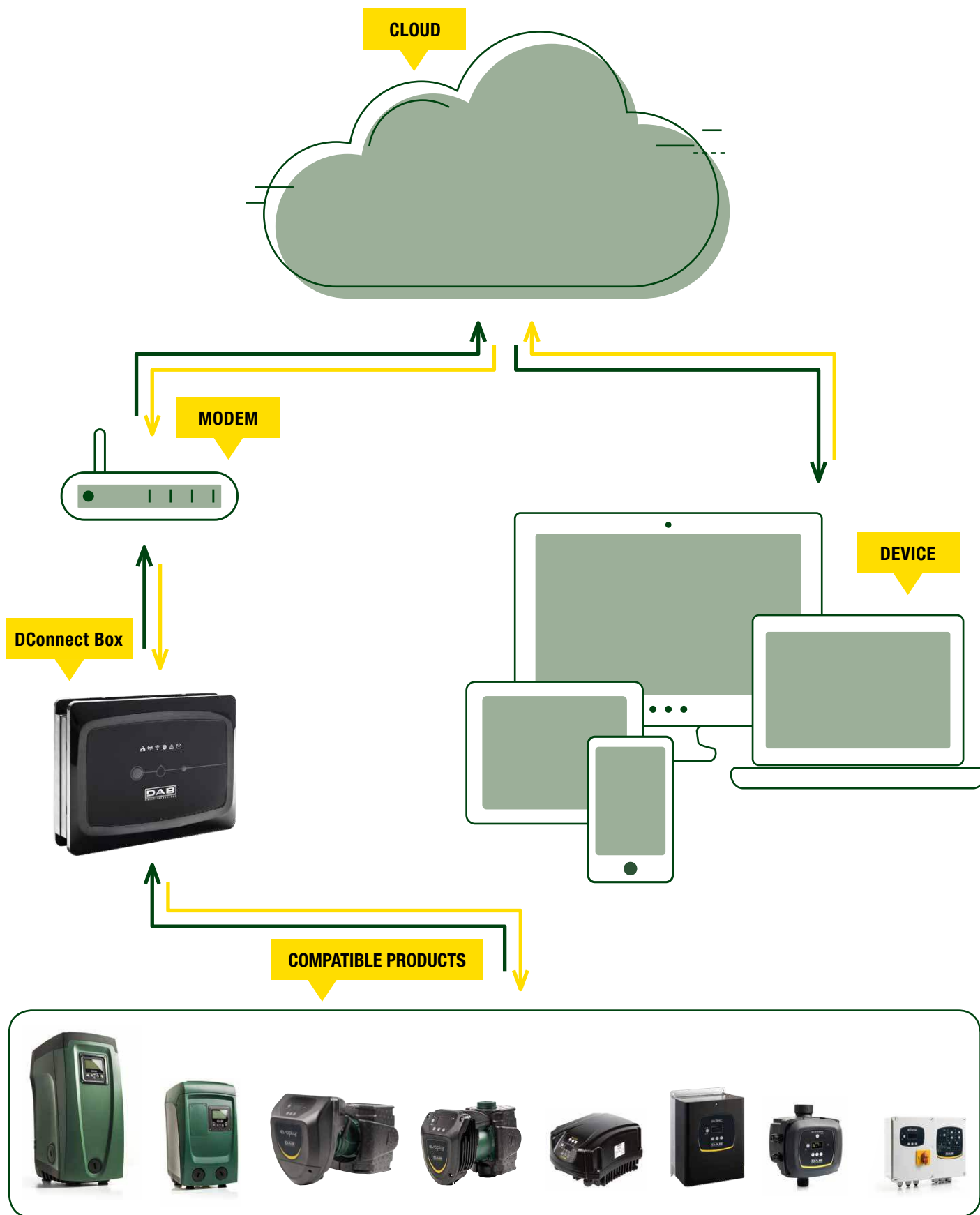

For more information visit: [internetofpumps.com](http://internetofpumps.com)

# COMPATIBLE PRODUCTS CONNECTIONS



# DCONNECT BOX

REMOTE CONTROL FOR ELECTRONIC RESIDENTIAL AND COMMERCIAL SYSTEMS



1x

+



1x

Max 4x

MODEL	CODE
DCONNECT BOX	60172819

MODEL	CODES AVAILABLE AT PAGE 103
ESYBOX	

Update to the following version is required:  
VE 5.X or later



1x

+



1x

Max 4x  
(no group)

MODEL	CODE
DCONNECT BOX	60172819

MODEL	CODES AVAILABLE AT PAGE 102
ESYBOX MINI <sup>3</sup>	

Update to the following version is required:  
VE 2.X or later



1x

+



1x

+



1x

Max 8x

MODEL	CODE
DCONNECT BOX	60172819

MODEL	CODE
MODBUS CABLE 15 m	60188145
MODBUS CABLE 100 m	60188144

MODEL	CODES AVAILABLE AT PAGE 44
EVOPLUS	

# DCONNECT BOX

REMOTE CONTROL FOR ELECTRONIC RESIDENTIAL AND COMMERCIAL SYSTEMS



1x

+



1x

+



1x

+



1x

**Max 8x**

MODEL	CODE	MODEL	CODE
DCONNECT BOX	60172819	MODBUS CABLE 15 m	60188145
		MODBUS CABLE 100 m	60188144
		MULTIFUNCTION MODULE*	60152884

\* Not required for Evoplus Small in twin installation

MODEL	CODE
EVOPPLUS SMALL (SINGLE)	Codes available at page 42



1x

+



1x each inverter/group

+



1x

**Max 8x**

MODEL	CODE
DCONNECT BOX	60172819

MODEL	CODE
CABLE FOR MCE CONNECTION 2 m + CLAMP	60188147

MODEL	CODE
MCE/P	Codes available at page 23

Only the MCE/P with DConnect READY label are DConnect compatible



1x

+



1x each inverter/group

+



1x

**Max 2x**

MODEL	CODE
DCONNECT BOX	60172819

MODEL	CODE
CABLE FOR MCE CONNECTION 2 m + CLAMP	60188147

MODEL	CODE
MCE/C	Codes available at page 22

Only the MCE/C with DConnect READY label are DConnect compatible

# DCONNECT BOX

REMOTE CONTROL FOR ELECTRONIC RESIDENTIAL AND COMMERCIAL SYSTEMS



1x

+



1x each inverter/group

+



1x

Max 8x

MODEL	CODE
DCONNECT BOX	60172819

MODEL	CODE
CABLE FOR ADAC CONNECTION 2 m	60188150

MODEL	Codes available at page 24
ADAC	

Only the ADAC with DConnect READY label are DConnect compatible



1x

+



1x each inverter/group

+



1x

Max 8x

MODEL	CODE
DCONNECT BOX	60172819

MODEL	CODE
CABLE FOR AD PLUS CONNECTION 5 m + CLAMP	60188148
SPECIAL CABLE FOR A SECOND GROUP 5 m + CLAMP	60189926

MODEL	Codes available at page 25
ACTIVE DRIVER PLUS	

Update to the following version is required: VE 2.X or later



1x

+



1x

+



1x

Max 4x





MODEL	CODE
DCONNECT BOX	60172819

MODEL	CODE
KIT USB CABLE 2 m + CLAMP	60188149

MODEL	Codes available at page 27
EBOX	

Only the EBOX with DConnect READY label are DConnect compatible

# DCONNECT BOX ACCESSORIES

MODEL		CODE
	ETHERNET CABLE 2m (to use in case of LAN connection)	60188146
	KIT MODEM WiFi (ONLY FOR EU MARKETS)	60195804
	KIT MODEM WiFi + WALL CHARGER (ONLY FOR EU MARKETS)	60197540
	DCONNECT BOX BMS ADAPTER KIT (MODBUS RTU RS485)	60198693
	KIT CHARGER MINI UPS FOR DCONNECT BOX	60198905
	DCONNECT BOX PANEL - IP 65 (DConnect Box included)	60198153

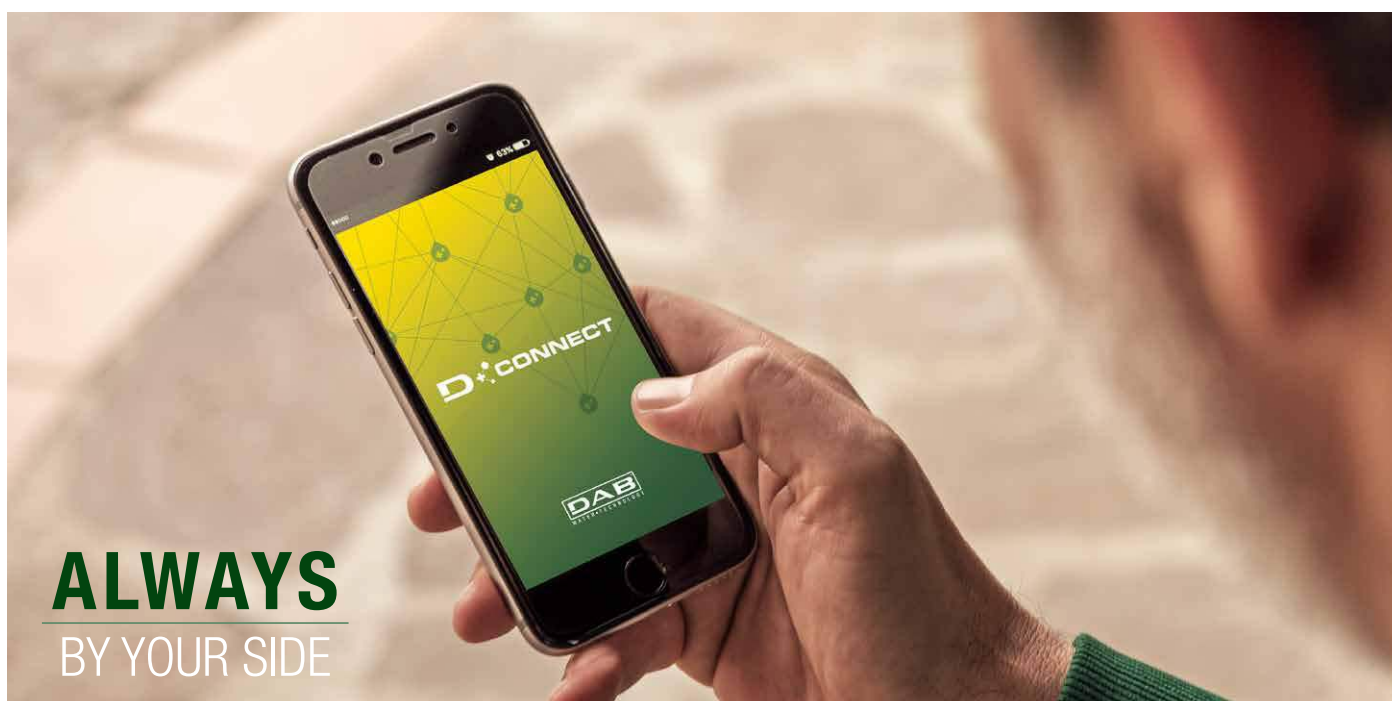

**ALWAYS**  
BY YOUR SIDE

# OPERATION DIAGRAM

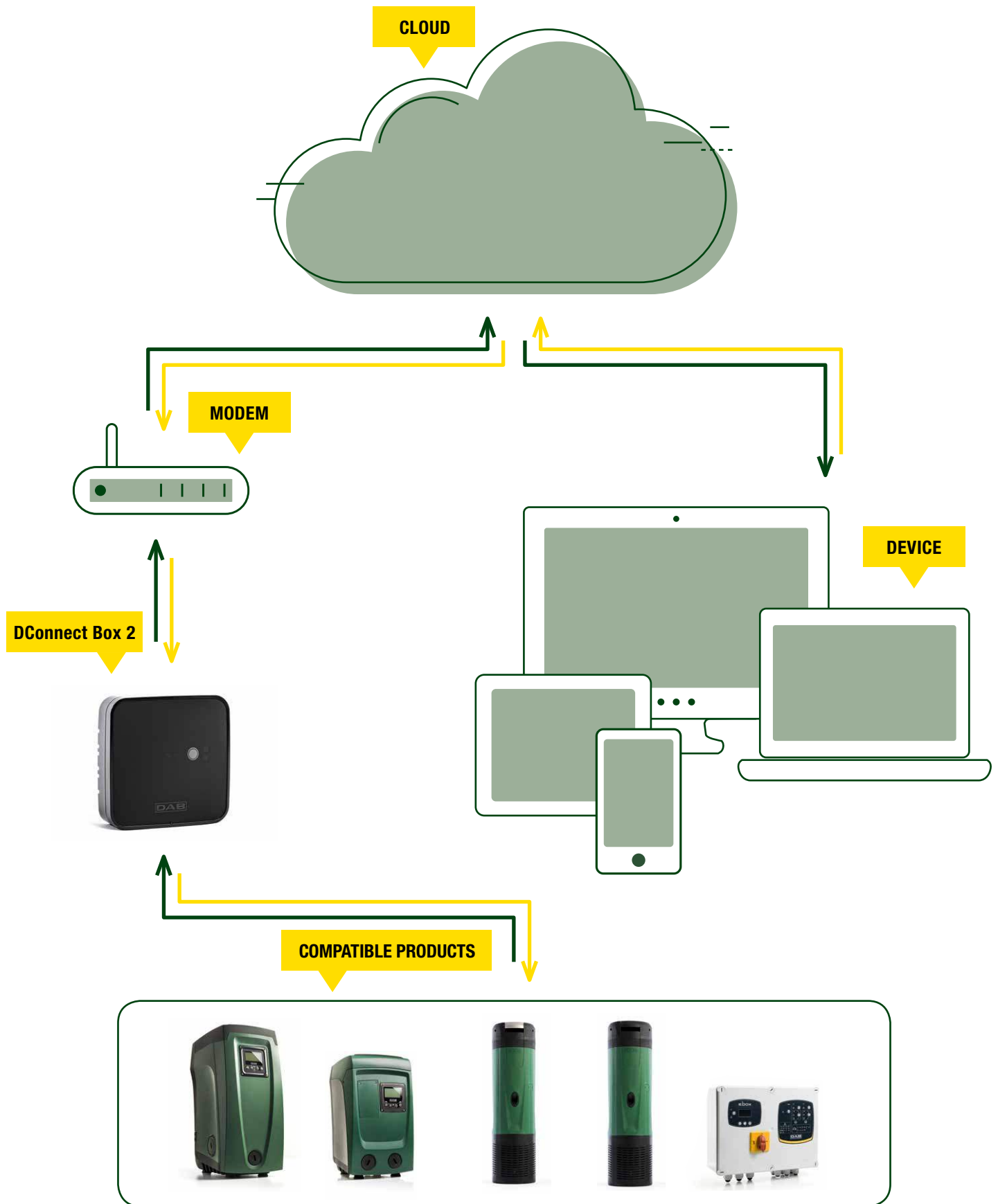

For more information visit: [internetofpumps.com](http://internetofpumps.com)



# COMPATIBLE PRODUCTS CONNECTIONS



INPUT

MODBUS



OUTPUT

# DCONNECT BOX 2

REMOTE CONTROL FOR ELECTRONIC RESIDENTIAL AND COMMERCIAL SYSTEMS



1x

+



1x

Max 4x

MODEL	CODE
DCONNECT BOX 2	60196424

MODEL	CODES AVAILABLE AT PAGE 103
ESYBOX	

Update to the following version is required:  
VE 5.X or later



1x

+



1x

Max 4x  
(no group)

MODEL	CODE
DCONNECT BOX 2	60196424

MODEL	CODES AVAILABLE AT PAGE 102
ESYBOX MINI <sup>3</sup>	

Update to the following version is required:  
VE 2.X or later



1x

+



1x

Max 1x

MODEL	CODE
DCONNECT BOX 2	60196424 (Included with Esybox Diver)

MODEL	CODES AVAILABLE AT PAGE 278
ESYBOX DIVER	

# DCONNECT BOX 2

REMOTE CONTROL FOR ELECTRONIC RESIDENTIAL AND COMMERCIAL SYSTEMS



1x

+



1x

Max 1x

MODEL	CODE
DCONNECT BOX 2	60196424

MODEL	CODE
DTRON 3	Codes available at page 277

Update to the following version is required:  
VE 5.X or later



1x

+



1x

+



1x

Max 1x

MODEL	CODE
DCONNECT BOX 2	60196424

MODEL	CODE
KIT USB CABLE 2 m + CLAMP	60188149

MODEL	CODE
EBOX	Codes available at page 27

Only the EBOX with DConnect READY label are DConnect compatible

## DCONNECT BOX 2 ACCESSORIES

MODEL	CODE	
	KIT MODEM WIFI (ONLY FOR EU MARKETS)	60195804
	KIT MODEM WIFI + WALL CHARGER (ONLY FOR EU MARKETS)	60197540



**COMMAND AND  
CONTROL SYSTEMS**

**PAG.21**

**CIRCULATORS  
AND IN-LINE PUMPS**

**PAG.35**

**MULTISTAGE SELF-PRIMING  
AND CENTRIFUGAL PUMPS**

**PAG.89**

**SWIMMING POOL, POND  
AND SALT WATER PUMPS**

**PAG.115**

**CENTRIFUGAL PUMPS**

**PAG.131**

**SUBMERSIBLE PUMPS**

**PAG.211**

**SUBMERSIBLE PUMPS  
AND SUBMERSIBLE MOTORS**

**PAG.267**

**PRESSURE UNITS**

**PAG.329**



**D+CONNECT**

**AFFORDABLE WEB  
BASED REMOTE  
CONTROL FOR  
EVERYONE**

[INTERNETOFPUMPS.COM](http://INTERNETOFPUMPS.COM)

**DAB**  
WATER • TECHNOLOGY

# INDEX - COMMAND AND CONTROL SYSTEMS

## INVERTER



### MCE/C

INVERTER FOR CIRCULATING PUMPS

ED

PAG. 22



### MCE/P

INVERTER FOR PRESSURE PUMPS

ED

PAG. 23



### ADAC

INVERTER FOR PRESSURE PUMPS

EA

PAG. 24



### ACTIVE DRIVER PLUS

INVERTER

AS

PAG. 25



### SUNDRIVER

ELECTRONIC PROTECTION AND CONTROL PANELS WITH INVERTER FOR SOLAR PANEL SYSTEMS

AT

PAG. 26

## ON/OFF DEVICES



### EBOX

CONTROL PANEL

AT

PAG. 27



### SMART PRESS

ON/OFF CONTROLLER

AR

PAG. 28



### ACCESSORIES

PAG. 29

# MCE/C

## INVERTER



**MCE/C** inverters are used for the management of circulation pumps and set themselves apart due to ease of use, power, simplicity of installation and management.

**MCE/C** inverters are designed for use with circulator pumps to enable simple control of differential pressure, thereby adapting pump performance to match effective system requirements.

The solution of mounting on the motor base greatly simplifies installation of the pump with **MCE/C** in minimal times.

Ease of programming is guaranteed by the use of an interface similar to DAB Dialogue and a graphic display.

**MCE/C** inverters feature dual microprocessor architecture to guarantee maximum efficiency and reliability. Sturdy and reliable construction is combined with modern and innovative styling to complete the product also in terms of aesthetics.

**MCE/C** inverters protect the pump thanks to integrated safety devices. They are also able to prolong the useful lifetime of the pump thanks to the elimination of water hammer and rotation of the pump at the minimum rpm necessary to meet the requirements of the user.

Last but not least, these inverters save power by keeping pump consumption to the minimum levels strictly necessary to meet user requirements.

**Equipped with communication module for the creation of twin pumpsets.**

**Should P-v proportional differential pressure regulation be required, specify the pump model on which the inverter will be installed.**

**When installing twin sets, the connection cable must be ordered separately.**



PAG. 5

ACCESSORIES  
PAG. 29

MODEL	CODE	NOMINAL MOTOR POWER KW	MAX NOMINAL MOTOR CURRENT A	MIN NOMINAL MOTOR CURRENT A	VOLTAGE 50 Hz	PUMP VOLTAGE 50 Hz	MOTOR FRAME
MCE/C 11	60144656	1.1	6.5	1.0	Single-phase 1x230	Three-phase 3x230	71 80
MCE/C 15	60144657	1.5	8,0	1.0	Single-phase 1x230	Three-phase 3x230	90
MCE/C 22	60144659	2.2	10.5	1.0	Single-phase 1x230	Three-phase 3x230	90 100
MCE/C 30	60144660	3	7,5	2.0	Three-phase 3x400	Three-phase 3x400	100
MCE/C 55	60144662	5,5	13,5	2.0	Three-phase 3x400	Three-phase 3x400	112 132
MCE/C 110	60144664	11.0	24	2.0	Three-phase 3x400	Three-phase 3x400	132 160
MCE/C 150	60144665	15.0	32	2.0	Three-phase 3x400	Three-phase 3x400	160



# MCE/P

## INVERTER



**MCE/P** inverters are used for the management of pressurization pumps intended for complex professional applications. MCE/P inverters can drive three-phase pumps up to 15kW. These units combine the simplicity with the robust design and power of an inverter drive.

**MCE/P** are mounted on the pump, and are equipped with pressure sensors and the **optional flow sensors** as required. The use of a flow sensor, moreover, allows a better pressure regulation.

The **MCE/P** can easily be set up in booster sets, thanks to a standard wire cable connection.

Comfort, energy saving, protections and simplicity are the keywords of this professional series.

The **MCE/P** units are air cooled.

The **MCE/P** can be easily installed in existing systems and can operate with all pumps Facility to create sets with interchange of up to 8 pumps

PAG. 5

ACCESSORIES  
PAG. 29

MODEL	CODE	NOMINAL MOTOR POWER KW	MAX NOMINAL MOTOR CURRENT A	MIN NOMINAL MOTOR CURRENT A	VOLTAGE 50 Hz	PUMP VOLTAGE 50 Hz	MOTOR FRAME
MCE/P 11	60145919	1.1	6.5	1.0	Single-phase 1x230	Three-phase 3x230	71 80
MCE/P 15	60145920	1,5	8,0	1.0	Single-phase 1x230	Three-phase 3x230	90
MCE/P 22	60145921	2.2	10.5	1.0	Single-phase 1x230	Three-phase 3x230	90 100
MCE/P 30	60145922	3	7,5	2.0	Three-phase 3x400	Three-phase 3x400	100
MCE/P 55	60145923	5,5	13,5	2.0	Three-phase 3x400	Three-phase 3x400	112 132
MCE/P 110	60145924	11.0	24	2.0	Three-phase 3x400	Three-phase 3x400	132 160
MCE/P 150	60145925	15.0	32	2.0	Three-phase 3x400	Three-phase 3x400	160

# ADAC

## INVERTER



### ADAC inverters are intended for **HEAVY PROFESSIONAL APPLICATIONS.**

They can drive pumps of up to 15 kW. These units combine the simplicity with the robust design and power of an inverter drive. They can be installed in a control panel and must be supplied with external pressure.

The use of a flow sensor (OPTIONAL), allows a better pressure regulation.

The **ADAC** can easily be set up in booster sets, thanks to a standard wire cable connection.

Comfort, energy saving, protections and simplicity are the keywords of this professional series.

The ADAC units are air cooled. These extremely robust panel-mounting inverters feature a metal body and are suitable for heavy-duty applications. ADAC ensure the utmost practicality and increase the average workinglife of the system, permitting also significant savings in power consumption.

# ADAC

**D+CONNECT** PAG. 5

ACCESSORIES  
PAG. 29

MODEL	CODE	NOMINAL MOTOR POWER kW	MAX NOMINAL MOTOR CURRENT A	MIN NOMINAL MOTOR CURRENT A	VOLTAGE 50 Hz	PUMP VOLTAGE 50 - 200 Hz
ADAC M/T 1.0	60145522	1,0	6,5	1	Single-phase 1x230	3x230
ADAC M/T 1.5	60145523	1,5	9,0	1	Single-phase 1x230	3x230
ADAC M/T 2.2	60145524	2,2	11,5	1	Single-phase 1x230	3x230
ADAC T/T 3.0	60145525	3,0	9,0	2	Three-phase 3x400	3x400
ADAC T/T 4.0	60145526	4,0	11	2	Three-phase 3x400	3x400
ADAC T/T 5.5	60145527	5,5	15	2	Three-phase 3x400	3x400
ADAC T/T 7.5	88002773	7,5	22	2	Three-phase 3x400	3x400
ADAC T/T 11	88002774	11	31	2	Three-phase 3x400	3x400
ADAC T/T 15	88002775	15	41	2	Three-phase 3x400	3x400

# ACTIVE DRIVER PLUS

INVERTER



## ACTIVEDRIVER plus

Active Driver Plus are inverters used for the control of hydraulic pumps. Their obvious fields of application are domestic, industrial, and agricultural constant pressure pumping systems.

The OLED display offers an extremely simple and intuitive graphic interface. Displaying or changing any parameters is extremely simple, which in turn also simplifies maintenance.

Installation is also very easy: the installation wizard asks the user for the parameters required for the configuration.

Active Driver Plus inverters provide a reduction of electric consumption, thanks to the inverter technology, whilst at the same time ensuring maximum comfort thanks to the constant pressure.

They are extremely versatile, as they do not require external sensors and non-return valves. There is in-fact a built-in pressure sensor, a flow switch, and a non-return valve.

The advantages of Active Driver Plus are:

- comfort, thanks to the constant pressure,
- energy savings, thanks to the inverter technology.
- less noise,
- compact shape,
- all the built-in protections: dry run, overload, abnormal voltage, overtemperature, freezing.

**Line voltage** 115V and 230V single-phase. 400V three-phase

**Electric pump voltage** 115V and 230V single-phase, 230V and 400V three-phase

**Power supply frequency** 50 Hz - 60 Hz.

**Installation** vertical and horizontal (M/M and M/T only)

**Maximum liquid temperature** 50°C.

**Max operating temperature** 50°C.

**Max flow rate** 18m<sup>3</sup>/h.

**Maximum working pressure** 13 bar.

**Pressure regulation range** from 1 to 13 bar.

**Suction diameter (DNA)** 1 1/4" male.

**Delivery diameter (DNM)** 1 1/2" female.

**Protection level** IP55.

**Communication interface for sets**

YES, an Active Driver Plus for each pump

**Non-return valve not required**

**Equipped with graphic display**



**D+CONNECT** PAG. 5

MODEL	CODE	MAX CURRENT OF MOTOR A	MAX MOTOR POWER kW	VOLTAGE 50 Hz	PUMP SUPPLY VOLTAGE Volt	CONNECTIVITY FOR PARALLEL WORKING	TO BE USED WITH PUMPS TYPE	PRESSURE REGULATION RANGE BAR	WEIGHT Kg	Q.TY X PALLET
ACTIVE DRIVER PLUS M/M 1,1	60149661	8,5	1,1	Single-phase 1x230	Single-phase 1x230	YES	Surface pumps, 4" submersible pumps and 5" pumps with single-phase motor and input current of up to 8,5 A	1-9	3,5	32
ACTIVE DRIVER PLUS M/M 1,5/DUAL VOLTAGE	60170688	11	0,55	Single-phase 1x115	Single-phase 1x115	YES	Surface pumps, 4" submersible pumps and 5" pumps with single-phase motor and input current of up to 11 A	1-9	3,5	32
				1,5	1x230					
ACTIVE DRIVER PLUS M/M 1,8/DUAL VOLTAGE	60170689	14	1,0	Single-phase 1x115	Single-phase 1x115	YES	Surface pumps, 4" submersible pumps and 5" pumps with single-phase motor and input current of up to 14 A	1-9	3,8	32
				1,8	1x230					
ACTIVE DRIVER PLUS M/T 1	60169777	4,7	1,0	Single-phase 1x230	Three-phase 3x230	YES	Surface pumps, 4" submersible pumps and 5" pumps with three-phase 230V motor and input current of up to 4,7 A	1-9	3,5	32
ACTIVE DRIVER PLUS M/T 2,2	60170687	10,5	2,2	Single-phase 1x230	Three-phase 3x230	YES	Surface pumps, 4" submersible pumps and 5" pumps with three-phase 230V motor and input current of up to 10,5 A	1-13	3,5	32
ACTIVE DRIVER PLUS T/T 3	60169808	7,5	3,0	Three-phase 3x400	Three-phase 3x400	YES	Surface pumps, 4" submersible pumps and 5" pumps with three-phase 400V motor and input current of up to 7,5 A	1-13	4,5	32
ACTIVE DRIVER PLUS T/T 5,5	60170715	13,3	5,5	Three-phase 3x400	Three-phase 3x400	YES	Surface pumps, 4" submersible pumps and 5" pumps with three-phase 400V motor and input current of up to 13,3 A	1-13	4,6	32

# SUNDRIVER

ELECTRONIC PROTECTION AND CONTROL PANELS WITH INVERTER FOR SOLAR PANEL SYSTEMS



Protection and control inverter control panel for "off-grid" (not connected to the electricity network) photovoltaic systems, for use with different types of pumping systems, from collection from the subsoil, to swimming pool circulation and filtering, to the transfer and accumulation of water from tanks and vessels.

Designed to be mainly powered by solar energy; however, in case of need powering from the electricity network or from a generator is also possible - using a manual selector switch, therefore also ensuring operation when solar energy is not available.

It's equipped with overcurrent, overvoltage, overtemperature, motor short circuit and dry run protection systems.

Level probes, a float and a flow switch may be connected to the control panel. The control panel is air-cooled by active fans.

When used in conjunction with pumps, it allows energy savings when compared with pumps without inverters, and also provides protection from hammering effects.

Two electric probes are supplied as standard.

## Nominal power input voltage

VDC 420 V.

VAC 300 V.

**Frequency** 50 Hz - 60 Hz.

## Maximum power of use

0,37-3 kWatt.

0,5-4 Hp.

## Pump operating range

230 V pump power input:

pump on = above 290 Vdc / 206 Vac

pump off = below 190 Vdc / 135 Vac

115 V pump power input:

pump on = above 140 Vdc / 100 Vac

pump off = below 110 Vdc / 180 Vac

## Ambient temperature operation limits

+50°C.

**Protection class** IP 54

# SUNDRIVER

ACCESSORIES  
PAG. 29

MODEL	CODE	ELECTRICAL DATA					
		NETWORK VOLTAGE 50 HZ	PUMP VOLTAGE 50 HZ	SETUP	P2 NOMINAL		In A
					kW	HP	
SUNDRIVER 1/50	60188600	115-230 V M	115 T	SETUP 1	0,37	0,5	4,7
				SETUP 2	0,55	0,75	7,5
				SETUP 3	0,75	1	9,1
SUNDRIVER 2/50	60188601	230 V M	230 T	SETUP 1	0,37	0,5	2,8
				SETUP 2	0,55	0,75	3,8
				SETUP 3	0,75	1	4,5
SUNDRIVER 3/50	60188602	230 V MT	230 T	SETUP 1	1,1	1,5	6,2
				SETUP 2	1,5	2	7,9
SUNDRIVER 4/50	60188603	230 V T	230 T	SETUP 1	2,2	3	10,4
				SETUP 2	3	4	13,6

# EBOX

## ELECTRONIC PROTECTION AND CONTROL PANEL



EBOX plus D



EBOX basic

**EBOX plus** is an electronic control panel for the protection and automatic operation of one or two submersible pumps or pressurizing both single-phase and three-phase, installed in domestic, civil and industrial environments.

**EBOX basic** is an electronic control panel for the protection and automatic operation of one or two electronic submersible pumps or single-phase pressurization for domestic applications.

### Nominal tension of power supply

**EBOX plus** 1x 230 V / 3 x 230 V - 3 x 400 V (automatic selection)

**EBOX basic** 1x 230 V

**Frequency** 50 - 60 Hz

### Maximum use of power

**EBOX plus** 5,5 kWatt + 5,5 kWatt

**EBOX basic** 2,2 kWatt + 2,2 kWatt

**Maximum use of current** 12 A + 12 A

### Starting capacitor

KIT supplied as an accessory

### Limits of use ambient temperature

-10° C + 40° C

### Limits of storage temperature

-25° C + 55° C

**Relative humidity to the air** 90% a 20° C

**Max altitude max** 1000 s.l.m.

**Degree of protection** IP 55

Reference standard for the construction of the panels EN 60335-1

# ebox

D CONNECT

PAG. 5

ACCESSORIES  
PAG. 29

MODEL	CODE	VOLTAGE 50 HZ	STARTING	P2 NOMINAL		MAX CURRENT A	DISPLAY
				KW x2	HP x2		
<b>EBOX BASIC 230/50-60</b>	60163214	1 X 230 V	DIRECT	2,2	3	12+12	-
<b>EBOX PLUS 230-400V/50-60</b>	60163215	1 X 230 V	DIRECT	2,2	3	12+12	-
		3 X 230 V		3	4		
		3 X 400 V		5,5	7,5		
<b>EBOX BASIC D 230/50-60</b>	60163216	1 X 230 V	DIRECT	2,2	3	12+12	•
<b>EBOX PLUS D 230-400V/50-60</b>	60163217	1 X 230 V	DIRECT	2,2	3	12+12	•
		3 X 230 V		3	4		
		3 X 400 V		5,5	7,5		

## DISPLAY



Thanks to the configuration wizard, installation of display versions is much simpler. Management is also much easier, thanks to the status always being visible and to a range of additional functions, such as the anti-seizing of drainage pumps, the alarm log, the language selection, and the password protected settings.

# SMART PRESS

ON/OFF CONTROLLER



SMART PRESS is an ON/OFF electronic device designed to switch the pump ON/OFF without using an expansion vessel. The device protects the pump against dry running without using level probes or float switch.

It has an adjustable cut-in pressure and even with a high flow the pressure losses are small. All the SMART PRESS models have a MANUAL AND AUTOMATIC RESTART.

## SMART PRESS

MODEL	CODE	SETTING PRESSURE bar	DNA GAS	DNM GAS	WEIGHT Kg	Q.TY x PALLET
SMART PRESS WG 1,5 - AUTOM. RESET - WITHOUT CABLE	60114808	1,5	1" M	1" 1/4 F	1,3	100
SMART PRESS WG 1,5 - AUTOM. RESET - WITH CABLE	60113308	1,5	1" M	1" 1/4 F	1,6	100
SMART PRESS WG 3.0 - AUTOM. RESET - WITHOUT CABLE	60114809	1,5	1" M	1" 1/4 F	1,3	100
SMART PRESS WG 3.0 - AUTOM. RESET. - WITH CABLE	60113922	1,5	1" M	1" 1/4 F	1,6	100

# ACCESSORIES FOR COMMAND AND CONTROL SYSTEM

---

# INVERTER ACCESSORIES



## NOTES FOR PER MCE/C INSTALLATION

SINGLE INSTALLATION (Accessories to order)	MULTIPLE INSTALLATION (Accessories to order)
- differential sensor	- differential sensor - connection cable

## NOTES FOR ADAC AND MCE/P INSTALLATION

SINGLE INSTALLATION (Accessories to order)	MULTIPLE INSTALLATION FROM 2 UP TO 8 INVERTER (Accessories to order)
- pressure sensor OPTIONAL: flow sensor, flow sensor bracket, flow sensor cable.	- pressure sensor - connection cable (number as necessary to connect all inverters installed; e.g. for 8 inverters order 7 connection cables).

**IMPORTANT:** optionally more than one pressure sensor can be fitted (min. 1 per inverter, max. 1 per inverter). Optional: flow sensor, flow sensor bracket, flow sensor cable.  
**IMPORTANT:** just 1 flow sensor can be fitted on the outlet manifold or 1 flow sensor on the outlet of each pump.







PRESSURE SENSOR	DESCRIPTION	MCE/C	ADAC	MCE/P	EBOX	CODE
	DIFFER. SENSOR 4BAR HUBA (C)	•				60144674
	DIFFER. SENSOR 10BAR HUBA (C)	•				60144675
	PRESS. SENSOR 25 BAR COMPL. WITH CABLE (2 MT.)		•	•		60146289
	PRESS. SENSOR 25 BAR COMPL. WITH CABLE (4 MT.)		•	•		88002533
	PRESS. SENSOR. 4-20 MA - 25 BAR WITH CABLE (1,5 MT)		•	•		60162878

FLOW SWITCH	DESCRIPTION	MCE/C	ADAC	MCE/P	EBOX	SUNDRIVER	CODE
	1" FLOW SWITCH					•	60114408





# INVERTER ACCESSORIES

FLOW SENSOR	DESCRIPTION	MCE/C	ADAC	MCE/P	EBOX	CODE
	FLOW SENSOR F3H13		•	•		60146290
	FLOW SENSOR F3H15		•	•		60146291

CABLE	DESCRIPTION	MCE/C	ADAC	MCE/P	EBOX	CODE
	PRESSURE SENSOR CABLE MCE 1 MT	•				60120929
	PRESSURE SENSOR CABLE MCE 2 MT	•				60145637
	PRESSURE SENSOR CABLE 4 MT.		•	•		88002310
	PRESSURE SENSOR CABLE 10 MT.		•	•		88002614
	PRESSURE SENSOR CABLE 32 MT.		•			88002615
	PRESSURE SENSOR CABLE 49 MT.		•			88002616
	PRESSURE SENSOR CABLE 99 MT.		•			88002620
	FLOW SENS. CABLE 2 MT.		•	•		60146292
	FLOW SENS. CABLE 4 MT.		•	•		88002311
	FLOW SENS. CABLE 10 MT.		•	•		88002617
	FLOW SENS. CABLE 32 MT.		•			88002618
	FLOW SENS. CABLE 49 MT.		•			88002619
	FLOW SENS. CABLE 99 MT.		•			88002621
	CABLE FOR ADAC CONNECTION		•			88002479
	CABLE X MCE TWIN CONNECT.	•		•		60144673
	MCE MODBUS CABLE KIT	•				60193518

# INVERTER ACCESSORIES

FLANGE FOR FLOW SENSOR	DESCRIPTION	MCE/C	ADAC	MCE/P	EBOX	CODE
	MOUNT. FLANGE FOR FLOW SENS. F3H13 PLAST. PIPE 2" (63 MM.)		•	•		88002228
	MOUNT. FLANGE FOR FLOW SENS. F3H13 PLAST. PIPE 2" 1/2(75MM.)		•	•		88002229
	MOUNT. FLANGE FOR FLOW SENS. F3H13 PLAST. PIPE 3" (90 MM.)		•	•		88002227
	MOUNT. FLANGE FOR FLOW SENS. F3H13 PLAST. PIPE 4" (110 MM.)		•	•		88002154
	MOUNT. FLANGE FOR FLOW SENS. F3H13 PLAST. PIPE 6" (160 MM.)		•	•		88002236
	MOUNT. FLANGE FOR FLOW SENS. F3H13 MET. PIPE 2" (60 MM.)		•	•		88002442
	MOUNT. FLANGE FOR FLOW SENS. F3H13 MET. PIPE 3" (88.9 MM.)		•	•		88002152
	MOUNT. FLANGE FOR FLOW SENS. F3H13 MET. PIPE 4" (114.3 MM.)		•	•		88002153
	MOUNT. FLANGE FOR FLOW SENS. F3H13 MET. PIPE 6" (168.3 MM.)		•	•		88002440
	MOUNT. FLANGE FOR FLOW SENS. F3H13 MET. PIPE 8" (219.1 MM.)		•	•		88002439

FLOATS	DESCRIPTION	MCE/C	ADAC	MCE/P	EBOX	SUNDRIVER	CODE
	FLOAT KEY	5 meters cable			•	•	159260030
		10 meters cable			•	•	159260040
		15 meters cable			•	•	159260050
		20 meters cable			•	•	159260070
	BULB-FLOAT	10 meters			•	•	002718000
		20 meters			•	•	002718001

LEVEL TRANSDUCER	DESCRIPTION	MCE/C	ADAC	MCE/P	EBOX	CODE
	PRESSURE TRASDUCER 0-5 MT- CABLE 20 MT. FOR E-BOX				•	60114675

LEVEL PROBE	DESCRIPTION	MCE/C	ADAC	MCE/P	EBOX	CODE
	<b>COMPLETE - ELECTRODE PROBE</b> Suitable for conductive liquids with a maximum temperature of +40°C To be connected with a 1,5 mm <sup>2</sup> cable - 550V insulation Sensibility ≤ 53 Kohm				•	002775000

# INVERTER ACCESSORIES

PRESSURE SWITCH	DESCRIPTION	MCE/C	ADAC	MCE/P	EBOX	CODE
	PRESSURE SWITCH FOR PROTECTION AGAINST DRY RUNNING				•	002717002

KIT CAPACITOR	DESCRIPTION	MCE/C	ADAC	MCE/P	EBOX	CODE
	KIT CAPACITOR 40UF				•	60169268
	KIT CAPACITOR 30UF				•	60169269
	KIT CAPACITOR 20UF				•	60169270

ALARM	DESCRIPTION	MCE/C	ADAC	MCE/P	EBOX	CODE
	FLASCHING 230V 5W 50/60 HZ				•	60169271

PRESSURE SENSOR	DESCRIPTION	MCE/C	ADAC	MCE/P	EBOX	CODE
	PRESS. TRAS. 16 BAR (EBOX for pressurization use)				•	60116837

# EVOSTA



Energy saving

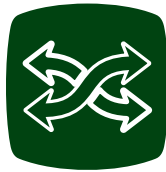

Ideal for replacement



Water resistant



Airvent plug

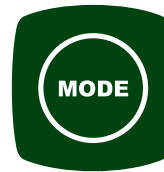

Easy user interface

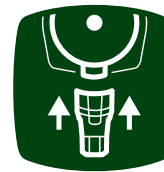

Easy connection





CIRCULATORS



DOWNLOAD  
TECHNICAL CATALOGUE



IN-LINE PUMPS



ELECTRONIC  
IN-LINE PUMPS



## EVOSTA 2

WET ROTOR ELECTRONIC  
CIRCULATORS



F7

PAG. 38



## EVOSTA 3

WET ROTOR ELECTRONIC  
CIRCULATORS



F8

PAG. 39



## EVOSTA 2 SOL

WET ROTOR ELECTRONIC  
CIRCULATORS



FA

PAG. 40



## EVOSTA 2 SAN V/R

WET ROTOR ELECTRONIC  
CIRCULATORS

FC

PAG. 41



## EVOSTA 2 SAN

WET ROTOR ELECTRONIC  
CIRCULATORS

F9

PAG. 41



## EVOPLUS SMALL

ELECTRONIC CIRCULATORS  
FOR SMALL COMMUNITY  
HEATING



EV

PAG. 42



## EVOPLUS

ELECTRONIC CIRCULATORS  
FOR HEATING AND  
AIR-CONDITIONING SYSTEMS



EW EU

PAG. 44



## VA

WET ROTOR  
CIRCULATORS



AZ

PAG. 47



## A / B / D

WET ROTOR  
CIRCULATORS



AV AW

PAG. 48



## BPH / DPH / BMH / DMH

WET ROTOR  
CIRCULATORS



AX

PAG. 50



## EVOPLUS SMALL SAN

ELECTRONIC CIRCULATORS  
FOR HEATING AND  
AIR-CONDITIONING SYSTEMS

EX

PAG. 52



## EVOPLUS SAN

ELECTRONIC CIRCULATORS  
FOR HEATING AND  
AIR-CONDITIONING SYSTEMS

EX

PAG. 53



## VS

WET ROTOR  
CIRCULATORS

B3

PAG. 54



## ALME / ALPE

ELECTRONIC  
IN-LINE PUMPS



BQ

PAG. 54



## KLME / KLPE DKLME / DKLPE

ELECTRONIC  
IN-LINE PUMPS



BV

PAG. 56



## CME / CM-GE DCME / DCM-GE

ELECTRONIC  
IN-LINE PUMPS



BW

PAG. 59



## CPE / CP-GE DCPE / DCP-GE

ELECTRONIC  
IN-LINE PUMPS



BW

PAG. 63



## ALM / ALP

IN-LINE PUMPS

BQ

PAG. 65



## KLM / KLP DKLM / DKLP

IN-LINE PUMPS

BR BS

PAG. 66



## CM / CM-G / DCM / DCM-G

IN-LINE PUMPS

BT BU

PAG. 68



## CP / CP-G / DCP / DCP-G

IN-LINE PUMPS

BT BU

PAG. 73



## K-HA

CENTRIFUGAL PRESSURE  
BOOSTING PUMPS

DO

PAG. 77



## ACCESSORIES

PAG. 79

## RANGE

# A new range for the market of tomorrow

43 years of experience. over 20 million circulators sold.

History and know-how, together with the in-house design of the mechanics and electronics and the new DAB 4.0 factory, make the new Evosta electronic wet rotor circulators utterly innovative.

in terms of technology, reliability and performance.



Only for EU markets

## IPX5 TESTING

The infiltration of moisture in the mechanics and, most importantly, in the electronics of our products is no longer an issue.

The IPX5 degree of protection is tested by firing a water jet from a 6.3 mm nozzle on weak spots and openings with no infiltration into the device.

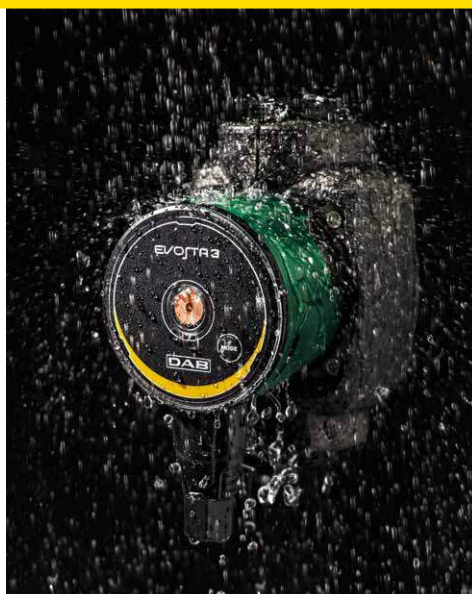











## IPX5

The waterproof electronics reduce faults to a minimum and ensure complete peace of mind.



## SELECTION GUIDE

					
	EVOSTA 3	EVOSTA 2	EVOSTA 2 SAN	EVOSTA 2 SAN	EVOSTA 2 SOL
					
5 Years Warranty (Only for EU markets)	•	•	•	•	•
Display	•				
Quick connection plug	•				
Proportional diff. press. regulation mode	•	•	•		•
Constant diff. press. regulation mode	•	•	•		
Fixed speed regulation mode	•	•	•	•	•
Dry run protection	•			•	
Auto-venting	•				
Airvent plug	•	•	•		•
Auto-unlock	•	•	•	•	•

# EVOSTA 2

## WET ROTOR ELECTRONIC CIRCULATORS



## EVOSTA 2

Evosta 2 by DAB is a wet rotor electronic circulator designed for the recirculation of water in domestic and residential heating and air conditioning systems.

Evosta 2 has a permanent magnet synchronous motor and inverter electronics that automatically adapt performance to system requirements, ensuring energy savings and protection from hammering effects.

With its compact size and all-round performance, it's the perfect replacement of old three-speed circulators. It combines the strength of the mechanical circulator with the benefits of the electronic one.

Its configuration is very simple: a sequential key can be used to scroll through the nine operating modes, three with proportional pressure, three with constant pressure and three with constant speed.

All the models have a breather plug and allow manual release of the motor shaft. Threaded suction and delivery ports. Technopolymer impeller. Cathaphoretic paint coated cast iron body, stainless steel motor casing. Water resistant electronics with IPX5 protection class.



### Operating range

0,4-3,6 m<sup>3</sup>/h with head up to 6,9 metres

**Pumped liquid temperature range**  
from -10 °C to +110°C

**Working pressure** 10 bar (1000 kPa)

**Protection class** IP X5

**Insulation class** F

**Installation** with horizontal motor axis

**Standard power input**  
single-phase 1x230 V~ 50/60 Hz

**Pumped liquid** Clean, free of solids and mineral oils, non-viscous, chemically neutral, with properties similar to water (glycol max 30%).



ACCESSORIES  
PAG. 79

MODEL	CODE	CENTRE DISTANCE mm	PUMP CONNECTIONS	ELECTRICAL DATA			HYDRAULIC DATA								EEI	WEIGHT KG	Q.TY x PALLET
				VOLTAGE 50/60 Hz	P1 MAX W	In A	Q=m <sup>3</sup> /h										
							0,0	0,3	0,6	0,9	1,8	2,4	3,0	3,6			
EVOSTA2 40-70/130 (1/2")	60186047	130	DN15 THREADED (G 1")	1x230V~	35	0,043 - 0,32	H (m)								≤ 0,18	1,86	276
EVOSTA2 40-70/130 (1")	60186046	130	DN25 THREADED (G 1" 1/2)	1x230V~	35	0,043 - 0,32	0	5	10	15	30	40	50	60	≤ 0,18	2,02	276
EVOSTA2 40-70/180 (1")	60185492	180	DN25 THREADED (G 1" 1/2)	1x230V~	35	0,043 - 0,32	0	5	10	15	30	40	50	60	≤ 0,18	2,19	198



# EVOSTA 3

## WET ROTOR ELECTRONIC CIRCULATORS



Evosta 3 by DAB is a wet rotor electronic circulator designed for the recirculation of water in domestic and residential heating and air conditioning systems.

It's the first circulator with IPX5 protection class. It has a permanent magnet synchronous motor and inverter electronics that automatically adapt performance to system requirements, ensuring energy savings and protection from hammering effects.

Its configuration is very simple: a sequential key can be used to scroll through the nine operating modes, three with proportional pressure, three with constant pressure and three with constant curve.

All the models have a breather plug, automatic degassing function and allow manual release of the motor shaft. Threaded suction and delivery ports. Technopolymer impeller. Insulation casings included. Cataphoretic paint coated cast iron body, stainless steel motor casing. Evosta 3 has a screen for the display of the height of the selected curve in metres, instantaneous power absorption in watts, instantaneous head and instantaneous flow rate. Thanks to the new standard interchangeable plug, Evosta 3 can be used with connectors of other brands without the need to redo the electrical connections.

### Operating range

0,4-4,2 m<sup>3</sup>/h with head up to 8+ metres

**Pumped liquid temperature range**  
from -10 °C to +110°C

**Working pressure** 10 bar (1000 kPa)

**Protection class** IP X5

**Insulation class** F

**Installation** with horizontal motor axis

**Standard power input**  
single-phase 1x230 V~ 50/60 Hz

**Pumped liquid** Clean, free of solids and mineral oils, non-viscous, chemically neutral, with properties similar to water (glycol max 30%)

## EVOSTA 3



ACCESSORIES  
PAG. 79

MODEL	CODE	CENTRE DISTANCE mm	PUMP CONNECTIONS	ELECTRICAL DATA			HYDRAULIC DATA											EEI	WEIGHT KG	Q.TY x PALLET	
				VOLTAGE 50/60 Hz	P1 MAX W	In A	Q=m <sup>3</sup> /h	0	0,4	0,6	0,9	1,2	1,8	2,1	2,9	≤ 0,17	2,05				168
							Q=l/min	0	6	10	15	20	30	35	48						
EVOSTA3 40/130 (1")	60186086	130	DN25 THREADED (G - 1" ½)	1x230 V~	20	0,034 - 0,18	H (m)	4,0	4,0	3,5	2,9	2,5	1,7	1,3	0,5	≤ 0,17	2,05	168			
EVOSTA3 40/180 (1")	60186077	180	DN25 THREADED (G - 1" ½)	1x230 V~	20	0,034 - 0,18		4,0	4,0	3,5	2,9	2,5	1,7	1,3	0,5	≤ 0,17	2,22	168			
EVOSTA3 40/180X (1"1/4)	60186078	180	DN32 THREADED (G - 2")	1x230 V~	20	0,034 - 0,18		4,0	4,0	3,5	2,9	2,5	1,7	1,3	0,5	≤ 0,17	2,38	168			

MODEL	CODE	CENTRE DISTANCE mm	PUMP CONNECTIONS	ELECTRICAL DATA			HYDRAULIC DATA											EEI	WEIGHT KG	Q.TY x PALLET	
				VOLTAGE 50/60 Hz	P1 MAX W	In A	Q=m <sup>3</sup> /h	0	0,6	1,2	1,5	2,1	2,4	3,0	3,6	≤ 0,18	2,05				168
							Q=l/min	0	9	20	25	35	40	50	60						
EVOSTA3 60/130 (1")	60186052	130	DN25 THREADED (G - 1" ½)	1x230 V~	35	0,042 - 0,33	H (m)	6,0	6,0	4,4	3,8	2,8	2,3	1,5	0,7	≤ 0,18	2,05	168			
EVOSTA3 60/180 (1")	60185506	180	DN25 THREADED (G - 1" ½)	1x230 V~	35	0,042 - 0,33		6,0	6,0	4,4	3,8	2,8	2,3	1,5	0,7	≤ 0,18	2,22	168			
EVOSTA3 60/180X (1"1/4)	60186079	180	DN32 THREADED (G - 2")	1x230 V~	35	0,042 - 0,33		6,0	6,0	4,4	3,8	2,8	2,3	1,5	0,7	≤ 0,18	2,38	168			

MODEL	CODE	CENTRE DISTANCE mm	PUMP CONNECTIONS	ELECTRICAL DATA			HYDRAULIC DATA											EEI	WEIGHT KG	Q.TY x PALLET	
				VOLTAGE 50/60 Hz	P1 MAX W	In A	Q=m <sup>3</sup> /h	0	0,6	0,9	1,2	2,7	3,3	3,9	4,2	≤ 0,19	2,05				168
							Q=l/min	0	10	15	20	45	55	65	70						
EVOSTA3 80/130 (1")	60186087	130	DN25 THREADED (G - 1" ½)	1x230 V~	55	0,053 - 0,47	H (m)	8,0	8,0	7,2	6,5	3,7	2,6	1,6	1,0	≤ 0,19	2,05	168			
EVOSTA3 80/180 (1")	60185505	180	DN25 THREADED (G - 1" ½)	1x230 V~	55	0,053 - 0,47		8,0	8,0	7,2	6,5	3,7	2,6	1,6	1,0	≤ 0,19	2,22	168			
EVOSTA3 80/180X (1"1/4)	60186085	180	DN32 THREADED (G - 2")	1x230 V~	55	0,053 - 0,47		8,0	8,0	7,2	6,5	3,7	2,6	1,6	1,0	≤ 0,19	2,38	168			

# EVOSTA 2 SOL

WET ROTOR ELECTRONIC CIRCULATORS



Evosta 2 Sol by DAB is a wet rotor electronic circulator designed for the recirculation of water in domestic and residential thermal solar panel heating and air conditioning systems.

It has a permanent magnet synchronous motor and inverter electronics that automatically adapt performance to system requirements, ensuring energy savings and protection from hammering effects. Its configuration is very simple: a sequential key can be used to scroll through the operating modes.

All the models have a breather plug and allow manual release of the motor shaft. Threaded suction and delivery ports.

Technopolymer impeller. Cataphoretic paint coated cast iron body, stainless steel motor casing.

A version controlled by PWM external signal (1.5 m plug cable) is also available. 1.5 m molex plug power cable.

## Operating range

0-4 m<sup>3</sup>/h with head up to 14,5 metres

## Pumped liquid temperature range

from -10 °C to +110 °C. (130 °C to 60 °C ambient)

## Working pressure

10 bar (1000 kPa)

## Protection class

IPX4

## Insulation class

F

## Installation

with horizontal motor axis

## Standard power input

single-phase 1x115-230 V ~ 50/60 Hz

## Power input connection

molex plug with 1.5m cable

## Pwm signal connector

plug with 1.5m cable (OEM versions only)

**Pumped liquid** Clean, free of solids and mineral oils, non-viscous, chemically neutral, with properties similar to water (glycol max 50%)

## EVOSTA 2



ACCESSORIES  
PAG. 79

MODEL	CODE	CENTRE DISTANCE mm	PUMP CONNECTIONS	ELECTRICAL DATA			HYDRAULIC DATA											EEI	WEIGHT KG	Q.TY x PALLET	
				VOLTAGE 50/60 Hz	P1 MAX W	In A	Q=m <sup>3</sup> /h		Q=l/min												
							0	0,5	1	1,5	2	2,5	3	3,5	4	0	8				16
EVOSTA2 20-75/130 SOL (1/2")	60188450	130	DN15 THREADED ( G 1" )	1x230 V ~	47	0,07-0,4	H (m)	7,5	7,5	6,2	5,1	4,2	3,4	2,5	1,7	0,9	≤ 0,20	1,91	198		
EVOSTA2 20-105/130 SOL (1/2")	60188451	130	DN15 THREADED ( G 1" )	1x230 V ~	48	0,055-0,4		10,5	9	6,8	5,4	4,1	3,2	2	0,8	≤ 0,20	1,91	198			
EVOSTA2 30-145/130 SOL (1/2")	60188452	130	DN15 THREADED ( G 1" )	1x230 V ~	59	0,07-0,5		14,3	10,2	8,2	6,2	5	3,8	2,2	1,2	≤ 0,20	1,91	198			
EVOSTA2 20-75/130 SOL (1")	60188404	130	DN25 THREADED ( G 1" 1/2 )	1x230 V ~	47	0,07-0,4		7,5	7,5	6,2	5,1	4,2	3,4	2,5	1,7	0,9	≤ 0,20	2,07	198		
EVOSTA2 20-75/180 SOL (1")	60188405	180	DN25 THREADED ( G 1" 1/2 )	1x230 V ~	47	0,07-0,4		7,5	7,5	6,2	5,1	4,2	3,4	2,5	1,7	0,9	≤ 0,20	2,24	198		
EVOSTA2 20-105/130 SOL (1")	60188421	130	DN25 THREADED ( G 1" 1/2 )	1x230 V ~	48	0,055-0,4		10,5	9	6,8	5,4	4,1	3,2	2	0,8	≤ 0,20	2,07	198			
EVOSTA2 20-105/180 SOL (1")	60188427	180	DN25 THREADED ( G 1" 1/2 )	1x230 V ~	48	0,055-0,4		10,5	9	6,8	5,4	4,1	3,2	2	0,8	≤ 0,20	2,24	198			
EVOSTA2 30-145/130 SOL (1")	60188429	130	DN25 THREADED ( G 1" 1/2 )	1x230 V ~	59	0,07-0,5		14,3	10,2	8,2	6,2	5	3,8	2,2	1,2	≤ 0,20	2,07	198			
EVOSTA2 30-145/180 SOL (1")	60188432	180	DN25 THREADED ( G 1" 1/2 )	1x230 V ~	59	0,07-0,5		14,3	10,2	8,2	6,2	5	3,8	2,2	1,2	≤ 0,20	2,24	198			

MODEL	CODE	CENTRE DISTANCE mm	PUMP CONNECTIONS	ELECTRICAL DATA			HYDRAULIC DATA											EEI	WEIGHT KG	Q.TY x PALLET	
				VOLTAGE 50/60 Hz	P1 MAX W	In A	Q=m <sup>3</sup> /h		Q=l/min												
							0	0,5	1	1,5	2	2,5	3	3,5	4	0	8				16
EVOSTA2 20-75/130 SOL PWM (1/2")	60188453	130	DN15 THREADED ( G 1" )	1x230 V ~	47	0,07-0,4	H (m)	7,5	7,5	6,2	5,1	4,2	3,4	2,5	1,7	0,9	≤ 0,20	1,96	198		
EVOSTA2 20-105/130 SOL PWM (1/2")	60188454	130	DN15 THREADED ( G 1" )	1x230 V ~	48	0,055-0,4		10,5	9	6,8	5,4	4,1	3,2	2	0,8	≤ 0,20	1,96	198			
EVOSTA2 30-145/130 SOL PWM (1/2")	60188455	130	DN15 THREADED ( G 1" )	1x230 V ~	59	0,07-0,5		14,3	10,2	8,2	6,2	5	3,8	2,2	1,2	≤ 0,20	1,96	198			
EVOSTA2 20-75/130 SOL PWM (1")	60188443	130	DN25 THREADED ( G 1" 1/2 )	1x230 V ~	47	0,07-0,4		7,5	7,5	6,2	5,1	4,2	3,4	2,5	1,7	0,9	≤ 0,20	2,12	198		
EVOSTA2 20-75/180 SOL PWM (1")	60188444	180	DN25 THREADED ( G 1" 1/2 )	1x230 V ~	47	0,07-0,4		7,5	7,5	6,2	5,1	4,2	3,4	2,5	1,7	0,9	≤ 0,20	2,29	198		
EVOSTA2 20-105/130 SOL PWM (1")	60188445	130	DN25 THREADED ( G 1" 1/2 )	1x230 V ~	48	0,055-0,4		10,5	9	6,8	5,4	4,1	3,2	2	0,8	≤ 0,20	2,12	198			
EVOSTA2 20-105/180 SOL PWM (1")	60188447	180	DN25 THREADED ( G 1" 1/2 )	1x230 V ~	48	0,055-0,4		10,5	9	6,8	5,4	4,1	3,2	2	0,8	≤ 0,20	2,29	198			
EVOSTA2 30-145/130 SOL PWM (1")	60188448	130	DN25 THREADED ( G 1" 1/2 )	1x230 V ~	59	0,07-0,5		14,3	10,2	8,2	6,2	5	3,8	2,2	1,2	≤ 0,20	2,12	198			
EVOSTA2 30-145/180 SOL PWM (1")	60188449	180	DN25 THREADED ( G 1" 1/2 )	1x230 V ~	59	0,07-0,5		14,3	10,2	8,2	6,2	5	3,8	2,2	1,2	≤ 0,20	2,29	198			

# EVOSTA 2 SAN V/R

WET ROTOR ELECTRONIC CIRCULATORS



Evosta 2 San by DAB is a wet rotor circulator designed for the recirculation of domestic hot water in small domestic and residential systems.

Synchronous motor. Threaded suction and delivery ports. Brass pump body.

V versions with fittings with built-in check valve and on-off ball valve; R versions with threads and without check valve and on-off ball valve. Significant energy savings: circulator consumption 7 W only.

### Operating range

0-0,6 m<sup>3</sup>/h with head up to 1,1 m

**Pumped liquid temperature range**  
from +2 °C to +75°C

**Working pressure** 10 bar (1000 kPa)

**Protection class** IP 42

**Insulation class** II

### Installation

with horizontal motor axis

### Standard power input

single-phase 1x115-230 V~ 50/60 Hz

**Pumped liquid** Clean, free of solids and mineral oils, non-viscous, chemically neutral, with properties similar to water (glycol max 30%)

## EVOSTA 2

ACCESSORIES  
PAG. 79

MODEL	CODE	CENTRE DISTANCE mm	PUMP CONNECTIONS	ELECTRICAL DATA			HYDRAULIC DATA							WEIGHT KG	Q.TY x PALLET	
				VOLTAGE 50/60 Hz	P1 MAX W	In A	Q=m <sup>3</sup> /h	0	0,1	0,2	0,3	0,4	0,5			0,6
EVOSTA2 11/85 SAN R1/2" CIRC.	60187267	85	INTERNAL THREAD G 1/2"	1x115-230 V~ 50/60 Hz	7	0,07	H (m)	1,1	1	0,87	0,73	0,58	0,4	0,23	1,06	200
EVOSTA2 11/139 SAN V CIRC.	60187268	139	EXTERNAL THREAD G 1"	1x115-230 V~ 50/60 Hz	7	0,07		1,1	0,93	0,76	0,59	0,4	0,23	0,7	1,26	200

F9

# EVOSTA 2 SAN

WET ROTOR ELECTRONIC CIRCULATORS



Evosta 2 San by DAB is a wet rotor electronic circulator designed for the recirculation of domestic hot water in domestic and residential systems.

It has a permanent magnet synchronous motor and inverter electronics that automatically adapt performance to system requirements, ensuring energy savings and protection from hammering effects.

Its configuration is very simple: a sequential key can be used to scroll through the nine operating modes, three with proportional pressure, three with constant pressure and three with constant speed curve.

All the models have a brass breather plug and allow manual release of the motor shaft. Threaded suction and delivery ports. Brass pump body. Electronics protected from water infiltrations; IPX5 protection class. No overload protection required.

### Operating range

0,4-4,2 m<sup>3</sup>/h with head up to 8 m

**Pumped liquid temperature range**  
from -10 °C to +110°C

**Working pressure** 10 bar (1000 kPa)

**Protection class** IP X5

**Insulation class** F

### Installation

with horizontal motor axis

### Standard power input

single-phase 1x230 V~ 50/60 Hz

**Pumped liquid** Clean, free of solids and mineral oils, non-viscous, chemically neutral, with properties similar to water (glycol max 30%)

## EVOSTA 2

ACCESSORIES  
PAG. 79

MODEL	CODE	CENTRE DISTANCE mm	PUMP CONNECTIONS	ELECTRICAL DATA			HYDRAULIC DATA							WEIGHT KG	Q.TY x PALLET	
				VOLTAGE 50/60 Hz	P1 MAX W	In A	Q=m <sup>3</sup> /h	0,0	0,9	1,8	2,4	3,0	3,6			4,2
EVOSTA2 40-70/150 SAN (1")	60186164	150	DN25 THREADED (G 1" ½)	1x230 V ~	35	0,043-0,32	H (m)	6,9	5,1	3,4	2,4	1,6	0,8		2,16	198
EVOSTA2 80/150 SAN (1")	60186588	150	DN25 THREADED (G 1" ½)	1x230 V ~	55	0,053-0,47		8	7,2	5,4	4,2	3,2	2,1	1	2,16	198

# EVOPLUS SMALL

ELECTRONIC CIRCULATORS FOR SMALL COMMUNITY HEATING



EVOPLUS SMALL electronic circulators can be used in heating, ventilation and air conditioning systems for residential and commercial buildings. In all correctly sized installations, the electronically controlled wet rotor pumps constantly ensure sufficient power and, simultaneously, lower noise emissions, greater comfort and a significant reduction in running costs. All models fitted with flanged pump body are available in both single and the twin versions. The user interface is easy to use and easy to understand.

**Circulator protection rate** IP 44.

**Insulation class** F.

**Standard voltage**

single-phase 220/240V, 50/60Hz.

**In accordance with European standards**

EN 61800-3 - EN 60335-1 - EN 60335-2-51.

**Operating range**

from 2 to 12 m<sup>3</sup>/h with head up to 11 meters.

**Liquid Temperature range**

from -10 °C to 110 °C.

**Pumped liquid** clean, free from solids and mineral oils, not viscous, chemically neutral, close to the properties of water (max. glycol contents 30%).

**Maximum working pressure** 16 bar (1600 kPa).

**Standard flanging** The single version is available with 1 1/2" and 2" threaded ports and with flanged ports DN 32 and DN 40, PN 6 / PN 10 / PN 16.

The twin version is available with flanged pump body DN 32 and DN 40, PN 6 / PN 10 / PN 16.

**Installation** with horizontal motor shaft.

EVOPLUS<sup>+</sup>  
SMALL

ErP  
ready

D+CONNECT

PAG. 5

ACCESSORIES  
PAG. 79

## SINGLE UNIONS

MODEL	CODE	CENTRE DISTANCE mm	PUMP COUPLINGS	UNIONS ON REQUEST		ELECTRICAL DATA			HYDRAULIC DATA								EEI PART 2	WEIGHT KG	Q.TY x PALLET
				STANDARDIS.	SPECIAL	VOLTAGE 50/60 Hz	P1 MAX W	In A	Q m <sup>3</sup> /h l/min	0	2,4	3	4,2	5,4	7,2	9,6			
EVOPLUS 40/180 M	60150938	180	1" 1/2	1" F	3/4" F - 1 1/4" M	220/240 V	70	0.52	H (m)	4,2	4,2	4	3,1	2,4			EEI ≤ 0,23	4,5	104
EVOPLUS 60/180 M	60150939	180	1" 1/2	1" F	3/4" F - 1 1/4" M	220/240 V	100	0.72		6,1	6,1	5,8	4,6	3,4			EEI ≤ 0,22	4,5	104
EVOPLUS 80/180 M	60150940	180	1" 1/2	1" F	3/4" F - 1 1/4" M	220/240 V	135	0.95		8,2	8,2	7,7	6,2	4,8	2,9		EEI ≤ 0,22	4,5	104
EVOPLUS 110/180 M	60150941	180	1" 1/2	1" F	3/4" F - 1 1/4" M	220/240 V	170	1.18		11,1	10,1	9,2	7,5	5,9	3,9		EEI ≤ 0,22	4,5	104
EVOPLUS 40/180 XM	60150942	180	2"	1 1/4" F		220/240 V	70	0.51		4,1	4,1	4	3,1	2,2			EEI ≤ 0,21	4,7	104
EVOPLUS 60/180 XM	60150943	180	2"	1 1/4" F		220/240 V	100	0.71		6,1	6,1	5,7	4,5	3,4			EEI ≤ 0,21	4,7	104
EVOPLUS 80/180 XM	60150944	180	2"	1 1/4" F		220/240 V	135	0.93		8,1	8,1	7,6	6,2	4,9	3		EEI ≤ 0,21	4,7	104
EVOPLUS 110/180 XM	60150945	180	2"	1 1/4" F		220/240 V	170	1.18		11,3	10,2	9,5	7,9	6,3	4,3	2	EEI ≤ 0,21	4,7	104

## SINGLE WITH FLANGES

MODEL	CODE	CENTRE DISTANCE mm	COUNTERFLANG. ON REQUEST	ELECTRICAL DATA			HYDRAULIC DATA								EEI PART 2	WEIGHT KG	Q.TY x PALLET	
				VOLTAGE 50/60 Hz	P1 MAX W	In A	Q m <sup>3</sup> /h l/min	0	2,4	3	4,2	5,4	7,2	9,6				
DN 32	EVOPLUS B 40/220.32 M	60150946	DN32 PN 6	220/240 V	85	0.55	H (m)	4,2	4,2	4,2	3,3	2,5	1,3			EEI ≤ 0,22	7,5	51
	EVOPLUS B 60/220.32 M	60150947	DN32 PN 6	220/240 V	110	0.75		6,1	6,1	5,6	4,6	3,6	2,2			EEI ≤ 0,22	7,5	51
	EVOPLUS B 80/220.32 M	60150948	DN32 PN 6	220/240 V	150	0.97		8	8	7,3	6	4,9	3,3			EEI ≤ 0,22	7,5	51
	EVOPLUS B 110/220.32 M	60150949	DN32 PN 6	220/240 V	200	1.3		11,2	10,5	9,6	8,1	6,8	5	2,6		EEI ≤ 0,22	7,5	51
DN 40	EVOPLUS B 40/250.40 M	60150950	DN40 PN 10	220/240 V	75	0.55	H (m)	4,2	4,2	4,2	3,3	2,5	1,3			EEI ≤ 0,21	7,5	51
	EVOPLUS B 60/250.40 M	60150951	DN40 PN 10	220/240 V	105	0.75		6,1	6,1	5,6	4,6	3,6	2,2			EEI ≤ 0,21	7,5	51
	EVOPLUS B 80/250.40 M	60150952	DN40 PN 10	220/240 V	140	0.97		8	8	7,3	6	4,9	3,3			EEI ≤ 0,21	7,5	51
	EVOPLUS B 110/250.40 M	60150953	DN40 PN 10	220/240 V	190	1.3		11,2	10,5	9,6	8,1	6,8	5	2,6		EEI ≤ 0,21	7,5	51

# EVOPLUS SMALL

ELECTRONIC CIRCULATORS FOR SMALL COMMUNITY HEATING



## TWIN FLANGED

	MODEL	CODE	CENTRE DISTANCE mm	COUNTERFLANG. ON REQUEST	ELECTRICAL DATA			Q m <sup>3</sup> /h l/min	HYDRAULIC DATA								EEI PART 2	WEIGHT KG	Q.TY x PALLET
					VOLTAGE 50/60 Hz	P1 MAX W	In A		0	2,4	3	4,2	5,4	7,2	9,6				
DN 32	EVOPLUS D 40/220.32 M	60150954	220	DN32 PN 6	220/240 V	85	0.55	H (m)	0	2,4	3	4,2	5,4	7,2	9,6	EEI ≤ 0,23	13,5	30	
	EVOPLUS D 60/220.32 M	60150955	220	DN32 PN 6	220/240 V	110	0.75		0	40	50	70	90	120	160	EEI ≤ 0,23	13,5	30	
	EVOPLUS D 80/220.32 M	60150956	220	DN32 PN 6	220/240 V	150	0.95		8	8	7,3	6	4,9	3,3		EEI ≤ 0,23	13,5	30	
	EVOPLUS D 110/220.32 M	60150957	220	DN32 PN 6	220/240 V	200	1.3		11,2	10,5	9,6	8,1	6,8	5	2,6	EEI ≤ 0,23	13,5	30	
DN 40	EVOPLUS D 40/250.40 M	60150958	250	DN40 PN 10	220/240 V	75	0.55	H (m)	0	2,4	3	4,2	5,4	7,2	9,6	EEI ≤ 0,22	14,2	30	
	EVOPLUS D 60/250.40 M	60150959	250	DN40 PN 10	220/240 V	100	0.75		0	40	50	70	90	120	160	EEI ≤ 0,22	14,2	30	
	EVOPLUS D 80/250.40 M	60150960	250	DN40 PN 10	220/240 V	135	0.95		8	8	7,3	6	4,9	3,3		EEI ≤ 0,22	14,2	30	
	EVOPLUS D 110/250.40 M	60150961	250	DN40 PN 10	220/240 V	190	1.3		11,2	10,5	9,6	8,1	6,8	5	2,6	EEI ≤ 0,22	14,2	30	

COMMAND AND CONTROL SYSTEMS

CIRCULATORS AND IN-LINE PUMPS

MULTISTAGE CENTRIFUGAL AND SELF-PRIMING PUMPS

SWIMMING POOL, POND AND SALT WATER PUMPS

CENTRIFUGAL PUMPS

SUBMERSIBLE PUMPS

SUBMERSIBLE PUMPS AND SUBMERSIBLE MOTORS

PRESSURE UNITS

# EVOPLUS

ELECTRONIC CIRCUATORS FOR HEATING AND AIR-CONDITIONING SYSTEMS



EVOPLUS electronic circulators can be used in heating, ventilation and air conditioning systems for residential and commercial buildings. In all correctly sized installations, the electronically controlled wet rotor pumps constantly ensure sufficient power and, simultaneously, lower noise emissions, greater comfort and a significant reduction in running costs. All models fitted with flanged pump body are available in both single and twin versions. The user interface is easy to use and easy to understand.

- Circulator protection rate** IP 44.
- Insulation class** F.
- Standard voltage**  
single-phase 220/240V, 50/60Hz.
- In accordance with European standards**  
EN 61800-3 - EN 60335-1 - EN 60335-2-51.
- Operating range**  
from 2 to 75.6 m³/h with head up to 18 metres.
- Liquid Temperature range**  
from -10 °C to 110 °C.
- Pumped liquid** clean, free from solids and mineral oils, not viscous, chemically neutral, close to the properties of water (max. glycol contents 30%).
- Maximum working pressure** 16 bar (1600 kPa).
- Standard flanging**  
DN 32, DN 40, DN 50, DN 65, PN 6/ PN 10/ PN 16 (4 slots), DN 80 e DN 100, PN 6 (4 slots) usable with flange 4 holes PN10.
- Special version on demand**  
DN 80, DN 100 PN 10/ PN 16 (8 holes)
- Installation** with horizontal motor shaft.



# EVOPLUS



ACCESSORIES  
PAG. 79

## SINGLE WITH FLANGES

MODEL	CODE	CENTRE DISTANCE mm	COUNTERFL. ON REQUEST	ELECTRICAL DATA			HYDRAULIC DATA															EEI PART 2	WEIGHT KG	Q.TY x PALLET			
				VOLTAGE 50/60 Hz	P1 MAX W	In A	Q m³/h	0	4,2	5,4	7,2	9,6	12	14,4	18	24	30	36	42	54	72						
DN 32	EVOPLUS B 120/220.32 M	60150962	220	DN32 PN 6	220/240 V	340	1,7	H (m)	0	70	90	120	160	200	240	300	400	500	600	700	900	1200	EEI ≤ 0,22	24	16		
DN 40	EVOPLUS B 40/220.40 M	60150963	220	DN40 PN 10	220/240 V	90	0,7	H (m)	4	3,6	3,1	2,5	1,7												EEI ≤ 0,23	20,8	16
	EVOPLUS B 60/220.40 M	60150964	220	DN40 PN 10	220/240 V	175	1	H (m)	6																EEI ≤ 0,23	20,8	16
	EVOPLUS B 80/220.40 M	60150965	220	DN40 PN 10	220/240 V	260	1,35	H (m)	8																EEI ≤ 0,21	20,8	16
	EVOPLUS B 100/220.40 M	60150966	220	DN40 PN 10	220/240 V	350	1,75	H (m)	10																EEI ≤ 0,20	20,8	16
	EVOPLUS B 120/250.40 M	60150967	250	DN40 PN 10	220/240 V	465	2,2	H (m)	12																EEI ≤ 0,20	20	16
	EVOPLUS B 150/250.40 M	60150968	250	DN40 PN 10	220/240 V	610	2,9	H (m)	15																EEI ≤ 0,20	20	16
EVOPLUS B 180/250.40 M	60150969	250	DN40 PN 10	220/240 V	610	2,9	H (m)	18																EEI ≤ 0,20	20	16	
DN 50	EVOPLUS B 40/240.50 M	60150970	240	DN50 PN 10	220/240 V	140	0,87	H (m)	4															EEI ≤ 0,23	21,4	16	
	EVOPLUS B 60/240.50 M	60150971	240	DN50 PN 10	220/240 V	260	1,35	H (m)	6															EEI ≤ 0,21	21,4	16	
	EVOPLUS B 80/240.50 M	60150972	240	DN50 PN 10	220/240 V	330	0,87	H (m)	8															EEI ≤ 0,21	21,4	16	
	EVOPLUS B 100/280.50 M	60150973	280	DN50 PN 10	220/240 V	430	2,1	H (m)	10															EEI ≤ 0,20	22	16	
	EVOPLUS B 120/280.50 M	60150974	280	DN50 PN 10	220/240 V	530	2,5	H (m)	12															EEI ≤ 0,19	21,8	16	
	EVOPLUS B 150/280.50 M	60150975	280	DN50 PN 10	220/240 V	640	3	H (m)	15,3															EEI ≤ 0,19	22,8	16	
EVOPLUS B 180/280.50 M	60150976	280	DN50 PN 10	220/240 V	750	3,45	H (m)	17,1															EEI ≤ 0,19	22,8	16		
DN 65	EVOPLUS B 40/340.65 M	60150977	340	DN65 PN 10	220/240 V	190	1,1	H (m)	4															EEI ≤ 0,21	23,8	8	
	EVOPLUS B 60/340.65 M	60150978	340	DN65 PN 10	220/240 V	355	1,8	H (m)	6															EEI ≤ 0,20	23,8	8	
	EVOPLUS B 80/340.65 M	60150979	340	DN65 PN 10	220/240 V	465	2,2	H (m)	8															EEI ≤ 0,19	24,6	8	
	EVOPLUS B 100/340.65 M	60150980	340	DN65 PN 10	220/240 V	590	2,8	H (m)	10,1															EEI ≤ 0,18	25	8	
	EVOPLUS B 120/340.65 M	60150981	340	DN65 PN 10	220/240 V	730	3,45	H (m)	12															EEI ≤ 0,18	24,6	8	
	EVOPLUS B 150/340.65 M	60150986	340	DN65 PN 10	220/240 V	1210	5,5	H (m)	15,2															EEI ≤ 0,18	27	8	
DN 80	EVOPLUS B 40/360.80 M	60150987	360	DN80 PN 10	220/240 V	330	1,65	H (m)	4														EEI ≤ 0,19	30,2	8		
	EVOPLUS B 60/360.80 M	60150988	360	DN80 PN 10	220/240 V	535	2,5	H (m)	6														EEI ≤ 0,20	30,2	8		
	EVOPLUS B 80/360.80 M	60150989	360	DN80 PN 10	220/240 V	670	3	H (m)	8														EEI ≤ 0,20	32	8		
	EVOPLUS B 100/360.80 M	60150990	360	DN80 PN 10	220/240 V	1005	4,5	H (m)	10														EEI ≤ 0,19	32,2	4		
	EVOPLUS B 120/360.80 M	60150991	360	DN80 PN 10	220/240 V	1235	5,5	H (m)	12,1														EEI ≤ 0,19	32,2	4		
DN 100	EVOPLUS B 40/450.100 M	60150992	450	DN100 PN 10	220/240 V	530	2,5	H (m)	4														EEI ≤ 0,19	37,5	4		
	EVOPLUS B 60/450.100 M	60150993	450	DN100 PN 10	220/240 V	760	3,5	H (m)	6														EEI ≤ 0,18	37,5	4		
	EVOPLUS B 80/450.100 M	60150994	450	DN100 PN 10	220/240 V	1080	4,8	H (m)	8														EEI ≤ 0,18	36,6	4		
	EVOPLUS B 100/450.100 M	60150995	450	DN100 PN 10	220/240 V	1380	6	H (m)	10,1														EEI ≤ 0,19	36,8	4		
	EVOPLUS B 120/450.100 M	60150999	450	DN100 PN 10	220/240 V	1560	7	H (m)	12,2														EEI ≤ 0,19	36,3	4		

# EVOPLUS

ELECTRONIC CIRCULATORS FOR HEATING AND AIR-CONDITIONING SYSTEMS



## SPECIAL VERSION TWIN FLANGED PN 16

MODEL	CODE	CENTRE DISTANCE mm	COUNTERFL. ON REQUEST	ELECTRICAL DATA			HYDRAULIC DATA												EEI PART 2	WEIGHT KG	Q.TY x PALLET	
				VOLTAGE 50/60 Hz	P1 MAX W	In A	Q m³/h	H (m)														
								0	18	24	30	36	42	54	72							
DN 80	EVOPLUS B 40/360.80 M	60153017	360	DN80 PN 16	220/240 V	330	1,65	4	4	3,1	2,2	1,4						EEI ≤ 0,19	30,2	8		
	EVOPLUS B 60/360.80 M	60153018	360	DN80 PN 16	220/240 V	535	2,5	6	6	5,2	4	3	2					EEI ≤ 0,20	30,2	8		
	EVOPLUS B 80/360.80 M	60153019	360	DN80 PN 16	220/240 V	670	3	8	8	6,7	5,4	4,2	3,2					EEI ≤ 0,20	32	8		
	EVOPLUS B 100/360.80 M	60153020	360	DN80 PN 16	220/240 V	1005	4,5	10		9,7	8,3	6,7	5,4	3				EEI ≤ 0,19	32,2	4		
	EVOPLUS B 120/360.80 M	60153021	360	DN80 PN 16	220/240 V	1235	5,5	12,1		11,6	9,9	8,3	6,8	4,1				EEI ≤ 0,19	32,2	4		
DN 100	EVOPLUS B 40/450.100 M	60153022	450	DN100 PN 16	220/240 V	530	2,5	4				3,9	3	2				EEI ≤ 0,19	37,5	4		
	EVOPLUS B 60/450.100 M	60153023	450	DN100 PN 16	220/240 V	760	3,5	6				5,7	4,7	3,6	1,3			EEI ≤ 0,18	37,5	4		
	EVOPLUS B 80/450.100 M	60153024	450	DN100 PN 16	220/240 V	1080	4,8	8				8	7,2	5,7	3,4			EEI ≤ 0,18	36,6	4		
	EVOPLUS B 100/450.100 M	60153025	450	DN100 PN 16	220/240 V	1380	6	10,1				10,1	9,2	7,6	4,9	0,7		EEI ≤ 0,19	36,8	4		
	EVOPLUS B 120/450.100 M	60153026	450	DN100 PN 16	220/240 V	1560	7	12,2				11,8	10,4	8,7	5,9	1,5		EEI ≤ 0,19	36,3	4		



## TWIN FLANGED

MODEL	CODE	CENTRE DISTANCE mm	COUNTERFL. ON REQUEST	ELECTRICAL DATA			HYDRAULIC DATA																EEI PART 2	WEIGHT KG	Q.TY x PALLET				
				VOLTAGE 50/60 Hz	P1 MAX W	In A	Q m³/h	H (m)																					
								0	4,2	5,4	7,2	9,6	12	14,4	18	24	30	36	42										
DN 32	EVOPLUS D 120/220.32 M	60151000	220	DN32 PN 6	220/240 V	340	1,7	12,1	11,5	10,7	9,5	7,9	6,3	4,7	2,2											EEI ≤ 0,22	36,2	4	
DN 40	EVOPLUS D 40/220.40 M	60151001	220	DN40 PN 10	220/240 V	90	0,7	4	3,6	3,1	2,5	1,7														EEI ≤ 0,23	38,6	4	
	EVOPLUS D 60/220.40 M	60151002	220	DN40 PN 10	220/240 V	175	1	6		5,9	5,1	4,1	3	2												EEI ≤ 0,23	38,6	4	
	EVOPLUS D 80/220.40 M	60151003	220	DN40 PN 10	220/240 V	260	1,35	8		7,9	7,4	6,1	5	3,7	2											EEI ≤ 0,23	38,6	4	
	EVOPLUS D 100/220.40 M	60151004	220	DN40 PN 10	220/240 V	350	1,75	10				9,7	8,3	7	5,5	3,5											EEI ≤ 0,23	38,6	4
	EVOPLUS D 120/250.40 M	60151005	250	DN40 PN 10	220/240 V	465	2,2	12				11,5	10,1	8,7	7,3	5,2											EEI ≤ 0,23	38,8	4
	EVOPLUS D 150/250.40 M	60151006	250	DN40 PN 10	220/240 V	610	2,9	15				14,5	12,8	11,3	9,7	7,5	3,8										EEI ≤ 0,23	38,8	4
	EVOPLUS D 180/250.40 M	60151007	250	DN40 PN 10	220/240 V	610	2,9	18				16,2	14,6	13	11,2	9,6	7,4	3,9									EEI ≤ 0,23	38,8	4
DN 50	EVOPLUS D 40/240.50 M	60151008	240	DN50 PN 10	220/240 V	140	0,87	4			3,9	3,6	3,1	2,6	2,1	1,4											EEI ≤ 0,23	40	4
	EVOPLUS D 60/240.50 M	60151009	240	DN50 PN 10	220/240 V	260	1,35	6					5,4	4,7	4	3,2	1,6										EEI ≤ 0,22	40	4
	EVOPLUS D 80/240.50 M	60151010	240	DN50 PN 10	220/240 V	330	1,7	8				7,4	6,6	5,9	5,2	4,2	2,6										EEI ≤ 0,22	40	4
	EVOPLUS D 100/280.50 M	60151011	280	DN50 PN 10	220/240 V	430	2,1	10				9,4	8,4	7,5	6,7	5,5	3,6	2									EEI ≤ 0,22	39,4	4
	EVOPLUS D 120/280.50 M	60151012	280	DN50 PN 10	220/240 V	530	2,5	12					11	9,9	9	8,2	6,9	4,8	3								EEI ≤ 0,22	39,6	4
	EVOPLUS D 150/280.50 M	60151013	280	DN50 PN 10	220/240 V	640	3	15,3				12,4	11,5	10,6	9,6	8,3	6,2	4,2									EEI ≤ 0,21	41,6	4
	EVOPLUS D 180/280.50 M	60151014	280	DN50 PN 10	220/240 V	750	3,45	17,1					14	13	12	11,1	9,7	7,4	5,2	3,1							EEI ≤ 0,21	41,6	4
DN 65	EVOPLUS D 40/340.65 M	60151015	340	DN65 PN 10	220/240 V	190	1,1	4				4	3,8	3,4	3	2,4	1,4										EEI ≤ 0,21	43,4	4
	EVOPLUS D 60/340.65 M	60151016	340	DN65 PN 10	220/240 V	355	1,8	6					6	5,9	5,4	4,7	3,7	2,2									EEI ≤ 0,21	43,4	4
	EVOPLUS D 80/340.65 M	60151017	340	DN65 PN 10	220/240 V	465	2,2	8					7,8	7,4	6,8	5,9	4,6	3,5	2								EEI ≤ 0,21	43,4	4
	EVOPLUS D 100/340.65 M	60151018	340	DN65 PN 10	220/240 V	590	2,8	10,1					9,8	9,1	8,4	7,6	6,1	4,7	3,1								EEI ≤ 0,20	44,8	4
	EVOPLUS D 120/340.65 M	60151019	340	DN65 PN 10	220/240 V	730	3,45	12						11,5	10,8	10	9	7,4	5,9	4,6	2,8						EEI ≤ 0,20	45	4
	EVOPLUS D 150/340.65 M	60151020	340	DN65 PN 10	220/240 V	1210	5,5	15,2							14,9	14,7	14	12,1	10,3	8,5	6,9						EEI ≤ 0,20	49,4	4

# EVOPLUS

ELECTRONIC CIRCULATORS FOR HEATING AND AIR-CONDITIONING SYSTEMS



## TWIN FLANGED

	MODEL	CODE	CENTRE DISTANCE mm	COUNTERFL. ON REQUEST	ELECTRICAL DATA			HYDRAULIC DATA												EEI PART 2	WEIGHT KG	Q.TY x PALLET
					VOLTAGE 50/60 Hz	P1 MAX W	In A	Q m <sup>3</sup> /h	0	12	14,4	18	24	30	36	42	54	72				
DN 80	EVOPLUS D 40/360.80 M	60151021	360	DN80 PN 10	220/240 V	330	1,65	4					4	3,1	2,2	1,4				EEI ≤ 0,20	52	4
	EVOPLUS D 60/360.80 M	60151022	360	DN80 PN 10	220/240 V	535	2,5	6					6	5,2	4	3	2			EEI ≤ 0,20	52	4
	EVOPLUS D 80/360.80 M	60151023	360	DN80 PN 10	220/240 V	670	3	8					8	6,7	5,4	4,2	3,2			EEI ≤ 0,20	57	4
	EVOPLUS D 100/360.80 M	60151024	360	DN80 PN 10	220/240 V	1005	4,5	10					10	9,7	8,3	6,7	5,4	3		EEI ≤ 0,19	56	4
	EVOPLUS D 120/360.80 M	60151025	360	DN80 PN 10	220/240 V	1235	5,5	12,1					12,1	11,6	9,9	8,3	6,8	4,1		EEI ≤ 0,19	56,4	4
DN 100	EVOPLUS D 40/450.100 M	60151026	450	DN100 PN 10	220/240 V	530	2,5	4							3,9	3	2			EEI ≤ 0,19	67,8	4
	EVOPLUS D 60/450.100 M	60151027	450	DN100 PN 10	220/240 V	760	3,5	6							5,7	4,7	3,6	1,3		EEI ≤ 0,19	67,8	4
	EVOPLUS D 80/450.100 M	60151028	450	DN100 PN 10	220/240 V	1080	4,8	8					8	7,2	5,7	3,4			EEI ≤ 0,20	68	4	
	EVOPLUS D 100/450.100 M	60151029	450	DN100 PN 10	220/240 V	1380	6	10,1					10,1	9,2	7,6	4,9	0,7		EEI ≤ 0,20	68	2	
	EVOPLUS D 120/450.100 M	60151030	450	DN100 PN 10	220/240 V	1560	7	12,2					12,2	11,8	10,4	8,7	5,9	1,5	EEI ≤ 0,20	67,8	2	

## SPECIAL VERSION TWIN FLANGED PN 16

	MODEL	CODE	CENTRE DISTANCE mm	COUNTERFL. ON REQUEST	ELECTRICAL DATA			HYDRAULIC DATA												EEI PART 2	WEIGHT KG	Q.TY x PALLET
					VOLTAGE 50/60 Hz	P1 MAX W	In A	Q m <sup>3</sup> /h	0	18	24	30	36	42	54	72						
DN 80	EVOPLUS D 40/360.80 M	60153028	360	DN80 PN 16	220/240 V	330	1,65	4	4	3,1	2,2	1,4							EEI ≤ 0,20	52	4	
	EVOPLUS D 60/360.80 M	60153029	360	DN80 PN 16	220/240 V	535	2,5	6	6	5,2	4	3	2						EEI ≤ 0,20	52	4	
	EVOPLUS D 80/360.80 M	60153030	360	DN80 PN 16	220/240 V	670	3	8	8	6,7	5,4	4,2	3,2						EEI ≤ 0,20	57	4	
	EVOPLUS D 100/360.80 M	60153031	360	DN80 PN 16	220/240 V	1005	4,5	10			9,7	8,3	6,7	5,4	3				EEI ≤ 0,19	56	4	
	EVOPLUS D 120/360.80 M	60153032	360	DN80 PN 16	220/240 V	1235	5,5	12,1			11,6	9,9	8,3	6,8	4,1				EEI ≤ 0,19	56,4	4	
DN 100	EVOPLUS D 40/450.100 M	60153033	450	DN100 PN 16	220/240 V	530	2,5	4					3,9	3	2				EEI ≤ 0,19	67,8	4	
	EVOPLUS D 60/450.100 M	60153034	450	DN100 PN 16	220/240 V	760	3,5	6					5,7	4,7	3,6	1,3			EEI ≤ 0,19	67,8	4	
	EVOPLUS D 80/450.100 M	60153035	450	DN100 PN 16	220/240 V	1080	4,8	8					8	7,2	5,7	3,4			EEI ≤ 0,20	68	4	
	EVOPLUS D 100/450.100 M	60153036	450	DN100 PN 16	220/240 V	1380	6	10,1					10,1	9,2	7,6	4,9	0,7		EEI ≤ 0,20	68	2	
	EVOPLUS D 120/450.100 M	60153037	450	DN100 PN 16	220/240 V	1560	7	12,2					12,2	11,8	10,4	8,7	5,9	1,5	EEI ≤ 0,20	67,8	2	



## VA

## WET ROTOR CIRCULATORS



Single body consisting of a cast iron hydraulic unit. Die-cast aluminium motor casing. Technopolymer impeller. Alumina driving shaft mounted on graphite brushings lubricated by the pumped liquid itself. Stainless steel protective rotor sleeve, stator sleeve and closing flange. Ceramic thrust bearing, E.P.D.M. O-rings and brass air outlet cap. The two-pole asynchronous motor with wet rotor is self-protected for resistance.  
**No overload protection required. Three-speed operation.**

**Operating range**

from 0.5 to 3,6 m<sup>3</sup>/h with head up to 6 metres.

**Liquid temperature range**

from -10°C to +110°C.

**Pumped liquid characteristics** clean, free from solids and mineral oils, non viscous, chemically neutral, close to the characteristics of water (max 30% glycol).

**Maximum working pressure**

10 bar (1000 kPa).

**Protection level** corresponding to IP 44

**Insulation class** F

**Cable grommet** PG 11

**Installation** with motor axis horizontal.

Only for extra EU markets. Please contact our sales network for more information

ONLY FOR  
EXTRA EU  
MARKETS

ACCESSORIES  
PAG. 79

## VA SINGLE WITH UNIONS

MODEL	CODE	CENTRE DISTANCE mm	PUMP COUPLINGS	ELECTRICAL DATA			ENERGY CLASS	HYDRAULIC DATA								WEIGHT KG	Q.TY x PALLET
				VOLTAGE 50 Hz	P1 MAX W	In A		Q m <sup>3</sup> /h l/min	0	0,6	1,2	1,8	2,4	3	4,2		
VA 25/130	60182197	130	1 1/2" G	1x230V	43	0,19	B	H (m)	2,71	2,45	2,15	1,75	1,2	0,6		2,7	240
VA 25/180	60182196	180	1 1/2" G	1x230V	43	0,19	B		2,71	2,45	2,15	1,75	1,2	0,6		2,8	180
VA 25/180 X	60182195	180	2" G	1x230V	43	0,19	B		2,71	2,45	2,15	1,75	1,2	0,6		2,9	180
VA 35/130	60182186	130	1 1/2" G	1x230V	56	0,25	B		4,3	3,9	3,4	2,8	2,15	1,4		2,7	240
VA 35/130 1/2"	60182184	130	1" G	1x230V	56	0,25	B		4,3	3,9	3,4	2,8	2,15	1,4		2,6	240
VA 35/180	60182183	180	1 1/2" G	1x230V	56	0,25	B		4,3	3,9	3,4	2,8	2,15	1,4		2,8	180
VA 35/180 X	60182180	180	2" G	1x230V	56	0,25	B		4,3	3,9	3,4	2,8	2,15	1,4		2,9	180
VA 55/130	60182179	130	1 1/2" G	1x230V	70	0,30	B		5,4	4,7	4,5	3,3	2,6	1,75	0,85	2,7	240
VA 55/130 1/2"	60182175	130	1" G	1x230V	70	0,30	B		5,4	4,7	4,5	3,3	2,6	1,75	0,85	2,6	240
VA 55/180	60182171	180	1 1/2" G	1x230V	70	0,30	B		5,4	4,7	4,5	3,3	2,6	1,75	0,85	2,8	180
VA 55/180 X	60182170	180	2" G	1x230V	70	0,30	B		5,4	4,7	4,5	3,3	2,6	1,75	0,85	2,9	180
VA 65/130	60182169	130	1 1/2" G	1x230V	78	0,34	C		6,3	5,8	5,3	4,3	3,4	2,4		2,7	240
VA 65/130 1/2"	60182168	130	1" G	1x230V	78	0,34	C		6,3	5,8	5,3	4,3	3,4	2,4		2,6	240
VA 65/180	60181676	180	1 1/2" G	1x230V	78	0,34	C		6,3	5,8	5,3	4,3	3,4	2,4		2,7	180
VA 65/180 X	60182167	180	2" G	1x230V	78	0,34	C		6,3	5,8	5,3	4,3	3,4	2,4		2,9	180

# A - B - D

## WET ROTOR CIRCULATORS



Pump body in cast iron and motor casing in die-cast aluminium. Technopolymer impeller and tempered stainless steel driving shaft mounted on graphite brushings lubricated by the pumped liquid itself. Flanged vents, (threaded series A), provided with threaded connectors for controlling gauges. Stainless steel protective rotor sleeve, stator sleeve and closing flange. Ceramic thrust bearing, E.P.D.M. "O" rings and brass air outlet cap. The two-pole asynchronous motor with wet rotors designed for **three-speed** operation, single-phase version, for **two-speed** operation, for three-phase version. Thermal overload protection incorporated in the single phase version. In the twin version an automatic clapet type valve and blank flange are provided.

### Operating range

from 1 to 12 m<sup>3</sup>/h with head up to 11 metres.

### Liquid temperature range

from -10°C to +110°C.

**Pumped liquid characteristics** clean, free from solids and mineral oils, not viscous, chemically neutral, close to the characteristics of water (max 30% glycol).

**Maximum working pressure** 10 bar (1000 kPa).

**Protection level** IP 44

**Insulation class** F

**Cable grommet** PG 11

**Installation** with motor axis horizontal.

Only for extra EU markets. Please contact our sales network for more information

ONLY FOR  
EXTRA EU  
MARKETS

ACCESSORIES  
PAG. 79

## A SINGLE WITH UNIONS

MODEL	CODE	CENTRE DISTANCE mm	PUMP COUPLINGS	ELECTRICAL DATA			HYDRAULIC DATA												WEIGHT KG	Q.TY x PALLET
				VOLTAGE 50 Hz	P1 MAX W	In A	Q m <sup>3</sup> /h l/min	0	0,6	1,2	1,8	2,4	3	4,2	7,2	12				
A 50/180 M	505803001	180	1 1/2"G	1 x 230V ~	195	0,95	H (m)	5,7	5,6	5,4	5,3	5,1	4,8	4,2	2,6		5,3	115		
A 50/180 XM	505802041	180	2"G	1 x 230V ~	189	0,92		5,7	5,6	5,4	5,3	5,1	4,8	4,2	2,6		5,0	115		
A 50/180 T	505803601	180	1 1/2"G	3x400V ~	197	0,52		5,6	5,6	5,6	5,5	5,43	5,4	4,9	2,8		5,2	115		
A 50/180 XT	505802671	180	2"G	3x400V ~	201	0,50		5,9	5,85	5,8	5,6	5,5	5,2	4,6	2,9		5,3	115		
A 56/180 M	505805001	180	1 1/2"G	1 x 230V ~	287	1,30		6,35	6,3	6,2	6,18	6	5,9	5,5	4,2	1,2	5,3	115		
A 56/180 XM	505804041	180	2"G	1 x 230V ~	294	1,32		6,35	6,3	6,2	6,18	6	5,9	5,5	4,2	1,2	5,3	115		
A 56/180 T	505805601	180	1 1/2"G	3x400V ~	294	0,60		6,42	6,42	6,41	6,4	6,4	6,4	6,1	4,8		5,3	115		
A 56/180 XT	505804671	180	2"G	3x400V ~	291	0,60		6,4	6,3	6,2	6,1	6	5,9	5,7	4,4		5,2	115		
A 80/180 M	505807001	180	1 1/2"G	1 x 230V ~	264	1,15		8,25	8	7,6	7,4	7,2	6,9	6,3	3,8		5,3	115		
A 80/180 XM	505806041	180	2"G	1 x 230V ~	260	1,17		8,25	8	7,6	7,4	7,2	6,9	6,3	3,8		5,3	115		
A 80/180 T	505807601	180	1 1/2"G	3x400V ~	271	0,57		8,2	7,9	7,6	7,3	7	6,8	6,1	3,7		5,3	115		
A 80/180 XT	505806671	180	2"G	3x400V ~	272	0,57		8,2	7,9	7,6	7,3	7	6,8	6,1	3,7		5,2	115		
A 110/180 M	505808001	180	1 1/2"G	1 x 230V ~	410	1,77		11,3	11	10,8	10,5	10	9,8	8,9	6,7		5,3	54		
A 110/180 XM	505809001	180	2"G	1 x 230V ~	410	1,77		11,3	11	10,8	10,5	10	9,8	9,2	7	1,7	5,3	54		
A 110/180 T	505808601	180	1 1/2"G	3x400V ~	403	0,90		11,3	11	10,8	10,5	10	9,8	8,9	6,6		5,2	54		
A 110/180 XT	505809601	180	2"G	3x400V ~	403	0,90		11,3	11	10,8	10,5	10	9,8	9,2	7	1,6	5,2	54		

**A - B - D**

WET ROTOR CIRCULATORS

**B SINGLE WITH FLANGES**

MODEL	CODE	CENTRE DISTANCE mm	PUMP COUPLINGS	ELECTRICAL DATA			HYDRAULIC DATA												WEIGHT KG	Q.TY x PALLET	
				VOLTAGE 50 Hz	P1 MAX W	In A	Q m <sup>3</sup> /h l/min	H (m)													
								0	0,6	1,2	1,8	2,4	3	4,2	7,2	12					
<b>B 50/250.40 M</b>	505812041	250	DN 40	1 x 230 V ~	195	0,95	5,7	5,6	5,4	5,3	5,1	4,8	4,2	2,6		9,1	42				
<b>B 50/250.40 T</b>	505812671	250	DN 40	3x400 V ~	201	0,50	5,9	5,85	5,8	5,6	5,5	5,2	4,6	2,9		9,3	42				
<b>B 56/250.40 M</b>	505814041	250	DN 40	1 x 230 V ~	294	1,32	6,35	6,3	6,2	6,18	6	5,9	5,5	4,2	1,2	9,3	42				
<b>B 56/250.40 T</b>	505814671	250	DN 40	3x400 V ~	291	0,60	6,4	6,3	6,2	6,1	6	5,9	5,7	4,4		9,2	42				
<b>B 80/250.40 M</b>	505816041	250	DN 40	1 x 230 V ~	260	1,17	8,25	8	7,6	7,4	7,2	6,9	6,3	3,8		9,3	42				
<b>B 80/250.40 T</b>	505816671	250	DN 40	3x400 V ~	272	0,57	8,2	7,9	7,6	7,3	7	6,8	6,1	3,7		9,3	42				
<b>B 110/250.40 M</b>	505818001	250	DN 40	1 x 230 V ~	410	1,77	11,3	11	10,8	10,5	10	9,8	9,2	7	1,7	9,2	42				
<b>B 110/250.40 T</b>	505818601	250	DN 40	3x400 V ~	403	0,90	11,3	11	10,8	10,5	10	9,8	9,2	7	1,6	9,3	42				

**D TWIN WITH FLANGES**

MODEL	CODE	CENTRE DISTANCE mm	PUMP COUPLINGS	ELECTRICAL DATA			HYDRAULIC DATA												WEIGHT KG	Q.TY x PALLET	
				VOLTAGE 50 Hz	P1 MAX W	In A	Q m <sup>3</sup> /h l/min	H (m)													
								0	0,6	1,2	1,8	2,4	3	4,2	7,2	12					
<b>D 50/250.40 M</b>	505822041	250	DN 40 - PN 10	1 x 230 V ~	195	0,95	5,7	5,6	5,4	5,3	5,1	4,8	4,2	2,6		15,3	24				
<b>D 50/250.40 T</b>	505822671	250	DN 40 - PN 10	3x400 V ~	201	0,50	5,9	5,85	5,8	5,6	5,5	5,2	4,6	2,9		15,8	24				
<b>D 56/250.40 M</b>	505824041	250	DN 40 - PN 10	1 x 230 V ~	294	1,32	6,35	6,3	6,2	6,18	6	5,9	5,5	4,2	1,2	15,8	24				
<b>D 56/250.40 T</b>	505824671	250	DN 40 - PN 10	3x400 V ~	291	0,60	5,9	5,85	5,8	5,6	5,5	5,2	4,6	2,9		15,4	24				
<b>D 80/250.40 M</b>	505826041	250	DN 40 - PN 10	1 x 230 V ~	260	1,17	8,25	8	7,6	7,4	7,2	6,9	6,3	3,8		15,8	24				
<b>D 80/250.40 T</b>	505826671	250	DN 40 - PN 10	3x400 V ~	272	0,57	8,2	7,9	7,6	7,3	7	6,8	6,1	3,7		15,8	24				
<b>D 110/250.40 M</b>	505828001	250	DN 40 - PN 10	1 x 230 V ~	410	1,77	11,3	11	10,8	10,5	10	9,8	9,2	7	1,7	16	24				
<b>D 110/250.40 T</b>	505828601	250	DN 40 - PN 10	3x400 V ~	403	0,90	11,3	11	10,8	10,5	10	9,8	9,2	7	1,6	15,8	24				

# BPH - BMH - DPH - DMH

WET ROTOR CIRCULATORS



Pump for circulating hot water in small closed and pressurised or open tank civil and industrial community heating systems. Cast iron body and wet rotor motor. Die-cast aluminium motor casing. Flanged inlet and delivery mouths, fitted with threaded unions for pressure gauges. Technopolymer impeller, tempered stainless steel driving shaft. Stainless steel protective rotor sleeve and stator sleeve. Four pole asynchronous motor for the BMH and DMH versions, two pole motor for the BPH and DPH versions. The Single-phase circulator has been designed to work at three speeds - 230V, while the Three-phase circulator has been designed to work at two speeds - 230V and at three speeds - 400V. Thermal overload protection incorporated in the single-phase version. For the three-phase version the motor must be connected to the power supply through an external contactor. An automatic clapet type valve is incorporated into the delivery mouth of the twin version in order to prevent water from recirculating while the unit is not working; a blank flange is also supplied standard if one of the two motors must be serviced.

**Protection level**

IP 44 three-phase - IP42 single-phase

**Operating range**

from 1.5 to 78 m<sup>3</sup>/h with head up to 18 metres.

**Liquid temperature range** for three-phase version: from -10°C to +120°C (for the models BPH-DPH 150/340.65 T and BPH-DPH 150/360.80 T; BPH-DPH 150-180/280.50 T; BPH-DPH 180/340.65 T; BPH-DPH 180/360.80 T: from -10°C to +110°C). For single-phase version: from -10°C to +110°C.

**Characteristics of pumped liquid** clean, free from solids and mineral oils, non viscous, chemically neutral, close to the characteristics of water (max. glycol 30%).

**Maximum operating pressure** 10 bar (1000 kPa).

**Standard flanging** DN 40, DN 50, DN 65, DN 80 in PN 6/PN 10 (4 holes)

**Flanging on request** DN 80 in PN 10/PN 16 (8 holes)

**Installation** with MOTOR AXIS HORIZONTAL

**Cable grommet** PG 11

Only for extra EU markets. Please contact our sales network for more information



ACCESSORIES  
PAG. 79

**SINGLE WITH FLANGES**

BMH 1400 1/min.  
BPH 2800 1/min.

MODEL	CODE	CENTRE DISTANCE mm	PUMP COUPLINGS	ELECTRICAL DATA			HYDRAULIC DATA																WEIGHT KG	Q.TY x PALLET	
				VOLTAGE 50 Hz	P1 MAX W	In A	Q m <sup>3</sup> /h	0	1,8	2,4	3	4,2	5,4	7,2	9,6	12	14,4	18	24	30	36	42			54
BMH 30/250.40T	505900622	250	DN 40	3 x 230 V ~ 3 x 400 V ~	100 192	0,48 0,78	3,3	3,1	2,95	2,85	2,5	2,1	1,15											17,5	24
BPH 60/250.40M	505904002	250	DN 40	1 x 230 V ~	316	1,43	7,2	6,8	6,7	6,5	6,2	5,8	5	3,7	2									17,5	24
BPH 60/250.40T	505904622	250	DN 40	3 x 230 V ~ 3 x 400 V ~	253 348	0,81 0,99	7,65	7,4	7,3	7,2	6,8	6,4	5,45	3,9	2,25									17,5	24
BPH 120/250.40M	505907002	250	DN 40	1 x 230 V ~	510	2,24	11	10,3	10,1	9,8	9,2	8,6	7,65	6,2	4,35	2,4								17,5	24
BPH 120/250.40T	505907622	250	DN 40	3 x 230 V ~ 3 x 400 V ~	395 5,36	1,2 1,16	12		11	10,7	10,1	9,5	8,4	6,8	4,7	2,2								17,5	24
BMH 30/280.50T	505920622	280	DN 50	3 x 230 V ~ 3 x 400 V ~	148 255	0,7 1,12	3,15		3,02	3	2,93	2,85	2,65	2,3	1,75	1,2								24	24
BMH 60/280.50T	505923622	280	DN 50	3 x 230 V ~ 3 x 400 V ~	272 410	0,94 1,2	5,83		5,65	5,6	5,49	5,35	5,1	4,75	4,2	3,65	2,62							24	24
BPH 60/280.50M	505924002	280	DN 50	1 x 230 V ~	595	2,79	7,65	7,5	7,45	7,4	7,3	7,2	6,98	6,7	6,2	5,75	4,6	2,3						24	24
BPH 60/280.50T	505924622	280	DN 50	3 x 230 V ~ 3 x 400 V ~	464 589	1,35 1,31	7,95		7,75	7,7	7,6	7,5	7,35	6,92	6,45	5,85	4,65	2,4						24	24
BPH 120/280.50M	505927002	280	DN 50	1 x 230 V ~	870	3,97	11,3				10,8	10,5	10,3	9,9	9,4	8,5	7,2	4,8	2,1					24	24
BPH 120/280.50T	505927622	280	DN 50	3 x 230 V ~ 3 x 400 V ~	683 898	1,95 1,67	11,7				11,3	11	10,75	10,25	9,6	8,9	7,75	5,4	2,6					26	24
BPH 150/280.50T	505928622	280	DN 50	3 x 230 V ~ 3 x 400 V ~	1130 1470	3,22 2,9	15				14,6	14,4	14	13,6	12,7	11,8	10,5	7,5						26	24
BPH 180/280.50T	505929622	280	DN 50	3 x 230 V ~ 3 x 400 V ~	1230 1630	3,5 3	18,4						17,4	17	16,4	15,6	14,4	12	8,8	5,2				26	24
BMH 30/340.65T	505940622	340	DN 65	3 x 230 V ~ 3 x 400 V ~	170 270	0,73 1,12	3,15				3,09	3,02	2,98	2,85	2,55	2,25	1,65							27,5	12
BMH 60/340.65T	505943622	340	DN 65	3 x 230 V ~ 3 x 400 V ~	295 445	1 1,2	5,4				5,15	5,05	4,9	4,7	4,45	4,1	3,45	2,25						27,5	12
BPH 60/340.65M	505944002	340	DN 65	1 x 230 V ~	735	3,37	6,8	6,79	6,75	6,7	6,6	6,57	6,5	6,35	6,2	5,95	5,5	4,35	2,85	1,2				27,5	12
BPH 60/340.65T	505944622	340	DN 65	3 x 230 V ~ 3 x 400 V ~	582 756	1,67 1,5	7,4				7,35	7,3	7,24	7,1	6,9	6,65	6,15	4,9	3,3	1,4				30,5	12
BPH 120/340.65T	505947622	340	DN 65	3 x 230 V ~ 3 x 400 V ~	1001 1275	2,85 2,64	10,9				10,75	10,68	10,6	10,5	10,38	10,2	9,8	8,7	7,15	5,2	3			32,5	12
BPH 150/340.65T	505948622	340	DN 65	3 x 230 V ~ 3 x 400 V ~	1345 1796	3,8 3,25	14,9				14,88	14,83	14,75	14,65	14,55	14,3	13,88	12,65	11	9,35	7,15			32,5	12
BPH 180/340.65T	505949622	340	DN 65	3 x 230 V ~ 3 x 400 V ~	1730 2760	4,85 4,2	17,9						17,8	17,7	17,5	17,3	16,8	15,7	14,1	12,1	10			32,5	12
BMH 30/360.80T	505960122	360	DN 80	3 x 230 V ~ 3 x 400 V ~	313 484	1,05 1,23	3,9						3,85	3,8	3,75	3,65	3,48	3,1	2,45	1,75				31	12
BMH 60/360.80T	505963122	360	DN 80	3 x 230 V ~ 3 x 400 V ~	535 763	1,82 2,04	5,7						5,66	5,61	5,59	5,5	5,4	5	4,55	3,9	3,1			40	12
BPH 120/360.80T	505967122	360	DN 80	3 x 230 V ~ 3 x 400 V ~	1410 1820	3,95 3,3	11,8						11,65	11,58	11,5	11,4	11,25	10,75	10,2	9,39	8,37	5,65		40	12
BPH 150/360.80T*	505968122	360	DN 80	3 x 230 V ~ 3 x 400 V ~	1984 2870	5,62 4,64	15,3						15,1	15,06	14,99	14,92	14,75	14,5	14	13,4	12,4	10,3	6	40	12
BPH 180/360.80T	505969122	360	DN 80	3 x 230 V ~ 3 x 400 V ~	1670 2310	4,7 4	17,5						17,4	17,25	17,1	16,8	16,25	15	13,7	12	10,1	5,5		40	12

\* model available for all markets





# EVOPLUS SMALL SAN

ELECTRONIC CIRCULATORS FOR HEATING AND AIR-CONDITIONING SYSTEMS



Circulator for domestic hot water systems of the closed circuit pressurized type or open circuit type. Bronze pump body. Motor casing in die-cast aluminium. Technopolymer impeller. Ceramic motor shaft mounted on graphite bushings lubricated by the pumped liquid. Stainless steel rotor sleeve, stator sleeve and closing flange. Ceramic thrust ring, ethylene propylene sealing rings. Synchronous motor with permanent magnet rotor.

### Operating range

from 2 to 12 m<sup>3</sup>/h with head up to 11 meters.

### Liquid temperature range

from -10 °C to 110 °C.

**Pumped liquid** clean, free from solids and mineral oils, not viscous, chemically neutral, close to the properties of water.

### Maximum working pressure

16 bar (1600 kPa).

### Protection rating

IP 44.

### Insulation class

F.

**Installation** with horizontal motor shaft.

# evoplus<sup>+</sup>



PAG. 5

ACCESSORIES  
PAG. 79

## SINGLE UNIONS

MODEL	CODE	CENTRE DISTANCE mm	PUMP COUPLINGS	UNIONS ON REQUEST		ELECTRICAL DATA			HYDRAULIC DATA							WEIGHT Kg	
				STANDARDISED	SPECIAL	VOLTAGE 50/60 Hz	P1 MAX W	In A	Q m <sup>3</sup> /h l/min	0 0	2,4 40	3 50	4,2 70	5,4 90	7,2 120		9,6 160
EVOPLUS 40/180 SAN M	60151144	180	1" ½	1" F	1/2" F - 3/4" F - UNION KIT TO BE WELDED Ø 22 / Ø 28	220/240 V	70	0,52	H (m)	4,2	4,2	4	3,1	2,4			4,5
EVOPLUS 60/180 SAN M	60151145	180	1" ½	1" F	1/2" F - 3/4" F - UNION KIT TO BE WELDED Ø 22 / Ø 28	220/240 V	100	0,72		6,1	6,1	5,8	4,6	3,4			4,5
EVOPLUS 80/180 SAN M	60151146	180	1" ½	1" F	1/2" F - 3/4" F - UNION KIT TO BE WELDED Ø 22 / Ø 28	220/240 V	135	0,95		8,2	8,2	7,7	6,2	4,8	2,9		4,5
EVOPLUS 110/180 SAN M	60151147	180	1" ½	1" F	1/2" F - 3/4" F - UNION KIT TO BE WELDED Ø 22 / Ø 28	220/240 V	170	1,16		11,1	10,1	9,2	7,5	5,9	3,9		4,5

## SINGLE WITH FLANGES

MODEL	CODE	CENTRE DISTANCE mm	UNIONS ON REQUEST	ELECTRICAL DATA			HYDRAULIC DATA							WEIGHT Kg		
				VOLTAGE 50/60 Hz	P1 MAX W	In A	Q m <sup>3</sup> /h l/min	0 0	2,4 40	3 50	4,2 70	5,4 90	7,2 120		9,6 160	
DN 32	EVOPLUS B 40/220.32 SAN M	60151148	DN 32 PN 6	220/240 V	85	0,55	H (m)	4,2	4,2	4,2	3,3	2,5	1,3			8,6
	EVOPLUS B 60/220.32 SAN M	60151151	DN 32 PN 6	220/240 V	110	0,75		6,1	6,1	5,6	4,6	3,6	2,2			8,6
	EVOPLUS B 80/220.32 SAN M	60151152	DN 32 PN 6	220/240 V	150	0,97		8	8	7,3	6	4,9	3,3			8,6
	EVOPLUS B 110/220.32 SAN M	60151153	DN 32 PN 6	220/240 V	200	1,3		11,2	10,5	9,6	8,1	6,8	5	2,6		8,6
DN 40	EVOPLUS B 40/250.40 SAN M	60151154	DN 40 PN 10	220/240 V	75	0,55	H (m)	4,2	4,2	4,2	3,3	2,5	1,3			9,3
	EVOPLUS B 60/250.40 SAN M	60151155	DN 40 PN 10	220/240 V	105	0,75		6,1	6,1	5,6	4,6	3,6	2,2			9,3
	EVOPLUS B 80/250.40 SAN M	60151157	DN 40 PN 10	220/240 V	140	0,97		8	8	7,3	6	4,9	3,3			9,3
	EVOPLUS B 110/250.40 SAN M	60151158	DN 40 PN 10	220/240 V	190	1,3		11,2	10,5	9,6	8,1	6,8	5	2,6		9,3

# EVOPLUS SAN

ELECTRONIC CIRCULATORS FOR HEATING AND AIR-CONDITIONING SYSTEMS



Circulator for domestic hot water systems of the closed circuit pressurized type or open circuit type. Bronze pump body. Motor casing in die-cast aluminium. Technopolymer impeller. Steel motor shaft mounted on ceramic bushings lubricated by the pumped liquid. Stainless steel rotor sleeve and closing flange, stator sleeve in carbon fibre composite. Ceramic thrust ring, ethylene propylene sealing rings. Synchronous motor with permanent magnet rotor.

### Operating range

from 4 to 42 m<sup>3</sup>/h with head up to 17 meters.

### Liquid temperature range

from -10 °C to 110 °C.

**Pumped liquid** clean, free from solids and mineral oils, not viscous, chemically neutral, close to the properties of water.

**Maximum working pressure** 16 bar (1600 kPa).

**Protection rating** IP 44.

**Insulation class** F.

**Installation** with horizontal motor shaft.

# evoplus<sup>+</sup>



**D+CONNECT**

PAG. 5

ACCESSORIES  
PAG. 79

## SINGLE WITH FLANGES

MODEL	CODE	CENTRE DISTANCE mm	COUNTERFL. ON REQUEST	ELECTRICAL DATA			HYDRAULIC DATA													WEIGHT KG								
				VOLTAGE 50/60 Hz	P1 MAX W	In A	Q m <sup>3</sup> /h l/min	0	4,2	5,4	7,2	9,6	12	14,4	18	24	30	36	42									
<b>DN 32</b> EVOPLUS B 120/220.32 SAN M	60151163	220	DN 32 PN 6	220/240 V	340	1,7	H (m)	12,1	11,5	10,7	9,5	7,9	6,3	4,7	2,2											24		
<b>DN 40</b> EVOPLUS B 120/250.40 SAN M	60151164	250	DN 40 PN 10	220/240 V	465	2,2	H (m)	12			11,5	10,1	8,7	7,3	5,2												22	
EVOPLUS B 150/250.40 SAN M	60151165	250	DN 40 PN 10	220/240 V	610	2,9		15				14,5	12,8	11,3	9,7	7,5	3,8											20
EVOPLUS B 180/250.40 SAN M	60151166	250	DN 40 PN 10	220/240 V	610	2,9		18		16,2	14,6	13	11,2	9,6	7,4	3,9												20
<b>DN 50</b> EVOPLUS B 100/280.50 SAN M	60151167	280	DN 50 PN 10	220/240 V	430	2,1	H (m)	10			9,4	8,4	7,5	6,7	5,5	3,6	2										22	
EVOPLUS B 120/280.50 SAN M	60151169	280	DN 50 PN 10	220/240 V	530	2,5		12				11	9,9	9	8,2	6,9	4,8	3									21,8	
EVOPLUS B 150/280.50 SAN M	60151170	280	DN 50 PN 10	220/240 V	640	3		15,3			12,4	11,5	10,6	9,6	8,3	6,2	4,2										22,8	
EVOPLUS B 180/280.50 SAN M	60151171	280	DN 50 PN 10	220/240 V	750	3,45		17,1			14	13	12	11,1	9,7	7,4	5,2	3,1									22,8	
<b>DN 65</b> EVOPLUS B 40/340.65 SAN M	60151172	340	DN 65 PN 10	220/240 V	190	1,1	H (m)	4			4	3,8	3,4	3	2,4	1,4										27		
EVOPLUS B 60/340.65 SAN M	60151173	340	DN 65 PN 10	220/240 V	355	1,8		6				6	5,9	5,4	4,7	3,7	2,2									27,2		
EVOPLUS B 80/340.65 SAN M	60151176	340	DN 65 PN 10	220/240 V	465	2,2		8				7,8	7,4	6,8	5,9	4,6	3,5	2								27,8		
EVOPLUS B 100/340.65 SAN M	60151177	340	DN 65 PN 10	220/240 V	590	2,8		10,1				9,8	9,1	8,4	7,6	6,1	4,7	3,1								28		
EVOPLUS B 120/340.65 SAN M	60151178	340	DN 65 PN 10	220/240 V	730	3,45		12				11,5	10,8	10	9	7,4	5,9	4,6	2,8							28,2		
EVOPLUS B 150/340.65 SAN M	60151179	340	DN 65 PN 10	220/240 V	1210	5,5		15,2					14,9	14,7	14	12,1	10,3	8,5	6,9							30		

## VS

### WET ROTOR CIRCULATORS



Pump for hot water circulation in hot water domestic systems of the closed and pressurised or open tank type. Also suitable for solar power systems.

Single body formed of the bronze hydraulic unit. Die-cast aluminium motor casing. Technopolymer impeller. Alumina driving shaft mounted on graphite brushings lubricated by the pumped liquid itself. Stainless steel protective rotor sleeve, stator sleeve and closing flange. Ceramic thrust bearing, E.P.D.M. "O" rings. The two-pole or four-pole asynchronous motor with wet rotor is self-protected for resistance. **No overload protection required.**

#### Operating range

from 0.5 to 3,6 m<sup>3</sup>/h with head up to 6 metres.

#### Liquid temperature range

from -10°C to +85°C (for sanitary use)  
+110°C (for others use).

**Pumped liquid characteristics** clean, free from solids and mineral oils, non viscous, chemically neutral, close to the characteristics of water (max 30% glycol).

#### Maximum working pressure

10 bar (1000 kPa).

#### Protection level

IP 44

#### Insulation class

F

#### Cable grommet

PG 11

#### Installation

with motor axis horizontal.

ACCESSORIES  
PAG. 79

MODEL	CODE	CENTRE DISTANCE mm	PUMP COUPLINGS	UNIONS ON REQUEST	ELECTRICAL DATA			ENERGY CLASS	HYDRAULIC DATA						WEIGHT KG	Q.TY x PALLET	
					VOLTAGE 50 Hz	P1 MAX W	In A		Q=m <sup>3</sup> /h	0	0,6	1,2	1,8	2,4			3
VS 8/150 M	60182217	150	1 1/2"	Brass 1/2" F - 3/4" F - 1" F Copper d22 e d28	1x230V	22	0,14	B	H (m)	0,83	0,75	0,52	0,22			2,6	180
VS 16/150 M	60182216	150	1 1/2"	Brass 1/2" F - 3/4" F - 1" F Copper d22 e d28	1x230V	41	0,19	B		1,82	1,75	1,65	1,44	1,07	0,6	2,6	180
VS 35/150 M	60182215	150	1 1/2"	Brass 1/2" F - 3/4" F - 1" F Copper d22 e d28	1x230V	55	0,24	B		4,1	3,7	3,3	2,82	2,2	1,3	2,6	180
VS 65/150 M	60182213	150	1 1/2"	Brass 1/2" F - 3/4" F - 1" F Copper d22 e d28	1x230V	78	0,34	C		6	5,55	5,05	4,25	3,4	2,6	2,6	180

COMMAND AND  
CONTROL SYSTEMS

CIRCULATORS AND  
IN-LINE PUMPS

MULTISTAGE CENTRIFUGAL  
AND SELF-PRIMING PUMPS

SWIMMING POOL, POND AND  
SALT WATER PUMPS

BQ

## ALME / ALPE

### ELECTRONIC IN-LINE PUMPS



Circulator for hot or cold water with in-line ports, suitable for installation directly on the pipes in civil and industrial heating air conditioning, refrigeration, and domestic water systems. Extremely versatile thanks to the use of the **MCE/C** inverter, the circulator performance is such as to allow automatic adaptation to meet the various requirements of the system, while keeping pressure differentials unchanged.

Pump body and motor support in cast iron.  
2" M-GAS inlet and outlet. Impeller in technopolymer, carbon/ceramic mechanical seal.

Four-pole totally enclosed asynchronous motor with external cooling for version **ALME** and two pole motor for version **ALPE**. Rotor mounted on oversized greased sealed-for-life ball bearings to ensure silent running and long life. Constructed following the CEI 2-3 standards.

#### Operating range

from 1 to 8.4 m<sup>3</sup>/h with head up to 21 metres.

#### Liquid temperature range

From -15 °C to +120°C.

**Liquid quality requirements** clean, free from solid or abrasive substances, not viscous, not aggressive, not crystallised and chemically neutral, characteristics similar to water – maximum glycol percentage 30 % (for different glycol percentages, please contact the Technical Assistance Service).

#### Installation

fixed horizontally.

#### Maximum ambient temperature

+40°C

#### Maximum working pressure

10 bar (1000 kPa)

#### Protection rating

IP 55

#### Insulation class

F

D+CONNECT

PAG. 5

MCE/C  
PAG. 22

ACCESSORIES  
PAG. 79

MODEL	CODE	ELECTRICAL DATA			HYDRAULIC DATA											DNA GAS	DNM GAS	WEIGHT KG			
		VOLTAGE 50/60 Hz	P2 NOMINAL		In A	Q=m <sup>3</sup> /h	0	1,2	2,4	3,6	4,8	6	7,2	8,4	Q=l/min				0	20	40
ALME 500 M MCE11/C	60143227	1x230V	0,25	0,33	3,2	H (m)	5,5	5,4	5,3	4,8	4,1	3	1,5		2" M	2" M	19,5				
ALPE 2000 M MCE11/C	60143228	1x230V	0,55	0,75	6,4		21,1	20,6	19,6	18	16	13,8	10,5	5,3	2" M	2" M	19,5				

CENTRIFUGAL PUMPS

SUBMERSIBLE PUMPS

SUBMERSIBLE PUMPS  
AND SUBMERSIBLE MOTORS

PRESSURE UNITS



# ELECTRONIC IN-LINE PUMPS

PERFORMANCE RANGE

## KLME/ KLPE - HEATING, AIR CONDITIONING, SOLAR PANEL AND HOT WATER SYSTEM

MODELLO	P2 NOMINALE		Q (m³/h) (l/min)	0	2,4	3,6	4,8	6	7,2	8,4	9,6	12	14,4	16,8	18	24	30	36	48	60	72	84		
	kW	HP		0	40	60	80	100	120	140	160	200	240	280	300	400	500	600	800	1000	1200	1400		
KLPE 40- 600	0,37	0,5	H (m)	8,3	8,2	8	7,9	7,7	7,3	7	6,6	5,4	3,8	2										
KLPE 40-1200	0,55	0,75		13,9	13,4	13,2	13	12,6	12,2	11,8	11,3	9,9	8,2	6,2	5									
KLPE 40-1800	0,85	1,2		18,8	18,3	18	17,6	17,2	16,7	16,2	15,6	14,1	12,4	10,3	9	2,2								
KLME 50-600	0,25	0,33		5,8	5,8	5,7	5,6	5,5	5	5,2	5	4,5	4,0	3,2	2,8									
KLPE 50-1200	0,75	1		12,2	12,2	12,2	12,1	12,0	11,9	11,7	11,5	11,0	10,3	9,5	9,1	6,6	3,8							
KLPE 50-2000	1,83	2,5		23,4	23,3	23,3	23,2	23,2	23,1	22,9	22,8	22,4	21,8	21,0	20,6	18,2	15,2	12						
KLME 65-600	0,37	0,5		5,1	5,1	5,1	5,1	5,0	5,0	4,9	4,8	4,5	4,2	3,8	3,6	2,1								
KLPE 65-1200	1,1	1,5		12,3	12,3	12,3	12,3	12,3	12,2	12,2	12,2	12,2	12,1	12,0	12,0	11,0	9,2	6,8						
KLPE 65-2000	2	2,7		20,6	20,7	20,7	20,7	20,7	20,7	20,6	20,6	20,5	20,3	20,0	19,8	18,8	17,2	15,1	9,7					
KLME 80-600	0,75	1		5,6	5,7	5,7	5,8	5,8	5,8	5,8	5,8	5,8	5,8	5,7	5,7	5,4	5,0	4,3	2,4					
KLPE 80-1200	1,84	2,5		11,8	11,7	11,7	11,7	11,7	11,7	11,7	11,7	11,6	11,6	11,6	11,6	11,5	11,3	11,0	9,8	7,4	4,2			
KLPE 80-2000	3,67	5		20,8	20,9	20,9	21,0	21,0	21,0	21,0	21,0	21,1	21,1	21,1	21,1	21,1	21,0	20,6	19,3	17,4	14,8	11,7		

## DKLME / DKLPE- HEATING, AIR CONDITIONING, SOLAR PANEL AND HOT WATER SYSTEM

MODELLO	P2 NOMINALE		Q (m³/h) (l/min)	0	2,4	3,6	4,8	6	7,2	8,4	9,6	12	14,4	16,8	18	24	30	36	48	60	72			
	kW	HP		0	40	60	80	100	120	140	160	200	240	280	300	400	500	600	800	1000	1200			
DKLPE 40- 600	0,37	0,5	H (m)	8,3	8,0	7,8	7,5	7,1	6,6	6,0	5,4	3,9	1,9											
DKLPE 40-1200	0,55	0,75		14,3	13,9	13,6	13,2	12,8	12,3	11,8	11,1	9,4	7,5	5,3	4,1									
DKLPE 40-1800	0,85	1,2		19,1	18,6	18,2	17,8	17,3	16,7	16,1	15,4	13,6	11,5	9,1	7,7									
DKLME 50-600	0,25	0,33		5,7	5,5	5,4	5,3	5,1	4,9	4,6	4,2	3,6	2,9	2,0	1,6									
DKLPE 50-1200	0,75	1		12,3	12,0	11,9	11,7	11,5	11,3	11,0	10,8	10,1	9,3	8,4	7,9	5,0								
DKLPE 50-2000	1,83	2,5		23,2	23,0	22,8	22,6	22,3	22,0	21,6	21,3	20,4	19,5	18,5	17,9	14,8	11,2	7,0						
DKLME 65-600	0,37	0,5		5,1	5,1	5,1	5,0	5,0	4,8	4,7	4,5	4,2	3,8	3,3	3,1	1,7								
DKLPE 65-1200	1,1	1,5		12,4	12,3	12,3	12,2	12,1	12,1	12,0	12,0	11,9	11,7	11,5	11,4	10,2	8,3	6,0						
DKLPE 65-2000	2	2,7		20,4	20,2	20,1	20,0	20,0	20,0	19,9	19,8	19,7	19,4	19,1	19,0	17,5	15,5	13,0	7,8					
DKLME 80-600	0,75	1		5,6	5,6	5,6	5,6	5,6	5,6	5,5	5,5	5,4	5,3	5,2	5,0	4,6	3,9	3,1						
DKLPE 80-1200	1,84	2,5		11,9	11,8	11,8	11,8	11,7	11,7	11,6	11,6	11,5	11,3	11,2	11,1	10,5	9,7	8,8	4,5	3,9				
DKLPE 80-2000	3,67	5		20,3	20,3	20,3	20,3	20,3	20,3	20,3	20,3	20,3	20,2	20,2	20,1	19,9	19,4	18,8	16,8	13,9	10,4			

# KLME / KLPE / DKLME / DKLPE

ELECTRONIC IN-LINE PUMPS



Circulator for hot or cold water with in-line ports, suitable for installation directly on the pipes in civil and industrial heating air conditioning, refrigeration, and domestic water systems. Extremely versatile thanks to the use of the **MCE/C** inverter, the circulator performance is such as to allow automatic adaptation to meet the various requirements of the system, while keeping pressure differentials unchanged. Pump body and motor support in cast iron. PN 10 Flanged inlet and delivery mouths, fitted with threaded holes for pressure gauges. To facilitate interchangeability in existing installations, the pump is designed to accept PN 6 counterflanges. Impeller in technopolymer. Carbon/ceramic mechanical seal. The pumps are available both in the single version (**KLME-KLPE**) and in the twin version (**DKLME-DKLPE**). An automatic clapet type valve is incorporated into the delivery mouth of the twin version in order to prevent water from recirculating while the unit is not working. In addition, a set of blank flanges is supplied for use when maintenance of one of the two motors is necessary. The twin version makes it possible to alternate operation of the pumps when the back-up unit is requested, or simultaneous operation of the two pumps. Four-pole totally enclosed asynchronous motor with fan-over cooling for versions **KLME** and **DKLME** and two pole motor for versions **KLPE** and **DKLPE**. Rotor mounted on oversized greased sealed-for-life ball bearings to ensure silent running and long life. Integral thermal and current overload protection. Constructed following the CEI 2-3 standards.

## Operating range

from 2 to 84 m<sup>3</sup>/h with head up to 23,4 meters.

## Liquid temperature range

From -15 °C to +120°C.

**Liquid quality requirements** clean, free from solid or abrasive substances, not viscous, not aggressive, not crystallised and chemically neutral, characteristics similar to water - maximum glycol percentage 30 % (for different glycol percentages, please contact the Technical Assistance Service).

**Installation** normally horizontal or vertical provided the motor is always above the pump.

**Maximum ambient temperature** +40°C

**Maximum working pressure** 10 bar (1000 kPa)

**Protection rating** IP 55

**Insulation class** F

**Standard flanging** DN 40, DN 50, DN 65, DN 80 in PN 6/PN 10 (4 Holes)



PAG. 5

MCE/C  
PAG. 22

ACCESSORIES  
PAG. 79

## KLME/KLPE SINGLE FLANGES WITH INVERTER MCE/C

MODEL	FLANGE DIMENS. (mm)		POLES	VOLTAGE 50/60 Hz - 1x220-240 ~ V					VOLTAGE 50 Hz - 3x400 ~ V						
	DNA	DNM		MODEL MCE	P2 NOMINAL		In A	WEIGHT (Kg)	CODE	MODEL MCE	P2 NOMINAL		In A	WEIGHT (Kg)	
					kW	HP					kW	HP			
KLPE 40-600	40	40	2	60142750 *	MCE11/C	0,37	0,50	4,3	26						
KLPE 40-1200	40	40	2	60142224 *	MCE11/C	0,55	0,75	6,0	26						
KLPE 40-1800	40	40	2	60178953 *	MCE11/C	0,85	1,2	5,8	28						
KLME 50-600	50	50	4	60142751 *	MCE11/C	0,25	0,33	4,1	31						
KLPE 50-1200	50	50	2	60141862 *	MCE11/C	0,75	1,00	7,7	33						
KLPE 50-2000	50	50	2	60180793 *	MCE15/C	1,83	2,5	12,8	41						
KLME 65-600	65	65	4	60143475 *	MCE11/C	0,37	0,50	4,3	37						
KLPE 65-1200	65	65	2	60141861 *	MCE11/C	1,10	1,50	11	43	60144828 *	MCE30/C	1,10	1,50	3,9	58
KLPE 65-2000	65	65	2	60180040 *	MCE22/C	2	2,7	13,1	47	60179929 *	MCE30/C	2	2,7	5,3	51
KLME 80-600	80	80	4	60142752 *	MCE11/C	0,75	1,00	7,0	47						
KLPE 80-1200	80	80	2	60142212 *	MCE15/C	1,84	2,50	16,7	47	60146306 *	MCE30/C	1,84	2,50	4,8	52
KLPE 80-2000	80	80	2							60181004 *	MCE55/C	3,67	5	9,1	60

\*Available with proportional differential pressure regulation ΔP-v

## DKLME/DKLPE TWIN FLANGES WITH INVERTER MCE/C

MODEL	FLANGE DIMENS. (mm)		POLES	VOLTAGE 50/60 Hz - 1x220-240 ~ V					VOLTAGE 50 Hz - 3x400 ~ V						
	DNA	DNM		MODEL MCE	P2 NOMINAL		In A	WEIGHT (Kg)	CODE	MODEL MCE	P2 NOMINAL		In A	WEIGHT (Kg)	
					kW	HP					kW	HP			
DKLPE 40-600	40	40	2	60142753 *	MCE11/C	0,37	0,50	4,3	56						
DKLPE 40-1200	40	40	2	60141905 *	MCE11/C	0,55	0,75	6,0	61						
DKLPE 40-1800	40	40	2	60179347 *	MCE11/C	0,85	1,2	5,8	66						
DKLME 50-600	50	50	4	60142759 *	MCE11/C	0,25	0,33	4,1	76						
DKLPE 50-1200	50	50	2	60142258 *	MCE11/C	0,75	1,00	7,7	88						
DKLPE 50-2000	50	50	2	60181033 *	MCE15/C	1,83	2,5	12,8	104						
DKLME 65-600	65	65	4	60142761 *	MCE11/C	0,37	0,50	4,3	80						
DKLPE 65-1200	65	65	2	60141906 *	MCE11/C	1,10	1,50	11	99	60144099 *	MCE30/C	1,10	1,50	3,9	92
DKLPE 65-2000	65	65	2	60180200 *	MCE22/C	2	2,7	13,1	108	60179980 *	MCE30/C	2	2,7	5,3	116
DKLME 80-600	80	80	4	60142763 *	MCE11/C	0,75	1,00	7,0	96						
DKLPE 80-1200	80	80	2	60141907 *	MCE15/C	1,84	2,50	16	98	60146305 *	MCE30/C	1,84	2,50	4,8	108
DKLPE 80-2000	80	80	2							60181052 *	MCE55/C	3,67	5	9,1	125

\*Available with proportional differential pressure regulation ΔP-v

# ELECTRONIC IN-LINE PUMPS

PERFORMANCE RANGE

## CME /CM-GE - HEATING, AIR CONDITIONING, SOLAR PANEL AND HOT WATER SYSTEM

MODEL	P2 NOMINAL		Q (m³/h) (l/min)	H (m)																																					
	kW	HP		0	1,2	2,4	3	3,6	4,5	4,8	6	12	18	24	30	36	42	48	54	60	66	72	78	84	90	102	114	120	150	180	210	240	250	270	330	360					
CME 40- 870 M MCE11/C	0,7	1	8,7	8,7	8,6	8,6	8,5	8,3	8,3	8,2	5																														
CME 40-1450 M MCE11/C	0,9	1,3					14,5	14,4	14,3	11,8	8																														
CME 40-1450 T MCE30/C	0,9	1,3					14,5	14,4	14,3	11,8	8																														
CME 50-1000 M MCE11/C	0,7	1				10,1	10	9,8	9,6	6,8																															
CME 50-1420 M MCE11/C	1,1	1,5							14,2	13	10	6																													
CME 50-1420 T MCE30/C	1,1	1,5							14,2	13	10	6																													
CM-GE 65- 660/A/BAQE/0.55 M MCE11/C	0,55	0,75	6,6						6,5	6,2	5,7	4,8																													
CM-GE 65- 920/A/BAQE/0.75 M MCE11/C	0,75	1	9,2						9,2	9	8,4	7,4	5,7																												
CM-GE 65- 920/A/BAQE/0.75 T MCE30/C	0,75	1	9,2						9,2	9	8,4	7,4	5,7																												
CM-GE 65-1200/A/BAQE/1.5 M MCE11/C	1,5	2	12							12	11,9	11,5	10,8	10,1	8,9																										
CM-GE 65-1200/A/BAQE/1.5 T MCE30/C	1,5	2	12							12	11,9	11,5	10,8	10,1	8,9																										
CM-GE 65-1680/A/BAQE/3 T MCE30/C	3	4	16,8						16,8	16,5	16,1	15,5	14,6	13,6	12,4	10,9																									
CM-GE 65-2380/A/BAQE/4 T MCE55/C	4	5,5	23,8						24	23,8	23,4	22,7	21,6	20,4	19	17,1																									
CM-GE 80- 650/A/BAQE/0.75 M MCE11/C	0,75	1	6,5						6,3	6,1	5,8	5,5	5	4,5	3,9																										
CM-GE 80- 650/A/BAQE/0.75 T MCE30/C	0,75	1	6,5						6,3	6,1	5,8	5,5	5	4,5	3,9																										
CM-GE 80- 890/A/BAQE/1.5 M MCE11/C	1,5	2	8,9							8,8	8,7	8,6	8,3	8	7,6	7,2	6,6	6																							
CM-GE 80- 890/A/BAQE/1.5 T MCE30/C	1,5	2	8,9							8,8	8,7	8,6	8,3	8	7,6	7,2	6,6	6																							
CM-GE 80-1530/A/BAQE/3 T MCE30/C	3	4	15,3								15,4	15,3	15	14,6	14,1	13,5	12,9	12,2	11,3																						
CM-GE 80-1700/A/BAQE/4 T MCE55/C	4	5,5	17								17,2	17,2	17,1	16,8	16,5	16,2	15,7	15,1	14,3	13,6	12,6																				
CM-GE 80-2410/A/BAQE/5.5 T MCE55/C	5,5	7,5	24,1									23,8	23,6	23,3	22,8	22,3	21,5	20,8	19,7	18,6	17,3																				
CM-GE 80-2700/A/BAQE/7.5 T MCE110/C	7,5	10	27												26	25,5	25	24,5	23,6	22,7	21,5	20,2	19																		
CM-GE 80-3420/A/BAQE/11 T MCE110/C	11	15	34,2													33,2	33	32,5	32	31,5	30,7	29,8	29	28	25	21,7															
CM-GE 100- 510/A/BAQE/0.75 M MCE11/C	0,75	1	5,1							4,9	4,8	4,7	4,7	4,4	4,2	3,8	3,4	3																							
CM-GE 100- 510/A/BAQE/0.75 T MCE30/C	0,75	1	5,1							4,9	4,8	4,7	4,7	4,4	4,2	3,8	3,4	3																							
CM-GE 100- 865/A/BAQE/2,2 M MCE22/C	1,5	2	8,6												8,3	8,2	8,1	7,9	7,7	7,5	7,3	7,1	6,8	6,5	6,2	5,6	4,8														
CM-GE 100- 865/A/BAQE/2,2 T MCE30/C	1,5	2	8,6												8,3	8,2	8,1	7,9	7,7	7,5	7,3	7,1	6,8	6,5	6,2	5,6	4,8														
CM-GE 100-1020/A/BAQE/3 T MCE30/C	3	4	10,2												10,2	10,1	10	9,9	9,8	9,7	9,5	9,3	9	8,8	8,6	7,9	7,2	6,7													
CM-GE 100-1320/A/BAQE/4 T MCE30/C	4	5,5	13,2															13,2	13,2	13,1	12,9	12,7	12,4	12	11,7	11,3	10,4	9,3	8,7												
CM-GE 100-1650/A/BAQE/5,5 T MCE55/C	5,5	7,5	16,5															16,6	16,5	16,4	16,2	16,1	16	15,7	15,4	15	14,3	13,3	12,7												
CM-GE 100-2050/A/BAQE/7,5 T MCE110/C	7,5	10	20,5															21	21	21	20,7	20,5	20	19,8	19,5	19	18	16,7	16												
CM-GE 100-2550/A/BAQE/11 T MCE110/C	11	15	25,5															25,5	25,5	25,5	25,1	25	25	24,6	24,2	24	23	21,5	21												
CM-GE 100-3290/A/BAQE/15 T MCE150/C	15	20	32,9																33,1	33	32,9	32,8	32,4	32	31,6	30,5	29,5	28,9	24												
CM-GE 125-1075/A/BAQE/4 T MCE55/C	4	5,5	10,8																	10,1	10,1	10	9,9	9,7	9,5	9,1	8,5	8,3	7	5,4											
CM-GE 125-1270/A/BAQE/5,5 T MCE55/C	5,5	7,5	12,7																		12,6	12,6	12,5	12,5	12,4	12,3	12	11,5	11,4	10,1	8,5										
CM-GE 125-1560/A/BAQE/7,5 T MCE110/C	7,5	10	15,6																		15,4	15,4	15,3	15,2	15,1	15	14,7	14,5	14,3	13,3	11,6	9,8									
CM-GE 125-2100/A/BAQE/11 T MCE110/C	11	15	21																		21,5	21,5	21,5	21,4	21,2	21	20,9	20	19,8	18	16										
CM-GE 125-2550/A/BAQE/15 T MCE150/C	15	20	25,5																		25,5	25,5	25,5	25,3	25,1	25,1	25	24,5	24	22,5	20,5	17,5									
CM-GE 150- 955/A/BAQE/5,5 T MCE55/C	5,5	7,5	9,6																						9,6	9,5	9,4	9,3	8,7	7,8	6,7	5,9	5,5								
CM-GE 150-1322/A/BAQE/7,5 T MCE110/C	7,5	10	13,2																							13	12,8	12,6	12,5	11,9	11,1	10,1	8,9	8,5							
CM-GE 150-1600/A/BAQE/11 T MCE150/C	11	15	16																									15,5	15,5	15,4	14,8	14	13	11,8	11	10,5	9,2				
CM-GE 150-1950/A/BAQE/15 T MCE150/C	15	20	19,5																										19,5	19,4	19,3	19,2	18,7	17,8	16,8	16	15,5	14,1	12,5		



# ELECTRONIC IN-LINE PUMPS

PERFORMANCE RANGE

## DCME / DCM-GE - HEATING, AIR CONDITIONING, SOLAR PANEL AND HOT WATER SYSTEM

MODEL	P2 NOMINAL		Q (m³/h) (l/min)	H (m)																		
	KW	HP		0	3	4,5	6	12	18	24	30	36	42	48	54	60	66	72	78	84	90	102
DCME 40-620 M MCE11/C	0,3	0,3	6,3	6,2	6,0	5,8	3,0															
DCME 50-460 M MCE11/C	0,3	0,3	4,8			4,6	3,9	2,4														
DCME 50-880 M MCE11/C	0,5	0,7	9,1			8,8	7,7	5,9														
DCM-GE 65- 660/A/BAQE/0.55 M MCE11/C	0,55	0,75	6,5			6,4	5,9	4,4	3,1													
DCM-GE 65- 920/A/BAQE/0.75 M MCE11/C	0,75	1	9,1			9,1	8,8	7,4	5,8	3,5												
DCM-GE 65- 920/A/BAQE/0.75 T MCE30/C	0,75	1	9,1			9,1	8,8	7,8	6,4	4,5												
DCM-GE 65-1200/A/BAQE/1.5M MCE11/C	1,5	2	12,0				11,9	11,6	11,0	10,0	9,0	7,6										
DCM-GE 65-1200/A/BAQE/1.5 T MCE30/C	1,5	2	12,0				11,9	11,6	11,0	10,0	9,0	7,6										
DCM-GE 65-1680/A/BAQE/3 T MCE30/C	3	4	16,8				16,7	16,3	15,7	14,9	13,7	12,4	11,0	9,3								
DCM-GE 65-2380/A/BAQE/4 T MCE30/C	4	5,5	23,8				23,9	23,5	22,8	21,8	20,3	18,6	16,8	14,5								
DCM-GE 80- 650/A/BAQE/0.75 M IE2 MCE11/C	0,75	1	6,5				6,2	5,8	5,2	4,5	3,7	2,9	2,1									
DCM-GE 80- 650/A/BAQE/0.75 T MCE30/C	0,75	1	6,5				6,2	5,8	5,2	4,5	3,7	2,9	2,1									
DCM-GE 80- 890/A/BAQE/1.5 M MCE11/C	1,5	2	8,5						8,3	8,0	7,5	6,8	6,1	5,3	4,4	3,5						
DCM-GE 80- 890/A/BAQE/1.5 T MCE30/C	1,5	2	8,5						6,7	6,2	5,5	4,8	4,2	3,5	2,9	2,3						
DCM-GE 80-1530/A/BAQE/3T MCE30/C	3	4	14,4						14,1	13,7	13,0	12,2	11,3	10,2	9,2	8,0	6,8					
DCM-GE 80-1700/A/BAQE/4 T MCE55/C	4	5,5	16,0						15,7	15,5	15,3	14,6	14,0	13,2	12,3	11,2	10,0	8,9	7,7			
DCM-GE 80-2410/A/BAQE/5.5T MCE55/C	5,5	7,5	24,1								23,3	22,7	22,0	21,1	20,2	18,9	17,6	16,2				
DCM-GE 80-2700/A/BAQE/7.5 T MCE110/C	7,5	10	27,0								26,1	26,1	25,5	24,9	24,2	23,2	22,1	20,7	19,3	17,9		
DCM-GE 80-3420/A/BAQE/11 T MCE110/C	11	15	34,2								33,3	33,3	32,9	32,3	31,8	30,9	29,9	29,0	27,8	24,4	22,0	20,8
DCM-GE 100- 510/A/BAQE/0.75 M MCE11/C	0,75	1	4,9				4,8	4,7	4,6	4,5	4,0	3,7	3,2	2,6	2,1							
DCM-GE 100- 510/A/BAQE/0.75 T MCE30/C	0,75	1	4,9				4,8	4,7	4,6	4,5	4,0	3,7	3,2	2,6	2,1							

MODEL	P2 NOMINAL		Q (m³/h) (l/min)	H (m)																											
	KW	HP		0	30	36	42	48	54	60	66	72	78	84	90	102	114	120	150	180	210	240	250	270	330	360					
DCM-GE 100- 865/A/BAQE/1,5 M MCE22/C	1,5	2	8,6	8,4	8,3	8,1	7,9	7,6	7,4	7,1	6,8	6,4	6	5,6	4,7	3,5															
DCM-GE 100- 865/A/BAQE/1,5 T MCE30/C	1,5	2	8,6	8,4	8,3	8,1	7,9	7,6	7,4	7,1	6,8	6,4	6	5,6	4,7	3,5															
DCM-GE 100-1020/A/BAQE/3 T MCE30/C	3	4	10,2	10,2	10,0	9,8	9,6	9,5	9,3	8,9	8,5	8,0	7,5	7,1	5,9	4,7	4,0														
DCM-GE 100-1320/A/BAQE/4 T MCE55/C	4	5,5	13,2			13,2	13,1	13,0	12,8	12,4	11,9	11,3	10,8	10,2	8,8	7,4	6,6														
DCM-GE 100-1650/A/BAQE/5,5T MCE55/C	5,5	7,5	16,5			16,5	16,4	16,3	16,0	15,8	15,5	14,9	14,4	13,7	12,4	10,8	10,0														
DCM-GE 100-2050/A/BAQE/7,5 T MCE110/C	7,5	10	19,3					19,2	18,8	18,5	17,9	17,6	17,2	16,6	15,5	14,1	13,3														
DCM-GE 100-2550/A/BAQE/11 T MCE110/C	11	15	24,0					23,3	22,8	22,6	22,4	21,9	21,4	21,0	19,8	18,1	17,5														
DCM-GE 100-3290/A/BAQE/15 T MCE150/C	15	20	30,9					30,5	30,3	30,1	29,9	29,4	28,8	28,3	27,0	25,8	25,1	20,0													
DCM-GE 125-1075/A/BAQE/4 T MCE55/C	4	5,5	10,0					9,5	9,4	9,2	9,0	8,7	8,4	7,7	6,8	6,5	4,4	2,4													
DCM-GE 125-1270/A/BAQE/5.5 T MCE55/C	5,5	7,5	11,7					11,8	11,7	11,5	11,4	11,1	10,8	10,2	9,2	8,9	6,4	3,8													
DCM-GE 125-1560/A/BAQE/7.5 T MCE110/C	7,5	10	14,4					14,6	14,6	14,4	14,2	14,0	13,8	13,2	12,7	12,3	10,2	7,5	4,9												
DCM-GE 125-2100/A/BAQE/11 T MCE110/C	11	15	20,1									19,9	19,6	19,3	18,2	17,8	15,4	12,7													
DCM-GE 125-2550/A/BAQE/15 T MCE150/C	15	20	24,5									23,8	23,7	23,4	22,7	22,1	20,0	17,4	13,9												
DCM-GE 150- 955/A/BAQE/5.5 T IE2 MCE55/C	5,5	7,5	9,6													8,1	7,0	6,2	4,9	3,5	2,8										
DCM-GE 150-1322/A/BAQE/7.5T MCE110/C	7,5	10	11,8											11,5	11,5	11,4	11,0	10,0	8,5	7,2	6,0	5,5									
DCM-GE 150-1600/A/BAQE/11 T IE2 MCE110/C	11	15	14,8												14,2	14,2	14,0	13,4	12,5	11,4	10,1	9,4	8,8								
DCM-GE 150-1950/A/BAQE/15 T MCE150/C	15	20	18,1												17,9	17,8	17,7	17,5	16,9	15,9	14,8	14,0	13,5	10,5	8,9						

# CME / CM-GE / DCME / DCM-GE - 4 POLES

ELECTRONIC IN-LINE PUMPS



Circulation pumps with in-line ports, suitable for installation in heating and air conditioning, refrigeration, and domestic hot water systems. Extremely versatile thanks to the use of the **MCE/C** inverter, they offer performance capable of adapting automatically to the system's various demands while keeping pressure differentials unchanged. Available in single and twin version. PN 16 flanged inlet and delivery mouths, fitted with threaded holes for pressure gauges. Pump body and support in cast iron, impeller in cast iron or technopolymer depending on model (in bronze, on request, only from DN 65 to DN 150). Stainless steel drive shaft. Sealing device: standardised mechanical seal made to DIN 24960 in carbon / carborundum with O' rings in EPDM. 4-pole three-phase indication motor with external cooling. Rotor running on ball bearings, oversized to ensure low noise and durability. Constructed following the CEI 2-3 standards.

**Operating range** from 1.2 to 360 m<sup>3</sup>/h with head up to 34 meters.

**Liquid temperature range**  
from -10°C to + 130°C for DN 40 - 50  
from -10°C to + 140°C for rest of the range

**Liquid quality requirements** clean, free from solids or abrasive substances, non viscous, non aggressive, non crystallised and chemically neutral and close to the characteristics of water.

**Installation** Fixed, horizontal or vertical provided the motor is always above the pump.

**Maximum ambient temperature** +40°C

**Maximum working pressure** 16 bar

**Protection rating** IP 55

**Insulation Class** F

**Flanging** PN 16

**Counter-flanges on request**

DN 40 - DN 50 - DN 65 - DN 80 - DN 100 - DN 125 - DN 150; PN 16.



PAG. 5

MCE/C  
PAG. 22

ACCESSORIES  
PAG. 79

## CME/CM-GE SINGLE FLANGES WITH INVERTER MCE/C

MODEL	FLANGE DIMENS. (mm)		VOLTAGE 50/60 Hz - 1x220-240 ~ V					VOLTAGE 50 Hz - 3x400 ~ V						
	DNA	DNM	CODE	MODEL MCE	P2 NOMINAL		In A	WEIGHT (Kg)	CODE	MODEL MCE	P2 NOMINAL		In A	WEIGHT (Kg)
					kW	HP					kW	HP		
CME 40- 870	40	40	60142764 *	MCE11/C	0,75	1	10	45						
CME 40-1450	40	40	60142765 *	MCE11/C	0,9	1,2	10	35	60147374 *	MCE30/C	0,9	1,2	2,5	35
CME 50-1000	50	50	60142766 *	MCE11/C	0,75	1	5,6	51						
CME 50-1420	50	50	60142767 *	MCE11/C	1,1	1,5	11,3	40	60147375 *	MCE30/C	1,1	1,5	2,5	42,6
CM-GE 65-660	65	65	60142768 *	MCE11/C	0,55	0,8	7,3	62						
CM-GE 65-920	65	65	60191977 *	MCE11/C	0,75	1	9,8	64	60191994 *	MCE30/C	0,75	1	1,8	64
CM-GE 65-1200	65	65	60191978 *	MCE15/C	1,5	2	13,9	91	60191995 *	MCE30/C	1,5	2	3,6	91
CM-GE 65-1680	65	65							60191979 *	MCE30/C	3	4	6,8	101
CM-GE 65-2380	65	65							60191980 *	MCE55/C	4	5,5	8,2	115
CM-GE 80- 650	80	80	60191981 *	MCE11/C	0,75	1	9,8	67	60191996	MCE30/C	0,75	1	1,8	69,6
CM-GE 80- 890	80	80	60191982 *	MCE11/C	1,5	2	13,9	98	60191997 *	MCE30/C	1,5	2	3,6	98
CM-GE 80-1530	80	80							60191983 *	MCE30/C	3	4	6,8	134
CM-GE 80-1700	80	80							60191984 *	MCE55/C	4	5,5	8,2	147
CM-GE 80-2410	80	80							60191985 *	MCE55/C	5,5	7,5	10,6	175
CM-GE 80-2700	80	80							60167282	MCE110/C	7,5	10	14,4	205
CM-GE 80-3420	80	80							60167283 *	MCE110/C	11	15	22,4	222
CM-GE 100- 510	100	100	60191986 *	MCE11/C	0,75	1	9,7	104	60191998	MCE30/C	0,75	1	1,8	106,6
CM-GE 100- 865	100	100	60191987 *	MCE22/C	2,2	3	20,7	123	60191999	MCE30/C	2,2	3	5,9	126 n
CM-GE 100-1020	100	100							60191988 *	MCE30/C	3	4	6,8	118
CM-GE 100-1320	100	100							60191989 *	MCE30/C	4	5,5	8,2	150
CM-GE 100-1650	100	100							60191990 *	MCE55/C	5,5	7,5	10,6	172
CM-GE 100-2050	100	100							60167284	MCE110/C	7,5	10	14,4	252
CM-GE 100-2550	100	100							60167285 *	MCE110/C	11	15	22,4	255
CM-GE 100-3290	100	100							60167286 *	MCE150/C	15	20	30,5	350
CM-GE 125-1075	125	125							60191991 *	MCE55/C	4	5,5	8,2	207
CM-GE 125-1270	125	125							60191992 *	MCE55/C	5,5	7,5	10,6	209
CM-GE 125-1560	125	125							60167287 *	MCE110/C	7,5	10	14,4	228
CM-GE 125-2100	125	125							60167288	MCE110/C	11	15	22,4	307
CM-GE 125-2550	125	125							60167289 *	MCE150/C	15	20	30,5	363
CM-GE 150- 955	150	150							60191993	MCE55/C	5,5	7,5	10,6	274
CM-GE 150-1322	150	150							60167290	MCE110/C	7,5	10	14,4	294
CM-GE 150-1600	150	150							60167291 *	MCE110/C	11	15	22,4	306
CM-GE 150-1950	150	150							60167292 *	MCE150/C	15	20	30,5	356

\*Available with proportional differential pressure regulation ΔP-v



D+CONNECT  
 COMMAND AND CONTROL SYSTEMS  
 CIRCULATORS AND IN-LINE PUMPS  
 MULTISTAGE CENTRIFUGAL AND SELF-PRIMING PUMPS  
 SWIMMING POOL, POND AND SALT WATER PUMPS  
 CENTRIFUGAL PUMPS  
 SUBMERSIBLE PUMPS  
 SUBMERSIBLE PUMPS AND SUBMERSIBLE MOTORS  
 PRESSURE UNITS

# CME / CM-GE / DCME / DCM-GE - 4 POLES

ELECTRONIC IN-LINE PUMPS



## DCME/DCM-GE TWIN FLANGES WITH INVERTER MCE/C

MODEL	FLANGE DIMENS. (mm)		VOLTAGE 50/60 Hz - 1x220-240 ~ V					VOLTAGE 50 Hz - 3x400 ~ V						
	DNA	DNM	CODE	MODEL MCE	P2 NOMINAL		In A	WEIGHT (Kg)	CODE	MODEL MCE	P2 NOMINAL		In A	WEIGHT (Kg)
					kW	HP					kW	HP		
DCME 40-620	40	40	60142830	MCE11/C	0,25	0,33	4,7	45						
DCME 50-460	50	50	60142831 *	MCE11/C	0,25	0,35	4,7	50						
DCME 50-880	50	50	60142832 *	MCE11/C	0,5	0,67	7,2	56						
DCM-GE 65- 660	65	65	60163102 *	MCE11/C	0,55	0,75	7,3	141						
DCM-GE 65- 920	65	65	60192000 *	MCE11/C	0,75	1	9,8	144	60192020 *	MCE30/C	0,75	1	1,8	146
DCM-GE 65-1200	65	65	60192002 *	MCE11/C	1,5	2	15,4	193	60192025 *	MCE30/C	1,5	2	3,6	195
DCM-GE 65-1680	65	65							60192003 *	MCE30/C	3	4	6,8	206
DCM-GE 65-2380	65	65							60192004 *	MCE30/C	4	5,5	8,2	233
DCM-GE 80- 650	80	80	60192005 *	MCE11/C	0,75	1	9,8	134	60192021 *	MCE30/C	0,75	1	1,8	136
DCM-GE 80- 890	80	80	60192006 *	MCE11/C	1,5	2	13,9	211	60192022 *	MCE30/C	1,5	2	3,6	213
DCM-GE 80-1530	80	80							60192007 *	MCE30/C	3	4	6,8	251
DCM-GE 80-1700	80	80							60192008 *	MCE55/C	4	5,5	10,3	277
DCM-GE 80-2410	80	80							60192009 *	MCE55/C	5,5	7,5	10,6	442
DCM-GE 80-2700	80	80							60167293	MCE110/C	7,5	10	14,4	499
DCM-GE 80-3420	80	80							60167294 *	MCE110/C	11	15	22,4	533
DCM-GE 100- 510	100	100	60192012 *	MCE11/C	0,75	1	9,7	218	60192023	MCE30/C	0,75	1	1,8	220
DCM-GE 100-865	100	100	60192013 *	MCE22/C	2,2	3	20,7	261	60192024 *	MCE30/C	2,2	3	5,9	263
DCM-GE 100-1020	100	100							60192014 *	MCE30/C	3	4	6,8	264
DCM-GE 100-1320	100	100							60192015 *	MCE55/C	4	5,5	8,2	308
DCM-GE 100-1650	100	100							60192016 *	MCE55/C	5,5	7,5	10,6	351
DCM-GE 100-2050	100	100							60167295 *	MCE110/C	7,5	10	14,4	558
DCM-GE 100-2550	100	100							60167296 *	MCE110/C	11	15	22,4	565
DCM-GE 100-3290	100	100							60167297 *	MCE150/C	15	20	30,5	753
DCM-GE 125-1075	125	125							60192017 *	MCE55/C	4	5,5	8,2	501
DCM-GE 125-1270	125	125							60192018 *	MCE55/C	5,5	7,5	10,6	503
DCM-GE 125-1560	125	125							60167298 *	MCE110/C	7,5	10	14,4	538
DCM-GE 125-2100	125	125							60167299	MCE110/C	11	15	22,4	768
DCM-GE 125-2550	125	125							60167301 *	MCE150/C	15	20	30,5	880
DCM-GE 150- 955	150	150							60192019	MCE55/C	5,5	7,5	10,6	658
DCM-GE 150-1322	150	150							60167302	MCE110/C	7,5	10	14,4	693
DCM-GE 150-1600	150	150							60167303 *	MCE110/C	11	15	22,4	719
DCM-GE 150-1950	150	150							60167304 *	MCE150/C	15	20	30,5	818

\*Available with proportional differential pressure regulation ΔP-v

# ELECTRONIC IN-LINE PUMPS

PERFORMANCE RANGE

## CPE / CP-GE - HEATING, AIR CONDITIONING, SOLAR PANEL AND HOT WATER SYSTEM

MODEL	P2 NOMINAL		Q (m³/h) (l/min)	H* (m)																								
	kW	HP		0	3,6	4,8	6	12	18	24	30	36	42	48	54	60	66	72	78	84	90	102	114	120	150	180	210	
CPE 40/2300 M MCE11/C	1,1	1,5	21,8	21,8	21,3	21	18																					
CPE 40/2300 T MCE30/C	1,1	1,5	21,8	21,8	21,3	21	18																					
CPE 40/3500 M MCE22/C	2,2	3	34,8	34,9	34,7	34,2	31,7																					
CPE 40/3500 T MCE30/C	2,2	3	34,8	34,9	34,7	34,2	31,7																					
CPE 40/4700 T MCE55/C	4	5,5				47	44	39,5	35																			
CPE 40/5500 T MCE55/C	5,5	7,5				55	53	48	42																			
CPE 40/6200 T MCE110/C	7,5	10				62	59	54	49																			
CPE 50/2600 M MCE15/C	1,5	2				25	22	16																				
CPE 50/2600 T MCE30/C	1,5	2				25	22	16																				
CPE 50/4100 T MCE30/C	4	5,5				40,7	38,5	34,5	27,7																			
CPE 50/4600 T MCE55/C	5,5	7,5						44	41,5	37	31																	
CPE 50/5650 T MCE110/C	7,5	10						55,5	53	49	44																	
CP-GE 65-1470/A/BAQE/1.5 M MCE11/C	1,5	2	14,7			14,5	14,3	13,8	13	11,8	10,5	8,6	7															
CP-GE 65-1470/A/BAQE/1.5 T MCE30/C	1,5	2	14,7			14,5	14,3	13,8	13	11,8	10,5	8,6	7															
CP-GE 65-2280/A/BAQE/3 T MCE30/C	3	4	22,8			22,5	22,3	22	21,2	20,2	19	17,4	15,5	13,5														
CP-GE 65-2640/A/BAQE/4 T MCE30/C	4	5,5	26,4			26,2	26	25,6	25	24	23	21,5	19,5	17,5	15													
CP-GE 65-3400/A/BAQE/5.5 T MCE55/C	5,5	7,5	34					34	33,5	32,5	31	29,5	27	24														
CP-GE 65-4100/A/BAQE/7.5 T MCE110/C	7,5	10	41					41	41	40	39	37,5	35,5	33	30	26,5												
CP-GE 65-4700/A/BAQE/11 T MCE110/C	11	15	47							45,5	45	44,3	43,3	42	40,8	39	37	35	32,3									
CP-GE 65-5500/A/BAQE/15 T MCE150/C	15	20	55							56	55,5	54	53,5	52	51	49	47,5	45,5	43	41								
CP-GE 80-1400/A/BAQE/2.2 M MCE15/C	2,2	3	14							13,8	13,3	12,9	12,5	12,1	11,4	10,8	10	9,2	8,3	7,5								
CP-GE 80-1400/A/BAQE/2.2 T MCE30/C	2,2	3	14							13,8	13,3	12,9	12,5	12,1	11,4	10,8	10	9,2	8,3	7,5								
CP-GE 80-2050/A/BAQE/4 T MCE55/C	4	5,5	20,5							20	19,5	19,1	18,5	18	17,5	16,5	15,8	14,8	14	12,5	11,5							
CP-GE 80-2400/A/BAQE/5.5 T MCE55/C	5,5	7,5	24							23,6	23,5	23,2	22,8	22,2	21,5	21	20	19,1	18,5	17,5	16,5	13,4						
CP-GE 80-2770/A/BAQE/7.5 T MCE110/C	7,5	10	27,7											27,5	27,3	27,1	26,7	25,8	25,6	24,9	24,5	23	21,2	20,1				
CP-GE 80-3250/A/BAQE/11 T MCE110/C	11	15	32,5													32,2	32	31,8	31,3	30,2	30	29,2	28,7	27	24,8	23,6		
CP-GE 80-4000/A/BAQE/15 T MCE150/C	15	20	40													40,2	40	39,8	39,5	39	38,5	38,2	37,5	36	34,5	33,5	26,9	
CP-GE 100-1600/A/BAQE/4 T MCE55/C	4	5,5	16									15	14,6	14,2	13,7	13,3	12,8	12,3	11,7	11	10,4	9,3	8					
CP-GE 100-1950/A/BAQE/5.5 T MCE55/C	5,5	7,5	19,5									19	18,9	18,7	18,4	18,1	17,5	17,2	16,9	16,5	15,8	14,5	13	12				
CP-GE 100-2350/A/BAQE/7.5 T MCE110/C	7,5	10	23,5									23,1	23	22,8	22,6	22,5	22	21,6	21,1	20,7	20,2	19	17,5	14,8	12			
CP-GE 100-2400/A/BAQE/11 T MCE110/C	11	15	24																		22	21,4	20,4	20	17,4	16,8	12	
CP-GE 100-3050/A/BAQE/15 T MCE150/C	15	20	30,5																			29	28,4	27,5	27	24,5	21,3	18,3

# ELECTRONIC IN-LINE PUMPS

PERFORMANCE RANGE

## DCPE / DCP-GE - HEATING, AIR CONDITIONING, SOLAR PANEL AND HOT WATER SYSTEM

MODEL	P2 NOMINAL		Q <sub>3</sub> m <sup>3</sup> /h Q= l/min	6	7,5	9	10,5	12	13,5	15	18	21	24	27	30	36	42	48	54	60	180	210	
	KW	HP		100	125	150	175	200	225	250	300	350	400	450	500	600	700	800	900	1000	3000	3500	
DCPE 40/1650 M MCE11/C IE2	0,8	1	H (m)	16,5	15,5	14,5	13,5	12,3	11	9,5	6												
DCPE 40/2450 M MCE15/C IE2	1,5	2		24,5	24	23,5	23	22	21	20	16,5	13											
DCPE 40/2450 T MCE30/C IE2	1,5	2		24,5	24	23,5	23	22	21	20	16,5	13											
DCPE 50/1550 M MCE15/C IE2	1,5	2								15,5	15	14,1	13	11,8	10,5	7							
DCPE 50/1550 T MCE30/C IE2	1,5	2								15,5	15	14,1	13	11,8	10,5	7							
DCPE 50/2450 T MCE30/C IE2	3	4								24,5	24	23,5	23	22	20,5	17							
DCPE 50/3650 T MCE55/C IE2	4	5,5								36,5	35,5	34,5	33,5	32,5	31	27							

MODEL	P2 NOMINAL		Q <sub>3</sub> m <sup>3</sup> /h Q= l/min	0	6	12	18	24	30	36	42	48	54	60	66	72	78	84	90	102	114	120	150	180	210	
	KW	HP		0	100	200	300	400	500	600	700	800	900	1000	1100	1200	1300	1400	1500	1700	1900	2000	2500	3000	3500	
DCP-GE 65-1470/A/BAQE/1.5M MCE11/C	1,5	2	H (m)	14,4	14,2	13,8	13,1	12,0	10,6	9,0	7,0	5,3														
DCP-GE 65-1470/A/BAQE/1.5 T MCE30/C	1,5	2		14,4	14,2	13,8	13,1	12,0	10,6	9,0	7,0	5,3														
DCP-GE 65-2280/A/BAQE/3 T MCE30/C	3	4		22,3			21,1	19,9	18,4	16,8	14,7	12,5	10,2													
DCP-GE 65-2640/A/BAQE/4 T MCE55/C	4	5,5		25,9			24,6	23,7	22,2	20,7	18,8	16,4	14,0	11,4												
DCP-GE 65-3400/A/BAQE/5.5 T MCE55/C	5,5	7,7		33,3			32,5	31,4	29,7	27,4	25,0	21,7	18,2													
DCP-GE 65-4100/A/BAQE/7.5 T MCE110/C	7,5	10		40,2			39,6	39,0	37,4	35,7	33,4	30,7	27,5	23,9	20,1											
DCP-GE 65-4700/A/BAQE/11 T MCE110/C	11	15		46,4					44,3	43,6	42,6	41,3	39,6	38,1	35,9	33,6	31,3									
DCP-GE 65-5500/A/BAQE/15 T MCE150/C	15	20		54,3					54,7	53,9	52,1	51,2	49,4	48,0	45,6	43,7	41,3	38,4	36,1							
DCP-GE 80-1400/A/BAQE/2.2 M MCE30/C	2,2	3		13,7				14,3	13,7	13,0	12,3	11,4	10,3	9,1	7,8	6,5	5,2	4,0								
DCP-GE 80-1400/A/BAQE/2.2 T MCE30/C	2,2	3		13,7				14,3	13,7	13,0	12,3	11,4	10,3	9,1	7,8	6,5	5,2	4,0								
DCP-GE 80-2050/A/BAQE/4T MCE55/C	4	5,5		20,1				20,8	20,1	19,5	18,4	17,4	16,2	14,6	13,1	11,3	9,7	7,7	6,1							
DCP-GE 80-2400/A/BAQE/5.5 T MCE55/C	5,5	7,5		23,5				24,5	24,4	23,9	23,1	22,1	20,8	19,6	17,9	16,3	14,8	13,0	11,2	7,1						
DCP-GE 80-2770/A/BAQE/7.5 T MCE55/C	7,5	10		27,1								26,6	26,0	25,3	24,3	22,8	21,9	20,5	19,3	16,2	13,0	11,3				
DCP-GE 80-3250/A/BAQE/11 T MCE110/C	11	15		31,9								31,2	30,5	29,7	28,5	26,7	25,6	24,0	22,6	19,1	15,2	13,2				
DCP-GE 80-4000/A/BAQE/15 T MCE150/C	15	20		39,2								39,7	39,1	38,5	37,7	36,7	35,6	34,6	33,2	30,1	26,9	25,1	15,1			
DCP-GE 100-1600/A/BAQE/4 T MCE55/C	4	5,5		16,0						15,8	15,2	14,5	13,6	12,8	11,8	10,8	9,6	8,4	7,3	5,1	3,0					
DCP-GE 100-1950/A/BAQE/5.5 T MCE55/C	5,5	7,5		19,5						20,1	19,8	19,2	18,5	17,7	16,5	15,5	14,5	13,3	11,8	9,0	6,0	4,5				
DCP-GE100-2350/A/BAQE/7.5 T MCE110/C	7,5	10		23,5						24,5	24,4	24,0	23,6	23,1	22,2	21,4	20,4	19,4	18,3	15,7	12,9	11,7	4,5			
DCP-GE 100-2400/A/BAQE/11 T MCE110/C	11	15		23,6															21,9	21,0	19,7	19,1	15,5	13,4	8,2	
DCP-GE 100-3050/A/BAQE/15 T MCE150/C	15	20	30,0															28,9	27,9	26,5	25,8	21,8	17,0	12,5		



# CPE / CP-GE / DCPE / DCP-GE - 2 POLES

ELECTRONIC IN-LINE PUMPS



Circulation pumps with in-line ports, suitable for installation in heating and air conditioning, refrigeration, and domestic hot water systems. Extremely versatile thanks to the use of the **MCE/C** inverter, they offer performance capable of adapting automatically to the system's various demands while keeping pressure differentials unchanged. Available in single and twin version. PN 16 flanged inlet and delivery mouths, fitted with threaded holes for pressure gauges. Pump body and support in cast iron, impeller in cast iron or technopolymer depending on model (in bronze, on request, only from DN 65 to DN 150). Stainless steel drive shaft. Sealing device: standardised mechanical seal made to DIN 24960 in carbon / carborundum with O' rings in EPDM. 2 pole three-phase indication motor with external cooling. Rotor running on ball bearings, oversized to ensure low noise and durability. Constructed following the CEI 2-3 standards

**Operating range** from 1.2 to 230 m<sup>3</sup>/h with head up to 56 meters.

**Liquid temperature range** from -10°C to +130°C for DN 40 -50 from -10°C to +140°C for rest of the range

**Liquid quality requirements** clean, free from solids or abrasive substances, non viscous, non aggressive, non crystallised and chemically neutral and close to the characteristics of water.

**Installation** Fixed, horizontal or vertical provided the motor is always above the pump.

**Maximum ambient temperature** +40°C

**Maximum working pressure** 16 bar

**Protection rating** IP 55

**Insulation Class** F

**Flanging** PN 16

**Counter-flanges on request** DN 40 - DN 50 - DN 65 - DN 80 - DN 100 - DN 125 - DN 150; PN 16.



PAG. 5

MCE/C  
PAG. 22

ACCESSORIES  
PAG. 79

## CPE / CP-GE SINGLE FLANGES WITH INVERTER MCE/C

MODEL	FLANGE DIMENS. (mm)		VOLTAGE 50/60 Hz - 1x220-240 ~ V					VOLTAGE 50 Hz - 3x400 ~ V						
	DNA	DNM	CODE	MODEL MCE	P2 NOMINAL		In A	WEIGHT (Kg)	CODE	MODEL MCE	P2 NOMINAL		In A	WEIGHT (Kg)
					KW	HP					KW	HP		
CPE 40/2300	40	40	60142730 *	MCE11/C	1,1	1,5	12	49	60147376	MCE30/C	1,1	1,5	3	49
CPE 40/3500	40	40	60142510 *	MCE22/C	2,2	3,0	19,2	52	60147377 *	MCE30/C	2,2	3,0	5	52
CPE 40/4700	40	40							60142731	MCE55/C	4,0	5,5	5,5	58
CPE 40/5500	40	40							60142791 *	MCE55/C	5,5	7,5	10,6	63
CPE 40/6200	40	40							60142792 *	MCE110/C	7,5	10,0	14,4	64
CPE 50/2600	50	50	60142793	MCE15/C	1,5	2,0	14,4	49	60147378	MCE30/C	1,5	2,0	3,8	49
CPE 50/4100	50	50							60142794 *	MCE30/C	4,0	5,5	7,8	62
CPE 50/4600	50	50							60142511	MCE55/C	5,5	7,5	10,6	64
CPE 50/5650	50	50							60142795 *	MCE110/C	7,5	10,0	14,4	72
CP-GE 65-1470	65	65	60192030 *	MCE11/C	1,5	2	14,5	67	60192041 *	MCE30/C	1,5	2	3	69,6
CP-GE 65-2280	65	65							60192031 *	MCE30/C	3	4	5,6	88
CP-GE 65-2640	65	65							60192032 *	MCE30/C	4	5,5	8,2	95
CP-GE 65-3400	65	65							60191938 *	MCE55/C	5,5	7,5	10,2	128
CP-GE 65-4100	65	65							60167307 *	MCE110/C	7,5	10	14,4	131
CP-GE 65-4700	65	65							60167308 *	MCE110/C	11	15	19,9	209
CP-GE 65-5500	65	65							60167309 *	MCE150/C	15	20	26,8	227
CP-GE 80-1400	80	80	60192033 *	MCE15/C	2,2	3	20,7	86	60192042 *	MCE30/C	2,2	3	4,6	88,6
CP-GE 80-2050	80	80							60192034 *	MCE55/C	4	5,5	8,2	99
CP-GE 80-2400	80	80							60192035 *	MCE55/C	5,5	7,5	10,2	133
CP-GE 80-2770	80	80							60167310 *	MCE110/C	7,5	10	14,4	88
CP-GE 80-3250	80	80							60167311	MCE110/C	11	15	19,9	98
CP-GE 80-4000	80	80							60167313	MCE150/C	15	20	26,8	103
CP-GE 100-1600	100	100							60192036 *	MCE55/C	4	5,5	8,2	86
CP-GE 100-1950	100	100							60192037	MCE55/C	5,5	7,5	10,2	92
CP-GE 100-2350	100	100							60167315 *	MCE110/C	7,5	10	14,4	110
CP-GE 100-2400	100	100							60167316	MCE110/C	11	15	19,9	120
CP-GE 100-3050	100	100							60167317 *	MCE150/C	15	20	26,8	159

\*Available with proportional differential pressure regulation ΔP-v

D+CONNECT  
 COMMAND AND CONTROL SYSTEMS  
 CIRCULATORS AND IN-LINE PUMPS  
 MULTISTAGE CENTRIFUGAL AND SELF-PRIMING PUMPS  
 SWIMMING POOL, POND AND SALT WATER PUMPS  
 CENTRIFUGAL PUMPS  
 SUBMERSIBLE PUMPS  
 SUBMERSIBLE PUMPS AND SUBMERSIBLE MOTORS  
 PRESSURE UNITS

# CPE / CP-GE / DCPE / DCP-GE - 2 POLES

ELECTRONIC IN-LINE PUMPS



## DCPE / DCP-GE TWIN FLANGES WITH INVERTER MCE/C

MODEL	FLANGE DIMENS. (mm)		VOLTAGE 50/60 Hz - 1x220-240 ~ V						VOLTAGE 50 Hz - 3x400 ~ V					
	DNA	DNM	CODE	MODEL MCE	P2 NOMINAL		In A	WEIGHT (Kg)	CODE	MODEL MCE	P2 NOMINAL		In A	WEIGHT (Kg)
					kW	HP					kW	HP		
DCPE 40/1650	40	40	60142842	MCE11/C	0,75	1	9,0	54						
DCPE 40/2450	40	40	60142279 *	MCE15/C	1,5	2,0	15,8	58	60147384 *	MCE30/C	1,5	2,0	3,4	58
DCPE 50/1550	50	50	60142843	MCE15/C	1,5	2,0	15,8	60	60147385 *	MCE30/C	1,5	2,0	3,4	60
DCPE 50/2450	50	50							60142844 *	MCE30/C	3,0	4,0	5,9	75
DCPE 50/3650	50	50							60142845 *	MCE55/C	4,0	5,5	7,8	95
DCP-GE 65-1470	65	65	60192043 *	MCE11/C	1,5	2	14,5	148	60192056 *	MCE30/C	1,5	2	3	150
DCP-GE 65-2280	65	65							60192044 *	MCE30/C	3	4	5,6	193
DCP-GE 65-2640	65	65							60192045 *	MCE55/C	4	5,5	8,2	206
DCP-GE 65-3400	65	65							60192055 *	MCE55/C	5,5	7,7	10,2	272
DCP-GE 65-4100	65	65							60167318 *	MCE110/C	7,5	10	14,4	284
DCP-GE 65-4700	65	65							60167319 *	MCE110/C	11	15	19,9	423
DCP-GE 65-5500	65	65							60167320 *	MCE150/C	15	20	26,8	459
DCP-GE 80-1400	80	80	60192049 *	MCE22/C	2,2	3	20,7	177	60192057 *	MCE30/C	2,2	3	4,6	179
DCP-GE 80-2050	80	80							60192050 *	MCE55/C	4	5,5	8,2	195
DCP-GE 80-2400	80	80							60192051 *	MCE55/C	5,5	7,5	10,2	264
DCP-GE 80-2770	80	80							60167321 *	MCE55/C	7,5	10	14,4	186
DCP-GE 80-3250	80	80							60167322	MCE110/C	11	15	19,9	204
DCP-GE 80-4000	80	80							60167323 *	MCE150/C	15	20	26,8	214
DCP-GE 100-1600	100	100							60192052	MCE55/C	4	5,5	8,2	183
DCP-GE 100-1950	100	100							60192053	MCE55/C	5,5	7,5	10,2	197
DCP-GE 100-2350	100	100							60167324 *	MCE110/C	7,5	10	14,4	230
DCP-GE 100-2400	100	100							60167325	MCE110/C	11	15	19,9	273
DCP-GE 100-3050	100	100							60167326 *	MCE150/C	15	20	26,8	352

\*Available with proportional differential pressure regulation ΔP-v

D+CONNECT  
 COMMAND AND CONTROL SYSTEMS  
 CIRCULATORS AND IN-LINE PUMPS  
 MULTISTAGE CENTRIFUGAL AND SELF-PRIMING PUMPS  
 SWIMMING POOL, POND AND SALT WATER PUMPS  
 CENTRIFUGAL PUMPS  
 SUBMERSIBLE PUMPS  
 SUBMERSIBLE PUMPS AND SUBMERSIBLE MOTORS  
 PRESSURE UNITS

# ALM / ALP

IN-LINE PUMPS



Circulating pumps with in-line **connections**, suitable for civil and industrial installations for heating, air-conditioning and hot water for **domestic use**.

Technopolymer impeller and carbon/ceramic mechanical seal. Two-pole, asynchronous motor for the ALP version and four-pole for the ALM version.

Built-in thermal and current overload protection and a capacitor permanently on in the single-phase version. Three-phase motors should be protected with a suitable overload protection complying with the regulations in force.

**Pump body and motor support in bronze.**

### Operating range

from 0,6 to 6,5 m<sup>3</sup>/h with head up to 7,7 metres.

### Liquid temperature range

from +15°C to +120°C.

**Pumped liquid characteristics** clean, free from solids or abrasive substances, not viscous, not aggressive, not crystallised, chemically neutral, close to the characteristics of water.

**Maximum ambient temperature** + 40°C

**Maximum working pressure** 10 bar (1000 kPa).

**Protection level** IP 55

**Insulation class** F

ACCESSORIES  
PAG. 79

## ALM 200 /ALP 800

ALM - 1400 r.p.m. 1/min - 4 poles

ALP - 2800 r.p.m. 1/min - 2 poles

MODEL	CODE	CENTRE DISTANCE	PUMP COUPLINGS	ELECTRICAL DATA			HYDRAULIC DATA						WEIGHT Kg	Q.TY X PALLET			
				VOLTAGE 50 Hz	P2 NOMINAL		In A	Q=m <sup>3</sup> /h	0	1,2	2,4	3,6			4,8	6	
					kW	HP		Q=l/min	0	20	40	60			80	100	
ALM 200 M	105100004	180	1 1/2"	1x220-240V ~	0,059	0,08	0,7	H (m)	1,9	1,65	1					7,5	39
ALM 200 T	105100014	180	1 1/2"	3x230-400V~	0,059	0,08	0,53-0,3		1,9	1,65	1					7,5	39
ALP 800 M	105100084	180	1 1/2"	1x220-240V ~	0,37	0,5	1,4		7,7	7,2	6,3	5,8	3,9	2	7,5	39	
ALP 800 T	105100094	180	1 1/2"	3x230-400V~	0,37	0,5	1,2-0,7		7,7	7,2	6,3	5,8	3,9	2	7,5	39	

# ALM / ALP

IN-LINE PUMPS



Circulating pumps with in-line **connections**, suitable for civil and industrial installations for heating, air-conditioning and hot water for **domestic use**.

Technopolymer impeller and carbon/ceramic mechanical seal. Two-pole, asynchronous motor for the ALP version and four-pole for the ALM version.

Built-in thermal and current overload protection and a capacitor permanently on in the single-phase version. Three-phase motors should be protected with a suitable overload protection complying with the regulations in force.

**Pump body and motor support in cast iron.**

### Operating range

from 1,5 to 8,4 m<sup>3</sup>/h with head up to 21 metres.

### Liquid temperature range

from +15°C to +120°C.

**Pumped liquid characteristics** clean, free from solids or abrasive substances, not viscous, not aggressive, not crystallised, chemically neutral, close to the characteristics of water.

**Maximum ambient temperature** + 40°C

**Maximum working pressure** 10 bar (1000 kPa).

**Protection level** IP 55

**Insulation class** F

ACCESSORIES  
PAG. 79

## ALM 500 /ALP 2000

ALM - 1400 r.p.m. 1/min - 4 poles

ALP - 2800 r.p.m. 1/min - 2 poles

MODEL	CODE	CENTRE DISTANCE	PUMP COUPLINGS	ELECTRICAL DATA			HYDRAULIC DATA								WEIGHT KG	Q.TY X PALLET		
				VOLTAGE 50 Hz	P2 NOMINAL		In A	Q=m <sup>3</sup> /h	0	1,2	2,4	3,6	4,8	6			7,2	8,4
					kW	HP		Q=l/min	0	20	40	60	80	100			120	140
ALM 500 M	105100024	250	2" G-M	1x220-240V ~	0,25	0,33	1	H (m)	5,5	5,4	5,3	4,8	4,1	3	1,5		14,5	21
ALM 500 T	105100034	250	2" G-M	3x230-400V~	0,25	0,33	1-0,6		5,5	5,4	5,3	4,8	4,1	3	1,5		14,5	21
ALP 2000 M	105100124	250	2" G-M	1x220-240V ~	0,55	0,75	3,7		21,1	20,6	19,6	18	16	13,8	10,5	5,3	14,5	21
ALP 2000 T	105100134	250	2" G-M	3x230-400V~	0,55	0,75	2,3-1,3		21,1	20,6	19,6	18	16	13,8	10,5	5,3	14,5	21



# KLM / KLP / DKLM / DKLP

IN-LINE PUMPS

## DKLM/DKLP

DKLM - 1400 r.p.m. 1/min - 4 poles  
DKLP - 2800 r.p.m. 1/min - 2 poles

MODEL	CODE	CENTRE DIST.	PUMP COUP.	ELECTRICAL DATA			HYDRAULIC DATA																WEIGHT KG	Q.TY X PAL.					
				VOLTAGE 50 Hz	P2 NOMINAL		In A	Q=m³h		0	2,4	3,6	4,8	6	7,2	8,4	9,6	12	14,4	16,8	18	24			30	36	48	60	72
					kW	HP		0	40	60	80	100	120	140	160	200	240	280	300	400	500	600			800	1000	1200		
DKLM 40-300 M	105210404	250	DN 40	1 x 220 - 240 V ~	0,10	0,14	1,12	H (m)																38,2	8				
DKLM 40-300 T	105210014	250	DN 40	3 x 230 - 400 V ~	0,10	0,14	1,04-0,6	H (m)																38,2	8				
DKLP 40-600 M	105210414	250	DN 40	1 x 220 - 240 V ~	0,30	0,41	3,29	H (m)																41,8	8				
DKLP 40-600 T	105210214	250	DN 40	3 x 230 - 400 V ~	0,30	0,41	2,13-1,23	H (m)																41,8	8				
DKLP 40-900 M	105210424	250	DN 40	1 x 220 - 240 V ~	0,41	0,56	3,75	H (m)																41,8	8				
DKLP 40-900 T	105210224	250	DN 40	3 x 230 - 400 V ~	0,41	0,56	2,37-1,37	H (m)																41,8	8				
DKLP 40-1200 M	105210434	250	DN 40	1 x 220 - 240 V ~	0,54	0,73	4,40	H (m)																41,8	8				
DKLP 40-1200 T	105210234	250	DN 40	3 x 230 - 400 V ~	0,54	0,73	2,70-1,56	H (m)																41,8	8				
DKLP 40-1600 M	60181145	250	DN 40	1 x 220 - 240 V ~	0,75	1,01	4,71	H (m)																45,8	8				
DKLP 40-1600 T	60182125	250	DN 40	3 x 230 - 400 V ~	0,75	1,01	3,44-1,91	H (m)																45,8	8				
DKLP 40-1800 M	60179338	250	DN 40	1 x 220 - 240 V ~	0,85	1,16	5,44	H (m)																45,8	8				
DKLP 40-1800 T	60180551	250	DN 40	3 x 230 - 400 V ~	0,85	1,15	3,29-1,88	H (m)																45,8	8				
DKLM 50-300 M	105210444	280	DN 50	1 x 220 - 240 V ~	0,11	0,15	1,10	H (m)																51	2				
DKLM 50-300 T	105210054	280	DN 50	3 x 230 - 400 V ~	0,11	0,15	1,02-0,59	H (m)																51	2				
DKLM 50-600 M	105210454	280	DN 50	1 x 220 - 240 V ~	0,22	0,30	1,55	H (m)																52	2				
DKLM 50-600 T	105210074	280	DN 50	3 x 230 - 400 V ~	0,22	0,30	1,28-0,74	H (m)																52	2				
DKLP 50-900 M	105210464	280	DN 50	1 x 220 - 240 V ~	0,51	0,69	4,02	H (m)																54	2				
DKLP 50-900 T	60179386	280	DN 50	3 x 230 - 400 V ~	0,51	0,69	3,39-1,96	H (m)																54	2				
DKLP 50-1200 M	105210474	280	DN 50	1 x 220 - 240 V ~	0,72	0,98	4,93	H (m)																54,2	2				
DKLP 50-1200 T	60179385	280	DN 50	3 x 230 - 400 V ~	0,72	0,97	3,72-2,15	H (m)																54,2	2				
DKLP 50-1600 M	60181604	280	DN 50	1 x 220 - 240 V ~	1,01	1,37	7,15	H (m)																54,5	2				
DKLP 50-1600 T	60182122	280	DN 50	3 x 230 - 400 V ~	1,01	1,38	4,05-2,32	H (m)																54,5	2				
DKLP 50-2000 M	60180613	280	DN 50	1 x 220 - 240 V ~	1,83	2,49	11,06	H (m)																58,5	2				
DKLP 50-2000 T	60182123	280	DN 50	3 x 230 - 400 V ~	1,83	2,49	6,77-3,9	H (m)																58,5	2				
DKLM 65-300 T	105210094	340	DN 65	3 x 230 - 400 V ~	0,15	0,20	1,07-0,62	H (m)																55	2				
DKLM 65-600 T	105210114	340	DN 65	3 x 230 - 400 V ~	0,24	0,33	1,30-0,75	H (m)																62	2				
DKLP 65-900 T	60180058	340	DN 65	3 x 230 - 400 V ~	0,80	1,09	5,05-2,92	H (m)																66	2				
DKLP 65-1200 T	60179901	340	DN 65	3 x 230 - 400 V ~	1,12	1,52	5,64-3,26	H (m)																66,2	2				
DKLP 65-1600 T	60182117	340	DN 65	3 x 230 - 400 V ~	1,65	2,25	6,49-3,75	H (m)																66,5	2				
DKLP 65-2000 T	60182121	340	DN 65	3 x 230 - 400 V ~	2,00	2,72	7,7-4,5	H (m)																72,5	2				
DKLM 80-300 T	105210134	360	DN 80	3 x 230 - 400 V ~	0,25	0,33	1,20,7	H (m)																62	2				
DKLM 80-600 T	60180059	360	DN 80	3 x 230 - 400 V ~	0,75	1	2,8/1,6	H (m)																70	2				
DKLP 80-900 T	60180060	360	DN 80	3 x 230 - 400 V ~	1,84	2,5	5,2/3	H (m)																78	2				
DKLP 80-1200 T	60179926	360	DN 80	3 x 230 - 400 V ~	1,84	2,5	6,6/3,8	H (m)																78	2				
DKLP 80-1600 T	60182115	360	DN 80	3 x 230 - 400 V ~	2,55	3,5	10,28-5,94	H (m)																81,2	2				
DKLP 80-2000 T	60182116	360	DN 80	3 x 230 - 400 V ~	3,67	5,0	14,9-8,42	H (m)																93,2	2				

Blank counterflange supplied as standard for twin version

# CM / CM-G / DCM / DCM-G - 4 POLES

IN-LINE PUMPS



Circulating pumps with in-line connections, suitable for civil and industrial installations for heating, air-conditioning and hot water for domestic use. Pump body, motor support, impeller and fan cover in cast iron.

PN 16 flanged suction and delivery connections with threaded holes for control pressure gauges.

Carbon/ceramic mechanical seal.

Three-phase, four-pole, asynchronous motor with external ventilation. To protect the motor it is advisable to use a thermal overload protection complying with the regulations in force.

**Operating range**  
from 1,2 to 420 m<sup>3</sup>/h with head up to 41 metres.

**Liquid temperature range**  
from -10°C to +140°C.

**Pumped liquid characteristics** clean, free from solids or abrasive substances, not viscous, not aggressive, not crystallised and chemically neutral.

**Maximum ambient temperature** +40°C

**Maximum working pressure** 16 bar (1600 kPa).

**Protection level** IP 55

**Insulation class** F

PN 16 counter flanges on request.

IE3 ≥ 0,75 kW

ACCESSORIES  
PAG. 79

## CM / CM-G SINGLE WITH OVAL FLANGES

MODEL	CODE	CENTRE DISTANCE	PUMP COUPLINGS	ELECTRICAL DATA						HYDRAULIC DATA																WEIGHT KG					
				VOLTAGE 50 Hz	P1 MAX kW	P2 NOMINAL kW	HP	In (A) 230	In (A) 400	Q=m <sup>3</sup> /h 0	Q=l/min 0	1,2	2,4	3	3,6	4,8	6	12	18	24	30	36	42	48							
CM 40-440 T	60180063	390	DN 40	3 x 230 - 400V ~	0,28	0,75	1,00	2,2	1,3		4,4	4,4	4,3	4,3	4,2	4	3,6														41
CM 40-540 T	60180064	390	DN 40	3 x 230 - 400V ~	0,33	0,75	1,00	2,4	1,4		5,6	5,6	5,6	5,6	5,5	5,4	5	1,8													41
CM 40-670 T	60180065	390	DN 40	3 x 230 - 400V ~	0,39	0,75	1,00	2,2	1,3		6,9	6,9	6,9	6,9	6,8	6,6	6,3	3,2													41
CM 40-870 T	60180066	390	DN 40	3 x 230 - 400V ~	0,51	0,75	1,00	2,5	1,45		8,7	8,7	8,6	8,6	8,5	8,4	8,3	5,1													41
CM 40-1300 T	60180067	380	DN 40	3 x 230 - 400V ~	1,1	0,75	1,00	3,3	1,9					13	12,9	12,5	12,4	9,8	6												30
CM 40-1450 T	60180068	380	DN 40	3 x 230 - 400V ~	1,2	1,10	1,50	4,3	2,5							14,4	14,3	11,8	8												30
CM 50-510 T	60180069	425	DN 50	3 x 230 - 400V ~	0,35	0,75	1,00	2,4	1,4						5	4,6	4,2														46,6
CM 50-630 T	60180070	425	DN 50	3 x 230 - 400V ~	0,5	0,75	1,00	2,4	1,4							6,2	5,8	5,5													46,6
CM 50-780 T	60180071	425	DN 50	3 x 230 - 400V ~	0,5	0,75	1,00	2,5	1,44							7,7	7,4	7,1													46,6
CM 50-1000 T	60180072	425	DN 50	3 x 230 - 400V ~	0,64	0,75	1,00	2,94	1,7							10,1	9,8	9,6	6,8												46,6
CM 50-1270 T	60180073	400	DN 50	3 x 230 - 400V ~	1,4	1,10	1,50	4,3	2,5									12,7	11,2	8,5											36
CM 50-1420 T	60180074	400	DN 50	3 x 230 - 400V ~	1,4	1,10	1,50	4,3	2,5									14,2	13	10	6										36
CM-G 65-420/A/BAQE/0,25	1D4111GX3	360	DN 65	3 x 230 - 400V ~	0,4	0,25	0,33	1,6	0,9		4,2						4,1	3,7	3	2,1											55
CM-G 65-540/A/BAQE/0,37	1D4111G13	360	DN 65	3 x 230 - 400V ~	0,6	0,37	0,50	1,7	0,98		5,4							5,3	5	4,4	3,5										55
CM-G 65-660/A/BAQE/0,55	1D4111G23	360	DN 65	3 x 230 - 400V ~	0,8	0,55	0,75	2,6	1,5		6,6							6,5	6,2	5,7	4,8										65
CM-G 65-760/A/BAQE/0,55	1D4211G23	360	DN 65	3 x 230 - 400V ~	0,8	0,55	0,75	2,6	1,5		7,6							7,7	7,6	6,7	5,5										73
CM-G 65-920/A/BAQE/0,75	1D4211G3W	360	DN 65	3 x 230 - 400V ~	1,2	0,75	1,00	3,1	1,8		9,2							9,2	9	8,4	7,4	5,7									67
CM-G 65-1080/A/BAQE/1,1	1D4311G4W	475	DN 65	3 x 230 - 400V ~	1,6	1,10	1,50	4,3	2,5		10,8								10,8	10,6	10,2	9,5	8,6	7,3							77
CM-G 65-1200/A/BAQE/1,5	1D4311G5W	475	DN 65	3 x 230 - 400V ~	2,0	1,50	2,00	6,2	3,6		12								12	11,9	11,5	10,8	10,1	8,9							71
CM-G 65-1530/A/BAQE/2,2	1D4311G6W	475	DN 65	3 x 230 - 400V ~	2,9	2,20	3,00	10,2	5,9		15,3									15,3	15,2	14,8	14	13,3	12,1	10,8					86
CM-G 65-1680/A/BAQE/3	1D4311G7X	475	DN 65	3 x 400 V ~ <sup>1</sup>	2,7	3,00	4,00	-	6,8		16,8									16,8	16,5	16,1	15,5	14,6	13,6	12,4					72
CM-G 65-2380/A/BAQE/4	1D4411G8X	475	DN 65	3 x 400 V ~ <sup>1</sup>	4,3	4,00	5,50	-	8,2		23,8										24	23,8	23,4	22,7	21,6	20,4	19				92

<sup>1</sup> Star (Λ) starting is possible

# CM / CM-G / DCM / DCM-G - 4 POLES

IN-LINE PUMPS



## CM / CM-G SINGLE WITH OVAL FLANGES

MODEL	CODE	CENTRE DISTANCE	PUMP COUPLINGS	ELECTRICAL DATA						HYDRAULIC DATA																	WEIGHT KG	
				VOLTAGE 50 Hz	P1 MAX kW	P2 NOMINAL kW	HP	In (A) 230 400	Q=l/min	0	12	18	24	30	36	42	48	60	72	84	90	102	114	120	150	180		
CM-G 80-850/ A/BAQE/0,55	1D5111G23	360	DN 80	3x230-400V~	0,8	0,55	0,75	2,6	1,5	H (m)	5,5	5,2	5	4,7	4,3	3,9	3,3	2,6										67
CM-G 80-650/ A/BAQE/0,75	1D5111G3W	360	DN 80	3x230-400V~	1,2	0,75	1,00	3,1	1,8		6,5	6,3	6,1	5,8	5,5	5	4,5	3,9										61
CM-G 80-740/ A/BAQE/1,1	1D5211G4W	440	DN 80	3x230-400V~	1,5	1,10	1,50	4,3	2,5		7,4	7,4	7,3	7,2	6,9	6,7	6,3	5,8	4,4									68
CM-G 80-890/ A/BAQE/1,5	1D5211G5W	440	DN 80	3x230-400V~	2	1,50	2,00	6,2	3,6		8,9		8,8	8,7	8,6	8,3	8	7,6	6,6									67
CM-G 80-1050/ A/BAQE/2,2	1D5211G6W	440	DN 80	3x230-400V~	2,4	2,20	3,00	10,2	5,9		10,5			10,4	10,3	10,2	9,9	9,6	8,8									80
CM-G 80-1530/ A/BAQE/3	1D5311G7X	500	DN 80	3x400V~ 1	3,6	3,00	4,00	-	6,8		15,3			15,4	15,3	15	14,6	14,1	12,9	11,3								81
CM-G 80-1700/ A/BAQE/4	1D5311G8X	500	DN 80	3x400V~ 1	3,9	4,00	5,50	-	8,2		17			17,2	17,2	17,1	16,8	16,5	15,7	14,3	12,6							98
CM-G 80-2410/ A/BAQE/5,5	1D5411G9X	620	DN 80	3x400V~ 1	6,5	5,50	7,50	-	10,6		24,1			23,8	23,6	23,3	22,8	22,3	20,8	18,6								204
CM-G 80-2700/ A/BAQE/7,5	1D5511GAX	620	DN 80	3x400V~ 1	8,7	7,50	10,00	-	14,4		27						26	25,5	24,5	22,7	20,2	19						187
CM-G 80-3420/ A/BAQE/11	1D5511GBX	620	DN 80	3x400V~ 1	12,7	11,00	15,00	-	22,4		34,2						33,2	33	32	30,7	29	28	25	21,7				277
CM-G 100-510/ A/BAQE/0,75	1D6111G3W	500	DN 100	3x230-400V~	1,2	0,75	1,00	3,1	1,8		5,1	4,9	4,8	4,7	4,7	4,4	4,2	3,8	3									78
CM-G 100-650/ A/BAQE/1,1	1D6111G4W	500	DN 100	3x230-400V~	1,4	1,10	1,50	4,3	2,5		6,5	6,4	6,4	6,3	6,2	6	5,8	5,5	4,6									78
CM-G 100-660/ A/BAQE/1,5	1D6211G5W	550	DN 100	3x230-400V~	2	1,50	2,00	6,2	3,6		6,6				6,4	6,3	6,2	6	5,6	5	4,5	4,3	3,7	3				95
CM-G 100-865/ A/BAQE/2,2	1D6211G6W	550	DN 100	3x230-400V~	3	2,20	3,00	10,2	5,9		8,6				8,5	8,5	8,3	8,2	7,7	7,2	6,7	6,3	5,7	4,9	4,6			108
CM-G 100-1020/ A/BAQE/3	1D6211G7X	550	DN 100	3x400V~ 1	3,6	3,00	4,00	-	6,8		10,2				10,2	10,1	10	9,9	9,7	9,3	8,8	8,6	7,9	7,2	6,7			102
CM-G 100-1320/ A/BAQE/4	1D6311G8X	550	DN 100	3x400V~ 1	4,6	4,00	5,50	-	8,2		13,2						13,2	13,2	12,9	12,4	11,7	11,3	10,4	9,3	8,7			137
CM-G 100-1650/ A/BAQE/5,5	1D6311G9X	550	DN 100	3x400V~ 1	6,9	5,50	7,50	-	10,6		16,5						16,6	16,5	16,2	16	15,4	15	14,3	13,3	12,7			182
CM-G 100-2050/ A/BAQE/7,5	1D6411GAX	670	DN 100	3x400V~ 1	8,5	7,50	10,00	-	14,4		20,5						21	21	20,7	20	19,5	19	18	16,7	16			230
CM-G 100-2550/ A/BAQE/11	1D6411GBX	670	DN 100	3x400V~ 1	12,1	11,00	15,00	-	22,4		25,5						25,5	25,5	25,1	25	24,2	24	23	21,5	21			323
CM-G 100-3290/ A/BAQE/15	1D6511GCX	670	DN 100	3x400V~ 1	17,1	15,00	20,00	-	30,5		32,9							33	32,8	32	31,6	30,5	29,5	28,9	24			333
CM-G 100-3680/ A/BAQE/18,5	1D6511GDX	670	DN 100	3x400V~ 1	19,6	18,50	25,00	-	34,3	36,8							37	36,8	36,5	36,1	35,5	34,5	34	29,5			359	
CM-G 100-4100/ A/BAQE/22	1D6511GEX	670	DN 100	3x400V~ 1	22,4	22,00	30,00	-	40,2	41							41,4	41	40,6	40,5	39,8	39	38,5	34,8	29		370	

<sup>1</sup> Star (Δ) starting is possible

COMMAND AND CONTROL SYSTEMS

CIRCULATORS AND IN-LINE PUMPS

MULTISTAGE CENTRIFUGAL AND SELF-PRIMING PUMPS

SWIMMING POOL, POND AND SALT WATER PUMPS

CENTRIFUGAL PUMPS

SUBMERSIBLE PUMPS

SUBMERSIBLE PUMPS AND SUBMERSIBLE MOTORS

PRESSURE UNITS

# CM / CM-G / DCM / DCM-G - 4 POLES

IN-LINE PUMPS



## CM / CM-G SINGLE WITH OVAL FLANGES

MODEL	CODE	CENTRE DISTANCE	PUMP COUPLINGS	ELECTRICAL DATA				HYDRAULIC DATA													WEIGHT KG
				VOLTAGE 50 Hz	P1 MAX kW	P2 NOMINAL		In (A)	Q=m³h	0	60	72	84	90	102	114	120	150	180	210	
						kW	HP	400	Q=l/min	0	1000	1200	1400	1500	1700	1900	2000	2500	3000	3500	
CM-G 125-1075/A/BAQE/4	1D7311G8X	620	DN 125	3 x 400 V ~ 1	5,1	4,00	5,50	8,2	H (m)	10,8	10,1	10	9,7	9,5	9,1	8,5	8,3	7	5,4		191
CM-G 125-1270/A/BAQE/5,5	1D7311G9X	620	DN 125	3 x 400 V ~ 1	7,2	5,50	7,50	10,6		12,7	12,6	12,5	12,4	12,3	12	11,5	11,4	10,1	8,5		237
CM-G 125-1560/A/BAQE/7,5	1D7311GAX	620	DN 125	3 x 400 V ~ 1	9,5	7,50	10,00	14,4		15,6	15,4	15,3	15,1	15	14,7	14,5	14,3	13,3	11,6	9,8	218
CM-G 125-2100/A/BAQE/11	1D7411GBX	800	DN 125	3 x 400 V ~ 1	13,6	11,00	15,00	22,4		21	21,5	21,5	21,2	21	20,9	20	19,8	18	16		311
CM-G 125-2550/A/BAQE/15	1D7411GCX	800	DN 125	3 x 400 V ~ 1	16,3	15,00	20,00	30,5		25,5	25,5	25,5	25,1	25,1	25	24,5	24	22,5	20,5	17,5	321
CM-G 125-3200/A/BAQE/18,5	1D7511GDX	800	DN 125	3 x 400 V ~ 1	17,9	18,50	25,00	34,3		32			31,5	31,4	31	30,5	28,8	26	23		346
CM-G 125-3600/A/BAQE/22	1D7511GEX	800	DN 125	3 x 400 V ~ 1	22,4	22,00	30,00	40,2		36			35,5	35,2	35	34,6	33,2	31	28	24	357
CM-G 125-4022/A/BAQE/30	1D7511GFX	800	DN 125	3 x 400 V ~ 1	26,5	30,00	40,00	53,7		40,2			39,7	39,3	39,1	38,7	37,1	34,6	31,3	26,8	453

MODEL	CODE	CENTRE DISTANCE	PUMP COUPLINGS	ELECTRICAL DATA				HYDRAULIC DATA													WEIGHT KG				
				VOLTAGE 50 Hz	P1 MAX kW	P2 NOMINAL		In (A)	Q=m³h	0	84	90	102	114	120	150	180	210	250	300		360	390	420	
						kW	HP	400	Q=l/min	0	1400	1500	1700	1900	2000	2500	3000	3500	4167	5000	6000	6500	7000		
CM-G 150-955/A/BAQE/5,5	1D8411G9X	800	DN 150	3 x 400 V ~ 1	7,5	5,50	7,50	10,6	H (m)	9,6		9,6	9,6	9,4	9,3	8,7	7,8	6,7	5,5						298
CM-G 150-1322/A/BAQE/7,5	1D8411GAX	800	DN 150	3 x 400 V ~ 1	8,9	7,50	10,00	14,4		13,2		13	12,8	12,6	12,5	11,9	11,1	10,1	8,5						279
CM-G 150-1600/A/BAQE/11	1D8411GBX	800	DN 150	3 x 400 V ~ 1	13	11,00	15,00	22,4		16			15,5	15,5	15,4	14,8	14	13	11	9,2					327
CM-G 150-1950/A/BAQE/15	1D8411GCX	800	DN 150	3 x 400 V ~ 1	17,5	15,00	20,00	30,5		19,5			19,5	19,4	19,3	19,2	18,7	17,8	16	14,1	10,9				337
CM-G 150-2200/A/BAQE/18,5	1D8411GDX	800	DN 150	3 x 400 V ~ 1	21,1	18,50	25,00	34,3		22			22	21,9	21,8	21,7	21,4	20,5	19	17,2	14	12			361
CM-G 150-2405/A/BAQE/22	1D8411GEX	800	DN 150	3 x 400 V ~ 1	23,8	22,00	30,00	40,2		24,1			23,9	23,9	23,8	23,6	23,2	22,7	21,8	20,2	17,5	15,6	14		373

<sup>1</sup> Star (★) starting is possible



# CM / CM-G / DCM / DCM-G - 4 POLES

IN-LINE PUMPS



## DCM / DCM-G TWIN FLANGES

MODEL	CODE	CENTRE DISTANCE	PUMP COUPLINGS	ELECTRICAL DATA							HYDRAULIC DATA															WEIGHT KG
				VOLTAGE 50 Hz	P1 MAX kW	P2 NOMINAL kW	HP	In (A)		Q=m³/h																
								230	400		Q=l/min	30	40	50	75	100	150	175	200	225	250	300				
DCM 40/380 T	105222100	340	DN 40	3x230-400V ~	0,41	0,25	0,33	1,6	0,9	H (m)		1,8	2,4	3,0	4,5	6	9	10,5	12	13,5	15	18	41			
DCM 40/460 T	105222110	340	DN 40	3x230-400V ~	0,41	0,25	0,33	1,6	0,9				4,6	4,5	4,1	3,6	2,2								41	
DCM 40/620 T	105222120	340	DN 40	3x230-400V ~	0,41	0,25	0,33	1,6	0,9					6,2	6	5,8	4,5	3,9	3							41
DCM 50/460 T	105222130	365	DN 50	3x230-400V ~	0,41	0,25	0,33	1,6	0,9							4,6	4,3	4,1	3,9	3,6	3,3	2,4				46
DCM 50/630 T	105222140	365	DN 50	3x230-400V ~	0,57	0,37	0,50	2,1	1,2							6,3	6,1	6	5,8	5,5	5,2	4,6				46
DCM 50/880 T	105222150	410	DN 50	3x230-400V ~	0,79	0,50	0,70	2,9	1,7							8,8	8,3	8	7,7	7,3	6,9	5,9				52

MODEL	CODE	CENTRE DISTANCE	PUMP COUPLINGS	ELECTRICAL DATA							HYDRAULIC DATA															WEIGHT KG		
				VOLTAGE 50 Hz	P1 MAX kW	P2 NOMINAL kW	HP	In (A)		Q=m³/h																		
								230	400		Q=l/min	0	6	12	18	24	30	36	42	48	54							
DCM-G 65-420/A/BAQE/0,25	60162116	360	DN 65	3x230-400V ~	0,4	0,25	0,33	1,6	0,9	H (m)	4,2	3,5	2,7	1,7	0,5												112	
DCM-G 65-540/A/BAQE/0,37	60162117	360	DN 65	3x230-400V ~	0,6	0,37	0,50	1,7	1		5,4	5,2	4,4	3,3	1,6													112
DCM-G 65-660/A/BAQE/0,55	60162118	360	DN 65	3x230-400V ~	0,8	0,55	0,75	2,6	1,5		6,5	6,4	5,6	4,4	2,6													136
DCM-G 65-760/A/BAQE/0,55	60162119	360	DN 65	3x230-400V ~	0,8	0,55	0,75	2,6	1,5		7,5	7,6	6,9	5,4	3,1													135
DCM-G 65-920/A/BAQE/0,75	60180075	360	DN 65	3x230-400V ~	1,2	0,75	1,00	3,1	1,8		9,1	9,1	8,6	7,5	5,8	3,8												126
DCM-G 65-1080/A/BAQE/1,1	60180076	475	DN 65	3x230-400V ~	1,6	1,10	1,50	4,3	2,5		10,8		10,7	10,4	9,7	8,8	7,7	6,2										163
DCM-G 65-1200/A/BAQE/1,5	60180077	475	DN 65	3x230-400V ~	2,0	1,50	2,00	6,2	3,6		12,0		11,9	11,6	11,0	10,0	9,0	7,6										161
DCM-G 65-1530/A/BAQE/2,2	60180078	475	DN 65	3x230-400V ~	2,9	2,20	3,00	10,2	5,9		15,3		15,2	15,0	14,4	13,4	12,5	11,0	9,5	8,0								173
DCM-G 65-1680/A/BAQE/3	60180079	475	DN 65	3 x 400 V ~ <sup>1</sup>	2,7	3,00	4,00	-	6,8		16,8		16,7	16,3	15,7	14,9	13,7	12,4	11,0	9,3								166
DCM-G 65-2380/A/BAQE/4	60180080	475	DN 65	3 x 400 V ~ <sup>1</sup>	4,3	4,00	5,50	-	8,2		23,8		23,9	23,5	22,8	21,8	20,3	18,6	16,8	14,5								188

MODEL	CODE	CENTRE DISTANCE	PUMP COUPLINGS	ELECTRICAL DATA							HYDRAULIC DATA															WEIGHT KG			
				VOLTAGE 50 Hz	P1 MAX kW	P2 NOMINAL kW	HP	In (A)		Q=m³/h																			
								230	400		Q=l/min	0	12	18	24	30	36	42	48	54	60	66	72	78	84		90	102	
DCM-G 80-550/A/BAQE/0,55	60162126	360	DN 80	3x230-400V ~	0,8	0,55	0,75	2,6	1,5	H (m)	5,5	5,1	4,7	4,1	3,4	2,6	1,9	1,1										126	
DCM-G 80-650/A/BAQE/0,75	60180082	360	DN 80	3x230-400V ~	1,2	0,75	1,00	3,1	1,8		6,5	6,2	5,8	5,2	4,5	3,7	2,9	2,1											116
DCM-G 80-740/A/BAQE/1,1	60180083	440	DN 80	3x230-400V ~	1,5	1,10	1,50	4,3	2,5		7,1		6,8	6,3	5,9	5,1	4,3	3,5	2,5										178
DCM-G 80-890/A/BAQE/1,5	60180084	440	DN 80	3x230-400V ~	2,0	1,50	2,00	6,2	3,6		8,5		8,3	8,0	7,5	6,8	6,1	5,3	4,4	3,5									179
DCM-G 80-1050/A/BAQE/2,2	60180085	440	DN 80	3x230-400V ~	2,4	2,20	3,00	10,2	5,9		10,1		10,1	9,9	9,5	9,0	8,4	7,7	6,9			3,8							203
DCM-G 80-1530/A/BAQE/3	60180086	500	DN 80	3 x 400 V ~ <sup>1</sup>	3,6	3,00	4,00	-	6,8		14,4		14,1	13,7	13,0	12,2	11,3	10,2	9,2	8,0	6,8								211
DCM-G 80-1700/A/BAQE/4	60180087	500	DN 80	3 x 400 V ~ <sup>1</sup>	3,9	4,00	5,50	-	8,2		16,0		15,7	15,5	15,3	14,6	14,0	13,2	12,3	11,2	10,0	8,9	7,7						232
DCM-G 80-2410/A/BAQE/5,5	60180088	620	DN 80	3 x 400 V ~ <sup>1</sup>	6,5	5,50	7,50	-	10,6		24,1				23,3	22,7	22,0	21,1	20,2	18,9	17,6	16,2							447
DCM-G 80-2700/A/BAQE/7,5	60167327	620	DN 80	3 x 400 V ~ <sup>1</sup>	8,7	7,50	10,00	-	14,4		27,0				26,1	26,1	25,5	24,9	24,2	23,2	22,1	20,7	19,3	17,9					468
DCM-G 80-3420/A/BAQE/11	60167328	620	DN 80	3 x 400 V ~ <sup>1</sup>	12,7	11,00	15,00	-	22,4		34,2				33,3	33,3	32,9	32,3	31,8	30,9	29,9	29,0	27,8	24,4	22,0				502

<sup>1</sup> Star (Λ) starting is possible  
Blank counterflange supplied as standard for twin version

BT BU  
D+CONNECT  
COMMAND AND CONTROL SYSTEMS  
CIRCULATORS AND IN-LINE PUMPS  
MULTISTAGE CENTRIFUGAL AND SELF-PRIMING PUMPS  
SWIMMING POOL, POND AND SALT WATER PUMPS  
CENTRIFUGAL PUMPS  
SUBMERSIBLE PUMPS  
SUBMERSIBLE PUMPS AND SUBMERSIBLE MOTORS  
PRESSURE UNITS



# CP / CP-G / DCP / DCP-G - 2 POLES

IN-LINE PUMPS



Circulating pumps with in-line connections, suitable for civil and industrial installations for heating, air-conditioning and hot water for domestic use. Pump body and motor support in cast iron. PN 16 flanged suction and delivery connections with threaded holes for control pressure gauges. Technopolymer impeller and carbon/ceramic mechanical seal. Three-phase, two-pole, asynchronous motor with external ventilation. To protect the motor it is advisable to use a thermal overload protection complying with the regulations in force.

### Operating range

from 3,6 to 420 m<sup>3</sup>/h with head up to 102 metres.

### Liquid temperature range

from -10°C to +140°C.

**Pumped liquid characteristics** clean, free from solids or abrasive substances, not viscous, not aggressive, not crystallised and chemically neutral.

**Maximum ambient temperature** +40°C

**Maximum working pressure** 16 bar (1600 kPa).

**Protection level** IP 55

**Insulation class** F

PN 16 counter flanges on request.

IE3 ≥ 0,75 kW

ACCESSORIES  
PAG. 79

## CP / CP-G SINGLE WITH OVAL FLANGES

MODEL	CODE	CENTRE DISTANCE	PUMP COUPLINGS	ELECTRICAL DATA						HYDRAULIC DATA										WEIGHT KG												
				VOLTAGE 50 Hz	P1 MAX kW	P2 NOMINAL		In (A)		Q=m <sup>3</sup> /h	0	3,6	4,8	6	12	18	24	30	36		Q=l/min	0	60	80	100	200	300	400	500	600		
CP 40/1900 T	60179895	390	DN 40	3 x 230 - 400 V ~	1,1	0,75	1	4,3	2,5	H (m)	17,6	17,6	17,4	17	14																41	
CP 40/2300 T	60179889	390	DN 40	3 x 230 - 400 V ~	1,45	1,1	1,5	5,2	3		21,8	21,8	21,3	21	18																	41
CP 40/2700 T	60179896	390	DN 40	3 x 230 - 400 V ~	1,89	1,5	2	6,4	3,7		26,9	26,9	26,7	26,2	23,2																	40
CP 40/3500 T	60180101	390	DN 40	3 x 230 - 400 V ~	2,53	2,2	3	8,6	5		34,8	34,9	34,7	34,2	31,7																	44
CP 40/3800 T	60180102	320	DN 40	3 x 230 - 400 V ~	3,54	3	4	3	4					38	35	30																37
CP 40/4700 T	60180103	380	DN 40	3 x 230 - 400 V ~	4,87	4	5,5	4	5,5					47	44	39,5	35															50
CP 40/5500 T	60180104	380	DN 40	3 x 400 V ~ <sup>1</sup>	6,57	5,5	7,5	-	10,6					55	53	48	42														55	
CP 40/6200 T	60167345	380	DN 40	3 x 400 V ~ <sup>1</sup>	9,18	7,5	10	-	14,4					62	59	54	49														56	
CP 50/2200 T	60179897	425	DN 50	3 x 230 - 400 V ~	1,42	1,1	1,5	5,4	3,1					20	16,5	11															38,6	
CP 50/2600 T	60179892	425	DN 50	3 x 230 - 400 V ~	1,89	1,5	2	6,5	3,8					25	22	16															39	
CP 50/3100 T	60179891	425	DN 50	3 x 230 - 400 V ~	2,51	2,2	3	8,6	5					31	28,5	24															36	
CP 50/4100 T	60179893	425	DN 50	3 x 230 - 400 V ~	3,8	4	5,5	13,5	7,8					40,7	38,5	34,5	27,7														36	
CP 50/4600 T	60180107	400	DN 50	3 x 400 V ~ <sup>1</sup>	6,57	5,5	7,5	-	10,6							44	41,5	37	31												46,0	
CP 50/5100 T	60167346	400	DN 50	3 x 400 V ~ <sup>1</sup>	9,18	7,5	10	-	14,4							50	47,5	42,5	37												46,1	
CP 50/5650 T	60167347	400	DN 50	3 x 400 V ~ <sup>1</sup>	9,18	7,5	10	-	14,4							55,5	53	49	44												57,9	

<sup>1</sup> Star (A) starting is possible



# CP / CP-G / DCP / DCP-G - 2 POLES

IN-LINE PUMPS



## CP-G SINGLE WITH OVAL FLANGES

MODEL	CODE	CENTRE DISTANCE	PUMP COUPLINGS	ELECTRICAL DATA				HYDRAULIC DATA																	WEIGHT KG				
				VOLTAGE 50 Hz	P1 MAX kW	P2 NOMINAL kW	In (A)	Q=m³h	0	36	42	48	54	60	66	72	78	84	90	102	114	120	150	180		210	240	270	
CP-G 100-1600/A/BAQE/4	1D6111G8V	500	DN 100	3 x 400 V ~ 1	5,3	4	5,5	8,2	Q=l/min	0	600	700	800	900	1000	1100	1200	1300	1400	1500	1700	1900	2000	2500	3000	3500	4000	4500	64
CP-G 100-1950/A/BAQE/5,5	1D6111G9V	500	DN 100	3 x 400 V ~ 1	7	5,5	7,5	10,2	H (m)	16	15	14,6	14,2	13,7	13,3	12,8	12,3	11,7	11	10	9,3	8							102
CP-G 100-2350/A/BAQE/7,5	1D6111GAV	500	DN 100	3 x 400 V ~ 1	9,2	7,5	10	14,4		23,5	23,1	23	22,8	22,6	22,5	22	21,6	21,1	20,7	20,2	19	17,5	14,8	12					89
CP-G 100-2400/A/BAQE/11	1D6211GBV	550	DN 100	3 x 400 V ~ 1	13,9	11	15	19,9		24									22	21,4	20,4	20	17,4	16,8	12				127
CP-G 100-3050/A/BAQE/15	1D6211GCV	550	DN 100	3 x 400 V ~ 1	16,9	15	20	26,8		30,5									29	28,4	27,5	27	24,5	21,3	18,3				150
CP-G 100-3550/A/BAQE/18,5	1D6211GDV	550	DN 100	3 x 400 V ~ 1	21,9	18,5	25	33		35,5									34,3	33,6	32,6	32,3	29,8	26,8	23,6	20			146
CP-G 100-3850/A/BAQE/22	1D6211GEV	550	DN 100	3 x 400 V ~ 1	26,5	22	30	38,1		38,5									37,2	36,8	36	35,8	33,5	30,8	27,5	24			259
CP-G 100-4800/A/BAQE/30	1D6311GFV	550	DN 100	3 x 400 V ~ 1	39,2	30	40	52,1		48									48,5	48,2	47,5	47	44,7	41	36	29			337
CP-G 100-5600/A/BAQE/37	1D6311GGV	550	DN 100	3 x 400 V ~ 1	45	37	50	62,6		56									58	57,5	57,2	57	55	52	48	43			397
CP-G 100-6300/A/BAQE/45	1D6311GHV	550	DN 100	3 x 400 V ~ 1	55,9	45	60	78,4		63									65,5	65	64	63	61,9	58,9	55,5	50,6	44,2		470
CP-G 100-8300/A/BAQE/55	1D6411GKV	670	DN 100	3 x 400 V ~ 1	70,1	55	75	94,6		83									83,7	83,7	83,7	83,2	80,7	77,3	72,8	66,4	59,5		627

MODEL	CODE	CENTRE DISTANCE	PUMP COUPLINGS	ELECTRICAL DATA				HYDRAULIC DATA														WEIGHT KG					
				VOLTAGE 50 Hz	P1 MAX kW	P2 NOMINAL kW	In (A)	Q=m³h	0	90	102	114	120	150	180	210	240	270	300	330	360		390	420			
CP-G 125-4750/A/BAQE/37	1D7311GGV	620	DN 125	3 x 400 V ~ 1	44,7	37	50	62,6	Q=l/min	0	1500	1700	1900	2000	2500	3000	3500	4000	4500	5000	5500	6000	6500	7000	444		
CP-G 125-5300/A/BAQE/45	1D7311GHV	620	DN 125	3 x 400 V ~ 1	53,9	45	60	78,4	H (m)	46,5					45	44	42	39	37	34,5	31	28					507
CP-G 125-5800/A/BAQE/55	1D7311GKV	620	DN 125	3 x 400 V ~ 1	68,2	55	75	94,6		57,5					57	56	55	53	51	49	46	43	39	36			539

<sup>1</sup> Star (A) starting is possible

## DCP TWIN FLANGES

MODEL	CODE	CENTRE DISTANCE	PUMP COUPLINGS	ELECTRICAL DATA				HYDRAULIC DATA												WEIGHT KG								
				VOLTAGE 50 Hz	P1 MAX kW	P2 NOMINAL kW	In (A)	Q=m³h	6	7,5	9	10,5	12	13,5	15	18	21	24	27		30	36						
DCP 40/1250 T	60180108	340	DN 40	3 x 230 - 400 V ~	0,83	0,75	1	2,9	1,7	H (m)	12,5	11,5	10,5	9,5	8,1	6,8	5,2											50
DCP 40/1650 T	60180109	340	DN 40	3 x 230 - 400 V ~	1,05	0,75	1	2,9	1,7		16,5	15,5	14,5	13,5	12,3	11	9,5	6										50
DCP 40/2050 T	60180110	340	DN 40	3 x 230 - 400 V ~	1,33	1,1	1,5	4,3	2,5		20,5	20	19	18	17	16	15	11,5	7,5									52
DCP 40/2450 T	60180111	340	DN 40	3 x 230 - 400 V ~	2,07	1,5	2	5,9	3,4		24,5	24	23,5	23	22	21	20	16,5	13									54
DCP 50/1550 T	60180112	365	DN 50	3 x 230 - 400 V ~	2,07	1,5	2	5,9	3,4								15,5	15	14,1	13	11,8	10,5	7				56	
DCP 50/1900 T	60180113	365	DN 50	3 x 230 - 400 V ~	2,53	2	2,7	8	4,6								19	18,5	17,5	16,5	15,5	14,5	10,5				58	
DCP 50/2450 T	60180114	365	DN 50	3 x 230 - 400 V ~	3,54	3	4	10,2	5,9								24,5	24	23,5	23	22	20,5	17				66	
DCP 50/3000 T	60180115	365	DN 50	3 x 230 - 400 V ~	3,54	3	4	10,2	5,9								30	29	28	26,5	25	23	18				56	
DCP 50/3650 T	60180116	410	DN 50	3 x 230 - 400 V ~	4,87	4	5,5	13,5	7,8								36,5	35,5	34,5	33,5	32,5	31	27				86	



# K-HA

## CENTRIFUGAL PRESSURE BOOSTING PUMPS



K-HA single impeller centrifugal pump is designed for water pressure boosting in households, flats (domestic properties) to provide additional pressure to hot and cold water taps and similar outlet points. K-HA centrifugal pump is mainly for use in open vented systems (tanks), but may also be installed directly on the incoming water mains supply to feed a boiler, provided approval has been obtained from the local Water Company. The pump is supplied with a 0,3 meter power cable.

### Operating range

up to 4,2 m<sup>3</sup>/h with head up to 22m.

**Liquid quality requirements** clean, free from solids or abrasive substances, non viscous, non aggressive, non crystallized, chemically neutral, close to the characteristics of water.

**Liquid temperature range** from 0°C to +100 °C

**Ambient temperature** from -10°C to +55 °C

**Environment humidity** ≤ 95%

### Maximum operating pressure

4 bar (35° C liquid temperature)

2 bar (65° C liquid temperature)

**Minimum automatic (flow switch) operating pressure** 0,5 mwc

**Minimum automatic (flow switch) operating flow** 2,5 l/min

# K-HA

MODEL	CODE	VOLTAGE 50 Hz	P1 MAX KW	P2 NOMINAL		In A	Ist A	cos φ	CONDENSATEUR (ηF)	HOSE DIAMETER (mm)	MAXIMUM FLOW RATE (m <sup>3</sup> /h)	MAXIMUM HEAD (m)	WEIGHT (kg)
				KW	HP								
K 20/9 HA	60161484	220 V	0,18	0,03	0,12	0,82	2,89	0,926	8	ø 16 mm	2,10	9	5,4
K 30/12 HA	60161483	220 V	0,28	0,12	0,16	1,28	4,09	0,969	8	ø 16 mm	2,40	12	7,9
K 30/15 HA	60161482	220 V	0,34	0,18	0,25	1,5	4,09	0,98	8	ø 16 mm	3,00	15	7,9
K 40/19 HA	60161481	220 V	0,47	0,25	0,34	2,25	7,6	0,905	8	ø 16 mm	3,60	18	8,9
K 40/22 HA	60160878	220 V	0,57	0,37	0,5	2,54	7,6	0,932	8	ø 16 mm	4,20	22	8,9











# CIRCULATORS AND IN-LINE PUMPS ACCESSORIES

---

# ACCESSORIES

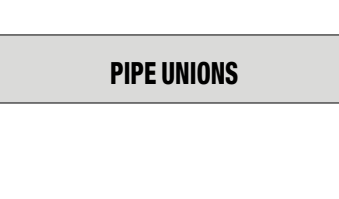
## CIRCULATORS AND IN-LINE PUMPS

UNION KIT	DESCRIPTION	CODE	MODEL	WEIGHT Kg	Q.TY X BOX
 <p><b>1/2" F UNION KIT</b></p>	1/2" F UNION KIT	60110426	EVOSTA 2 40-70/130-1/2	0,4	24
			EVOSTA 3 40/130 1/2 - 60/130 1/2 - 80/130 1/2		
			EVOSTA 2 20-75/130 SOL (1/2") - EVOSTA 2 20-105/130 (1/2") - EVOSTA 2 30-145/130 SOL (1/2")		
			VSA 35/130-1/2" - 55/130-1/2" - 65/130-1/2"		
 <p><b>3/4" F UNION KIT</b></p>	3/4" F UNION KIT	547121050	EVOSTA 2 40-70/130 - EVOSTA 2 40-70/180	0,4	24
			EVOSTA 3 40/130 - 60/130 - 80/130 EVOSTA 3 40/180 - 60/180 - 80/180		
			EVOSTA 2 20-75/130 SOL - EVOSTA 2 20-105/130 - EVOSTA 2 30-145/130 SOL - EVOSTA 2 20-75/180 SOL - EVOSTA 2 20-105/180 - EVOSTA 2 30-145/180 SOL		
			EVOPLUS 40/180 - 60/180 - 80/180 - 110/180		
			VSA 35/130 - 55/130 - 65/130 VSA 35/180 - 55/180 - 65/180		
 <p><b>1" F UNION KIT</b></p>	1" F UNION KIT	547121060	EVOSTA 2 40-70/130 - EVOSTA 2 40-70/180	0,4	24
			EVOSTA 3 40/130 - 60/130 - 80/130 EVOSTA 3 40/180 - 60/180 - 80/180		
			EVOSTA 2 20-75/130 SOL - EVOSTA 2 20-105/130 - EVOSTA 2 30-145/130 SOL - EVOSTA 2 20-75/180 SOL - EVOSTA 2 20-105/180 - EVOSTA 2 30-145/180 SOL		
			EVOPLUS 40/180 - 60/180 - 80/180 - 110/180		
			VSA 35/130 - 55/130 - 65/130 VSA 35/180 - 55/180 - 65/180		
 <p><b>1 1/4" F UNION KIT</b></p>	1 1/4" F UNION KIT	547121070	EVOSTA 3 40/180 X - 60/180 X - 80/180 X	0,7	24
			EVOPLUS 40/180 X - 60/180 X - 80/180 X - 110/180 X		
			EVOPLUS 40/180 X - 60/180 X - 80/180 X - 110/180 X		
			ALME - ALPE		
			ALM 500 - ALP 2000		
 <p><b>1 1/4" M UNION KIT</b></p>	1 1/4" M UNION KIT	547121080	EVOSTA 2 40-70/130 EVOSTA 2 40-70/180	0,4	24
			EVOSTA 3 40/130 - 60/130 - 80/130 EVOSTA 3 40/180 - 60/180 - 80/180		
			EVOPLUS 40/180 - 60/180 - 80/180 - 110/180		

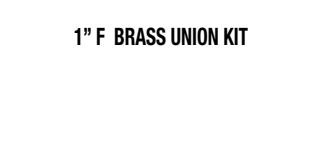
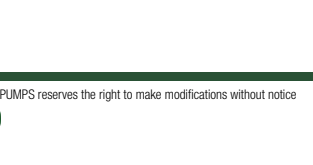
PIPE UNIONS	DESCRIPTION	CODE	MODEL	WEIGHT Kg	Q.TY X BOX
 <p><b>1/2" F BRASS UNION KIT</b></p>	1/2" F BRASS UNION KIT	547121120	EVOSTA 2 SAN EVOPLUS SMALL SAN	0,4	24
			VS 8/150 - 16/150 - 35/150 - 65/150		
			ALM 200 - 800		
 <p><b>3/4" F BRASS UNION KIT</b></p>	3/4" F BRASS UNION KIT	547121130	EVOSTA 2 SAN EVOPLUS SMALL SAN	0,4	24
			VS 8/150 - 16/150 - 35/150 - 65/150		
			ALM 200 - 800		
 <p><b>1" F BRASS UNION KIT</b></p>	1" F BRASS UNION KIT	547121140	EVOSTA 2 SAN EVOPLUS SMALL SAN	0,4	24
			VS 8/150 - 16/150 - 35/150 - 65/150		
			ALM 200 - 800		



# ACCESSORIES

## CIRCULATORS AND IN-LINE PUMPS

COPPER KIT UNIONS	DESCRIPTION	CODE	MODEL	WEIGHT Kg
 <p>COPPER UNION KIT TO SOLDER Ø 22</p>	COPPER UNION KIT TO SOLDER Ø 22	547121150	EVOSTA 2 SAN EVOPLUS SMALL SAN	0,4
			VS 8/150 - 16/150 - 35/150 - 65/150	
	ALM 200 - 800			
	COPPER UNION KIT TO SOLDER Ø 28	547121160	EVOSTA 2 SAN EVOPLUS SMALL SAN	0,4
VS 8/150 - 16/150 - 35/150 - 65/150				
ALM 200 - 800				

REDUCTION KIT	DESCRIPTION	CODE	MODEL	WEIGHT Kg
 <p>2" - 1" ½ REDUCTION KIT</p>	2" - 1" ½ REDUCTION KIT	547121170	EVOSTA 2 40-70/130 EVOSTA 2 40-70/180	0,1
			EVOSTA 3 40/130 - 60/130 - 80/130 EVOSTA 3 40/180 - 60/180 - 80/180	
			EVOPLUS 40/180 - 60/180 - 80/180 - 110/180	
			VA	

INSULATION HOUSING KIT	DESCRIPTION	CODE	MODEL	WEIGHT Kg
	INSULATION HOUSING KIT *	60189434	EVOSTA 2 (all models)	0,6
			EVOSTA 3 (all models) * supplied as standard in the standar version	
	INSULATION HOUSING KIT	60147096	VSA 130 - 150 - 180	0,6
			VS 130 - 150 - 180	
			VA 130-150-180 mm. inter	

POWER CONNECTOR	DESCRIPTION	CODE	MODEL	WEIGHT Kg
	EVOPLUS POWER CONNECTOR	60152234	EVOPLUS SMALL (tutti i modelli)	0,1
	EVOSTA 3 ANGULAR CONNECTOR	60192429	EVOSTA 3	0,1

# ACCESSORIES

CIRCULATORS AND IN-LINE PUMPS

REMOTE CONTROL MODULE	DESCRIPTION	CODE	MODEL	WEIGHT Kg
 <b>EVOPLUS SMALL MULTI-FUNCTION MODULE</b>	<b>EVOPLUS SMALL BASIC MODULE</b>	60152883	EVOPLUS SMALL (All models) EVOPLUS SMALL SAN (All models)	0,5
	<b>EVOPLUS SMALL MULTI-FUNCTION MODULE</b>	60152884	EVOPLUS SMALL (All models) EVOPLUS SMALL SAN (All models) Supplied with EvoPlus Small Twin models	0,5
	<b>LON/MOD BUS CONVERTER MODULE</b>	60162338	EVOPLUS SMALL (All models) EVOPLUS (All models)	0,5

## BASIC MODULE

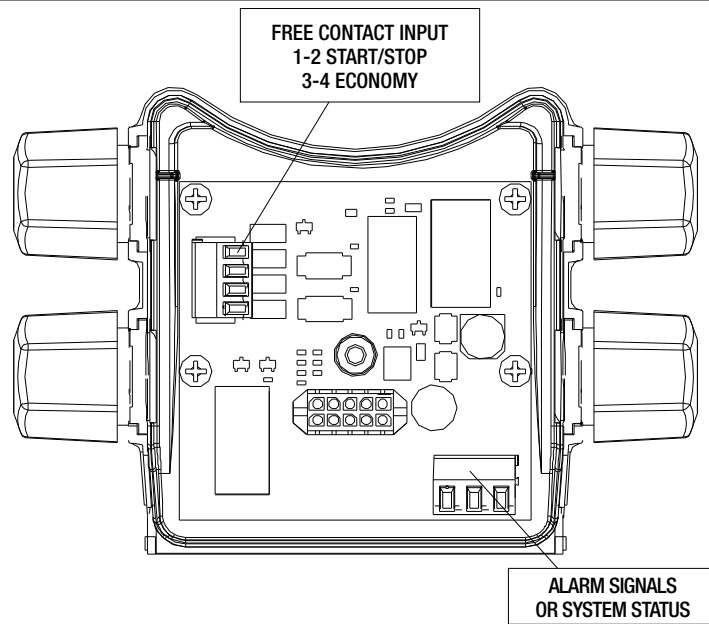

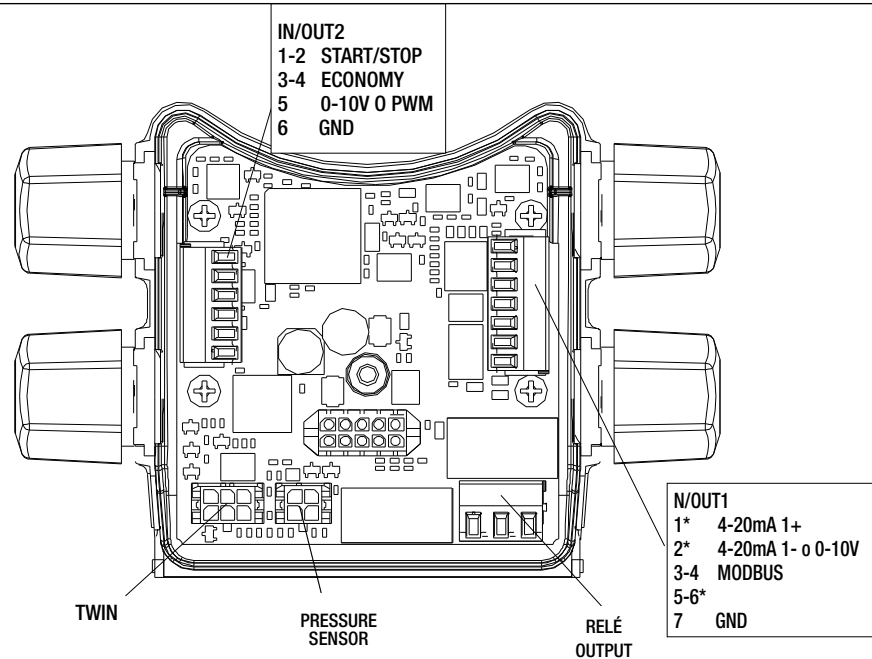

## MULTI-FUNCTION MODULE



# ACCESSORIES

## CIRCULATORS AND IN-LINE PUMPS

FLANGE KIT*	DESCRIPTION	CODE	MODEL	WEIGHT Kg
 <p><b>FLANGE KIT DN 10 PN 10</b></p>	<b>PN 10 DN 32 FLANGE KIT</b>	60153288	EVOPLUS SMALL (All models) EVOPLUS (All models)	4,7
	<b>DN 32 PN 10 AISI 304 FLANGE KIT</b>	60153296	EVOPLUS SMALL SAN (All models) EVOPLUS SAN (All models)	4,7
	<b>DN 40 PN 10 FLANGE KIT</b>	547121400	EVOPLUS SMALL (All models) EVOPLUS (All models) KLPE 40/600 - DKLPE 40/60 KLPE 40/1200 - DKLPE 40/1200 KLM 40/300 - DKLM 40/300 KLP 40/600 - DKLP 40/600 KLP 40/900 - DKLP 40/900 KLP 40/1200 - DKLP 40/1200 B 50/250.40 - B 56/250.40 - B 80/250.40 D 50/250.40 - D 56/250.40 - D 80/250.40 BMH-BPH WITH PUMP COUPLINGS DN 40	2,4
	<b>DN 40 PN 10 AISI 304 FLANGE KIT</b>	60153297	EVOPLUS SMALL SAN (All models) EVOPLUS SAN (All models)	2,5
	<b>DN 50 PN 10 FLANGE KIT</b>	547121410	EVOPLUS (All models) KLME50/600 - DKLME 50/600 KLPE 50/1200 - DKLPE 50/1200 KLM 50/300 - DKLM 50/300 KLM 50/600 - DKLM 50/600 KLP 50/900 - DKLP 50/900 KLP 50/1200 - DKLP 50/1200 BMH-BPH WITH PUMP COUPLINGS DN 40	3,2
	<b>DN 50 PN 10 AISI 304 FLANGE KIT</b>	60153298	EVOPLUS SAN (All models)	3
	<b>DN 65 PN 10 FLANGE KIT</b>	547121420	EVOPLUS (All models) KLME 65/600 - DKLME 65/600 KLPE 65/1200 - DKLPE 65/1200 KLM 65/300 - DKLM 65/300 KLM 65/600 - DKLM 65/600 KLP 65/900 - DKLP 65/900 KLP 65/1200 - DKLP 65/1200 BMH-BPH WITH PUMP COUPLINGS DN 40	4,0
	<b>DN 65 PN 10 AISI 304 FLANGE KIT</b>	60153299	EVOPLUS SAN (All models)	4
	<b>DN 80 PN 10 FLANGE KIT</b>	547121430	EVOPLUS (All models) BPH - DPH (All models) KLME 80/600 - DKLME 80/600 KLPE 80/1200 - DKLPE 80/1200 KLM 80/300 - DKLM 80/300 KLM 80/600 - DKLM 80/600 KLP 80/900 - DKLP 80/900 KLP 80/1200 - DKLP 80/1200 BMH-BPH WITH PUMP COUPLINGS DN 40	4,8
	<b>DN 100 PN 10 FLANGE KIT</b>	60153289	EVOPLUS (All models)	4,3
 <p><b>FLANGE KIT DN 80 PN 16</b></p>	<b>DN 40 - PN 16 FLANGE KIT</b>	109620040	CME 40 - CPE 40 - CM - CP 40	5,3
	<b>DN 50 - PN 16 FLANGE KIT</b>	109620050	CME 50 - CPE 50 - CM - CP 50	6,3
	<b>DN 65 - PN 16 FLANGE KIT</b>	109620060	CME 65 - CM-GE 65 - CP-GE 65 - CM 65 - CP 65	7,5
	<b>DN 80 PN 16 FLANGE KIT</b>	109620080	EVOPLUS (All models) CM-GE 80 - CP-GE 80 - CM 80 - CP 80	9,5
	<b>DN 100 PN 16 FLANGE KIT</b>	109620100	EVOPLUS (All models) CM-GE 100 - CP-GE 100 - CM 100 - CP 100	10,9
	<b>DN 125 - PN 16 FLANGE KIT</b>	109620120	CM-GE 125 - CP-GE 125 - CM 125 - CP 125	14,5
	<b>DN 150 - PN 16 FLANGE KIT</b>	109620150	CM-GE 150 - CP-GE 150 - CM 150 - CP 150	18,6

\* The counterflange kit comprises: two counterflanges, nuts and bolts.

# ACCESSORIES

## CIRCULATORS AND IN-LINE PUMPS

BLANK FLANGE KIT	DESCRIPTION	CODE	MODEL	WEIGHT Kg
	BLANK FLANGE KIT	561000590	(STD. FEATURE IN THE TWIN VERSION)	-
	DN 40 BLANK FLANGE KIT	161050160	BMH-BPH (STD. FEATURE IN THE TWIN VERSION)	-
	BLANK FLANGE KIT	161050170	BMH-BPH (STD. FEATURE IN THE TWIN VERSION)	-
	DN32 PN 10 BLANK FLANGE KIT - EVOPLUS S (STD. FEATURE IN THE TWIN VERSION)	60153741	EVOPLUS SMALL	4,7
	DN 32 PN 10 AISI 304 BLANK FLANGE KIT - EVOPLUS M&L (STD. FEATURE IN THE TWIN VERSION)	60164747	EVOPLUS MEDIUM & LARGE SAN	4,7

COMPENSATION KIT (FOR EVOPLUS)	DESCRIPTION	CODE	MODEL	WEIGHT Kg
 <p>COMPENSATION KIT</p>	COMPENSATION KIT FOR DN40 (30MM)	60153181	EVOPLUS (all models DN40)	2,5
	COMPENSATION KIT FOR DN50 (40MM)	60153182	EVOPLUS (all models DN50)	3,3



## COMPENSATION KIT

AVAILABLE ON REQUEST, COMPENSATION KIT, USED TO COMPENSATE THE CENTRE DISTANCE DIFFERENCE BETWEEN OLD AND NEW MODELS.

DESCRIPTION	CODE	CM old MODEL		CM new MODEL		LENGHT
		DN	CENTRE DISTANCE	DN	CENTRE DISTANCE	
KIT N° 1	147121520	65	475	65	360	115
KIT N° 2	147121530				360	165
KIT N° 3	147121540	80	525	80	440	85
KIT N° 4	147121550				500	25
KIT N° 5	147121560		550		500	50
KIT N° 6	147121570	100	630	100	550	80

# ACCESSORIES

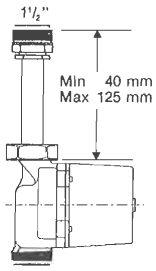
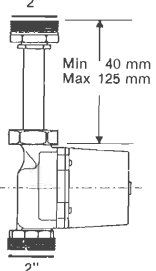
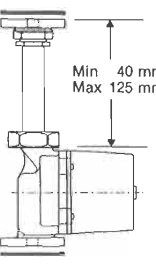
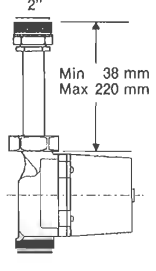
## CIRCULATORS AND IN-LINE PUMPS

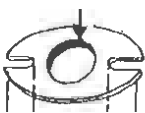
"QUICK SERVICE" ADAPTION KIT	DESCRIPTION	CODE	MODEL
	<b>ADAPTATION KIT A - 1 1/2" EXTENSION</b>	547121300	EVOSTA 2 40-70/130 - EVOSTA 2 40-70/180 EVOSTA 3 40/130 - EVOSTA 3 60/130 - EVOSTA 3 80/130 EVOSTA 3 40/180 - EVOSTA 3 60/180 - EVOSTA 3 80/180 VA 25/130 - VA 25/180 - VA 35/130 - VA 35/180 - VA 55/130 - VA 55/180 - VA 65/130 - VA 65/180
	<b>ADAPTATION KIT B - CONVERSION FROM 1 1/2" TO 2"</b>	547121310	EVOSTA 2 40-70/130 - EVOSTA 2 40-70/180 EVOSTA 3 40/130 - EVOSTA 3 60/130 - EVOSTA 3 80/130 EVOSTA 3 40/180 - EVOSTA 3 60/180 - EVOSTA 3 80/180 VA 25/130 - VA 25/180 - VA 35/130 - VA 35/180 - VA 55/130 - VA 55/180 - VA 65/130 - VA 65/180
	<b>ADAPTATION KIT C - CONV. FROM 1 1/2" UNION TO DN 25 - DN 32 FL.</b>	547121320	EVOSTA 2 40-70/130 - EVOSTA 2 40-70/180 EVOSTA 3 40/130 - EVOSTA 3 60/130 - EVOSTA 3 80/130 EVOSTA 3 40/180 - EVOSTA 3 60/180 - EVOSTA 3 80/180
	<b>ADAPTATION KIT D - 2" EXTENSION</b>	547121330	EVOSTA 3 40/180X - EVOSTA 3 60/180X - EVOSTA 3 80/180X VA 25/180 X - VA 35/180 X - VA 55/180 X - VA 65/180 X
	<b>ADAPTATION KIT E - 2" BRASS ADAPTER</b>	547121340	EVOSTA 3 40/180X - EVOSTA 3 60/180X - EVOSTA 3 80/180X VA 25/130 - VA 25/180 - VA 35/130 - VA 35/180 - VA 55/130 - VA 55/180 - VA 65/130 - VA 65/180 VA 25/180X - VA 35/180X - VA 55/180X - VA 65/180X
	<b>ADAPTATION KIT E - 1 1/2" BRASS ADAPTER</b>	547121350	EVOSTA 2 40-70/130 - EVOSTA 2 40-70/180 EVOSTA 3 40/130 - EVOSTA 3 60/130 - EVOSTA 3 80/130 EVOSTA 3 40/180 - EVOSTA 3 60/180 - EVOSTA 3 80/180
	<b>OVAL ADAP. KIT - DN 40</b>	547121260	EVOSTA 2 40-70/130 - EVOSTA 2 40-70/180 EVOSTA 3 40/130 - EVOSTA 3 60/130 - EVOSTA 3 80/130 EVOSTA 3 40/180 - EVOSTA 3 60/180 - EVOSTA 3 80/180
	<b>OVAL FLANGE KIT - DN 50</b>	547121270	EVOSTA 3 40/180X - EVOSTA 3 60/180X - EVOSTA 3 80/180X VA 25/180X - VA 35/180X - VA 55/180X - VA 65/180X

# EBOX

PROTECTION AND CONTROL SYSTEMS



EBOX basic

**EBOX plus** is an electronic control panel for the protection and automatic operation of one or two submersible pumps or pressurizing both single-phase and three-phase, installed in domestic, civil and industrial environments.

**EBOX basic** is an electronic control panel for the protection and automatic operation of one or two electronic submersible pumps or single-phase pressurization for domestic applications.

**Nominal tension of power supply**

**EBOX plus** 1x 230 V / 3 x 230 V - 3 x 400 V (automatic selection)

**EBOX basic** 1x 230 V

**Frequency** 50 - 60 Hz

**Maximum use of power**

**EBOX plus** 5,5 kWatt + 5,5 kWatt

**EBOX basic** 2,2 kWatt + 2,2 kWatt

**Maximum use of current** 12 A + 12 A

**Starting capacitor**

KIT supplied as an accessory

**Limits of use ambient temperature**

-10° C + 40° C

**Limits of storage temperature**

-25° C + 55° C

**Relative humidity to the air** 90% a 20° C

**Max altitude max** 1000 s.l.m.

**Degree of protection** IP 55

Reference standard for the construction of the panels EN 60335-1

ebox

MODEL	CODE	VOLTAGE 50 HZ	STARTING	P2 NOMINAL		MAX CURRENT A	TO BE USED FOR:
				kW x2	HP x2		
<b>EBOX BASIC 230/50-60</b>	60163214	1 X 230 V	DIRECT	2,2	3	12+12	DKLM-DKLP single-phase
<b>EBOX PLUS 230-400V/50-60</b>	60163215	1 X 230 V	DIRECT	2,2	3	12+12	DKLM-DLP single-phase
		3 X 230 V		3	4		DKLM-DKLP three-phase
		3 X 400 V		5,5	7,5		DCM three-phase 400V

D+CONNECT

COMMAND AND CONTROL SYSTEMS

CIRCULATORS AND IN-LINE PUMPS

MULTISTAGE CENTRIFUGAL AND SELF-PRIMING PUMPS

SWIMMING POOL, POND AND SALT WATER PUMPS

CENTRIFUGAL PUMPS

SUBMERSIBLE PUMPS

SUBMERSIBLE PUMPS AND SUBMERSIBLE MOTORS

PRESSURE UNITS





exemplative photo

Supplied on the box in self-extinguishing thermoplastic material, complete with brackets for wall mounting. The framework is self-protected and protects the pump from overload, short circuits with manual reset.

Complete with:

- Power line switch with pad lockable door handle (except in single-phase version)
- Self-protected transformer for the power supply of the external controls
- Terminals for connecting the electric pump and the float / pressure control switches
- Terminals without potential for controlling alarm and remote installation of an audible / visual alarm
- Button on the front panel for manual operation (single phase versions)
- Switch on the front panel for manual operation - 0 - Automatic
- Amperometric protection reports
- Pump running indicator
- Voltage indicator
- Limits of use ambient temperature: -10° C +40° C
- Degree of protection IP55

**Ambient temperature operation limits**

-10 °C +40 °C.

**Protection class** IP55.

MODEL	CODE	VOLTAGE 50 HZ	STARTING	P2 NOMINAL		MAX CURRENT A	TO BE USED FOR
				KW x2	HP x2		
ED0,1M	60169998	1X220 - 240 V~	DIRECT	0,1	0,1	1	ALM 200 M
ED0,08T	60170013	3X400 V~	DIRECT	0,1	0,08	1	ALM 200 T, ALM 500 T, ALP 800 T, KLM 40/300 T, KLM 50/300 T, KLM 50/600 T, KLM 65/300 T, KLM 65/600 T, KLM 80/300 T
ED0,3M	60170001	1X220 - 240 V~	DIRECT	0,2	0,3	2	ALM 500 M, ALP 800 M, KLM 40/300 M
ED0,5T	60170015	3X400 V~	DIRECT	0,4	0,5	2	ALP 2000 T, CM 40/440 T, CM 40/540 T, CM 40/670 T, CM 40/870 T, CM 50/1000 T, CM 50/1270 T, CM 50/510 T, CM 50/630 T, CM 50/780 T, CM-G 65/420 T, CM-G 65/540 T, KLM 80/600 T, KLP 40/1200 T, KLP 40/600 T, KLP 40/900 T, KLP 50/900 T, CM 40/1300 T, CM-G 65/660 T, CM-G 80/550 T, KLP 50/1200 T
ED0,75M	60170003	1X220 - 240 V~	DIRECT	0,6	0,75	4	KLP 40/600 M
ED1T	108320330	3X400 V~	DIRECT	0,7	1	3	CM 40/1450 T, CM 50/1420 T, CM-G 65/760 T, CM-G 65/920 T, CM-G 80/650 T, KLP 65/900 T, KLP 65/1200 T, KLP 80/900 T
ED1,5T	108320340	3X400 V~	DIRECT	1,1	1,5	4	CM-G 100/510 T, CP 50/2200 T, KLP 80/1200 T
ED2,5T	108320350	3X400 V~	DIRECT	1,8	2,5	6	CM-G 65/1080 T, CM-G 65/1200 T, CM-G 65/1530 T, CM-G 80/740 T, CM-G 80/890 T, CM-G 80/1050 T, CM-G 100/650 T, CM-G 100/660 T, CM-G 100/865 T, CP 40/2300 T, CP 40/2700 T, CP 40/3500 T, CP 40/3800 T, CP 50/2600 T, CP 50/3100 T, CP-G 65/1470 T, CP-G 65/1900 T, CP-G 80/1400 T
ED4T	60170054	3X400 V~	DIRECT	2,9	4	10	CP 50/4100 T, CP 40/4700 T
ED8T	60170055	3X400 V~	diretto	5,9	8	14	CM-G 80-2410 T, CM-G 100-1650 T, CM-G 125-1270 T, CM-G 150-955 T, CP 40/5500 T, CP 50/4600 T, CP-G 65-3400 T, CP-G 80-2400 T, CP-G 100-1950 T

For higher power control panels please contact our sales network



“  
*D.Learning:  
DAB Know-how always at  
your disposal in a  
fun and easy way.*  
”



**EVERYTHING YOU HAVE TO  
KNOW WITH ONE CLICK**

[DLEARNING.DABPUMPS.COM](http://DLEARNING.DABPUMPS.COM)



# INDEX - MULTISTAGE CENTRIFUGAL AND SELF-PRIMING PUMPS



DOWNLOAD  
TECHNICAL CATALOGUE



## JET - JETINOX - JETCOM

SELF-PRIMING CENTRIFUGAL PUMPS

AG AH AI

PAG. 90



## DP

PUMPS FOR DEEP SUCTION

A3

PAG. 93



## GARDENJET - GARDEN INOX - GARDEN COM

SELF-PRIMING CENTRIFUGAL PUMPS

A4

PAG. 94



## EURO - EUROINOX - EUROCOM

MULTISTAGE CENTRIFUGAL PUMPS

AJ AM AL

PAG. 95



## MULTI INOX

SELF-PRIMING HORIZONTAL MULTISTAGE PUMPS

AM

PAG. 97



## JET - JETINOX - EUROINOX M-P

CENTRIFUGAL PUMPS FITTED

AN AO

PAG. 98



## AQUAJET - AQUAJETINOX

SELF-PRIMING AUTOMATIC BOOSTER

A2

PAG. 99



## ACTIVE SYSTEM

ON/OFF AUTOMATIC ELECTRONIC BOOSTER SYSTEMS

A1

PAG. 100



## BOOSTER SILENT

ON/OFF AUTOMATIC ELECTRONIC BOOSTER SYSTEMS

D7

PAG. 101



# ESYLINE

E7

PAG. 102



## NBB

MOUNTING KIT FOR WATER COLLECTION AND PRESSURIZATION

DJ

PAG. 107



## ACTIVE SWITCH

RAIN WATER SYSTEM

A5

PAG. 108



## AQUAPROF

RAIN WATER SYSTEM

A5

PAG. 108



## EBOX

CONTROL PANEL

AT

PAG. 109



## SMART PRESS

ON/OFF CONTROLLER

AR

PAG. 110



## ACCESSORIES

PAG. 111

# JET - JETINOX - JETCOM

## SELF-PRIMING CENTRIFUGAL PUMPS



Self-priming centrifugal pump with excellent suction capacity even when there are air bubbles. Particularly suitable for water supply in domestic installations, small-scale agriculture, gardening and wherever self-priming operation is necessary.

**Jet:** cast iron pump body.

**Jetinox:** stainless steel pump body.

**Jetcom:** technopolymer pump body.

Motor support in cast iron, technopolymer impeller, diffuser, Venturi tube and sand guard. Stainless steel adjustment rings.

Carbon/ceramic mechanical seal. Asynchronous motor closed and cooled by external ventilation. Built-in thermal and current overload protection and a capacitor permanently on in the single-phase version. For the protection of the three-phase motor it is advisable to use a suitable overload protection complying with the regulations in force.

**Operating range** two-poles from 0.4 to 10.5 m<sup>3</sup>/h with head up to 62 metres

**Liquid temperature range**

from 0°C to +35°C for domestic use  
from 0°C to +40°C for other use

**Pumped liquid characteristics** clean, free from solids or abrasive substances, not viscous, not aggressive, not crystallised and chemically neutral.

**Maximum ambient temperature** +40°C

**Maximum working pressure**

6 bar (600 kPa) for Jet and Jetcom  
8 bar (800 kPa) for Jetinox

**Protection level**

IP 44 (IP 55 terminal board protection).

**Insulation class** F

IE3 ≥ 0,75 kW

IE2 ≥ 0,75 kW

EXTRA EU

ACCESSORIES  
PAG. 111

## JET

MODEL	CODE	ELECTRICAL DATA						HYDRAULIC DATA										DNA GAS	DNM GAS	WT. KG	Q.TY x PALLET
		VOLTAGE 50 Hz	P1 MAX KW	P2 NOMINAL		In A	MOTOR TYPE	Q=m <sup>3</sup> /h	0	0,6	1,2	1,8	2,4	3,0	3,6	4,2	4,8				
				kW	HP			Q=l/min	0	10	20	30	40	50	60	70	80				
JET 62 M	102660000	1X220-240 V~	0,72	0,44	0,6	3,12	-	H (m)	42	35	29,2	25,6	22,9	21,1				1"	1"	10,5	28
JET 82 M	102660020	1X220-240 V~	0,85	0,6	0,8	3,8	-		47	40	34	30	26,2	23,5	20,3			1"	1"	10,7	28
JET 82 T	102660030	3X230-400 V~	0,86	0,6	0,8	2,8-1,6	-		47	40	34	30	26,2	23,5	20,3			1"	1"	10,7	28
JET 102 M	102660040	1X220-240 V~	1,13	0,75	1	5,1	-		53,8	47	41	36,3	32,4	28,8	25,8			1"	1"	12,5	28
JET 102 T	60179394	3X230-400 V~	1,03	0,75	1	3,4-2	IE3		53,8	47	41	36,3	32,4	28,8	25,8			1"	1"	12,5	28
JET 112 M	102660060	1X220-240 V~	1,4	1	1,36	6,2	-		61	54	47,8	42,8	38,8	34,8	20			1"	1"	13,5	28
JET 112 T	60179414	3X230-400 V~	1,35	1	1,36	4,1-2,4	IE3		61	54	47,8	42,8	38,8	34,8	20			1"	1"	13,5	28
JET 92 M	102660080	1X220-240 V~	0,94	0,75	1	4,2	-		36,2	33,5	31	28,4	26	24	21,8	19,6	17	1"	1"	11,7	28
JET 132 M	102660100	1X220-240 V~	1,49	1	1,36	6,6	-		48,3	45,6	42,8	40	37,6	35	32,5	30	27,2	1"	1"	13,5	28
JET 132 T	60179413	3X230-400 V~	1,37	1	1,36	4,3-2,5	IE3		48,3	45,6	42,8	40	37,6	35	32,5	30	27,2	1"	1"	13,5	28
JET 102 T	60145173	3X230-400 V~	1,04	0,75	1	3,3-1,9	IE2	H (m)	53,8	47	41	36,3	32,4	28,8	25,8			1"	1"	12,5	28
JET 112 T	60145276	3X230-400 V~	1,35	1	1,36	4,3-2,5			61	54	47,8	42,8	38,8	34,8	20			1"	1"	13,5	28
JET 132 T	60145277	3X230-400 V~	1,43	1	1,36	4,7-2,7			48,3	45,6	42,8	40	37,6	35	32,5	30	27,2	1"	1"	13,5	28

## JETINOX

MODEL	CODE	ELECTRICAL DATA						HYDRAULIC DATA										DNA GAS	DNM GAS	WT. KG	Q.TY x PALLET
		VOLTAGE 50 Hz	P1 MAX KW	P2 NOMINAL		In A	MOTOR TYPE	Q=m <sup>3</sup> /h	0	0,6	1,2	1,8	2,4	3,0	3,6	4,2	4,8				
				kW	HP			Q=l/min	0	10	20	30	40	50	60	70	80				
JETINOX 82 M	102640020	1X220-240 V~	0,85	0,6	0,8	3,8	-	H (m)	47	40	34	30	26,2	23,5	20,3			1"	1"	7,8	28
JETINOX 82 T	102640030	3X230-400 V~	0,86	0,6	0,8	2,8-1,6	-		47	40	34	30	26,2	23,5	20,3			1"	1"	7,8	28
JETINOX 102 M	102640040	1X220-240 V~	1,13	0,75	1	5,1	-		53,8	47	41	36,3	32,4	28,8	25,8			1"	1"	9,6	28
JETINOX 102 T	60179395	3X230-400 V~	1,04	0,75	1	3,3-1,9	IE3		53,8	47	41	36,3	32,4	28,8	25,8			1"	1"	9,6	28
JETINOX 112 M	102640060	1X220-240 V~	1,4	1	1,36	6,2	-		61	54	47,8	42,8	38,8	34,8	20			1"	1"	10,6	28
JETINOX 112 T	60179416	3X230-400 V~	1,35	1	1,36	4,3-2,5	IE3		61	54	47,8	42,8	38,8	34,8	20			1"	1"	10,6	28
JETINOX 92 M	102640080	1X220-240 V~	0,94	0,75	1	4,2	-		36,2	33,5	31	28,4	26	24	21,8	19,6	17,5	1"	1"	8,8	28
JETINOX 132 M	102640100	1X220-240 V~	1,49	1	1,36	6,6	-		48,3	45,6	42,8	40	37,6	35	32,5	30	27,2	1"	1"	10,6	28
JETINOX 132 T	60179415	3X230-400 V~	1,43	1	1,36	4,7-2,7	IE3		48,3	45,6	42,8	40	37,6	35	32,5	30	27,2	1"	1"	10,6	28
JETINOX 102 T	60145172	3X230-400 V~	1,04	0,75	1	3,3-1,9	IE2		H (m)	53,8	47	41	36,3	32,4	28,8	25,8			1"	1"	9,6
JETINOX 112 T	60145274	3X230-400 V~	1,35	1	1,36	4,3-2,5		61		54	47,8	42,8	38,8	34,8	20			1"	1"	10,6	28
JETINOX 132 T	60145275	3X230-400 V~	1,43	1	1,36	4,7-2,7		48,3		45,6	42,8	40	37,6	35	32,5	30	27,2	1"	1"	10,6	28

# JET - JETINOX - JETCOM

SELF-PRIMING CENTRIFUGAL PUMPS



IE3 ≥ 0,75 kW

IE2 ≥ 0,75 kW

EXTRA EU

ACCESSORIES  
PAG. 111

## JETCOM

MODEL	CODE	ELECTRICAL DATA						HYDRAULIC DATA										DNA GAS	DNM GAS	WT. KG	Q.TY x PALLET				
		VOLTAGE 50 Hz	P1 MAX KW	P2 NOMINAL		In A	MOTOR TYPE	Q=m³h	0	0,6	1,2	1,8	2,4	3,0	3,6	4,2	4,8					Q=l/min	0	10	20
JETCOM 62 M	102670000	1X220-240 V~	0,72	0,44	0,6	3,12	-	H (m)	42	35	29,2	25,6	22,9	13				1"	1"	7,5	28				
JETCOM 82 M	102670020	1X220-240 V~	0,85	0,6	0,8	3,8	-		47	40	34	30	26,2	23,5	20			1"	1"	7,7	28				
JETCOM 102 M	102670040	1X220-240 V~	1,13	0,75	1	5,1	-		53,8	47	41	36,3	32,4	28,8	25,8			1"	1"	9,5	28				
JETCOM 102 T	60179396	3X230-400 V~	1,04	0,75	1	3,3-1,9	IE3		53,8	47	41	36,3	32,4	28,8	25,8			1"	1"	9,5	28				
JETCOM 92 M	102670080	1X220-240 V~	0,94	0,75	1	4,2	-		36,2	33,5	31	28,4	26	24	21,8	19,6	17,5	1"	1"	8,7	28				
JETCOM 132 M	102670100	1X220-240 V~	1,49	1	1,36	6,6	-		48,3	45,6	42,8	40	37,6	35	32,5	30	27,2	1"	1"	10,5	28				
JETCOM 132 T	60179417	3X230-400 V~	1,43	1	1,36	4,7-2,7	IE3		48,3	45,6	42,8	40	37,6	35	32,5	30	27,2	1"	1"	10,5	28				
JETCOM 102 T	60145176	3X230-400 V~	1,04	0,75	1	3,3-1,9	IE2		53,8	47	41	36,3	32,4	28,8	25,8			1"	1"	9,5	28				
JETCOM 132 T	60145278	3X230-400 V~	1,43	1	1,36	4,7-2,7	IE2	48,3	45,6	42,8	40	37,6	35	32,5	30	27,2	1"	1"	10,5	28					

## JET 200...251



JET 151-251



JET 200-300

MODEL	CODE	ELECTRICAL DATA						HYDRAULIC DATA															DNA GAS	DNM GAS	WT. KG	Q.TY x PALLET									
		VOLTAGE 50 Hz	P1 MAX KW	P2 NOMINAL		In A	MOTOR TYPE	Q=m³h	0	0,6	1,2	1,8	2,4	3,0	3,6	4,2	4,8	6	7,2	9	9,6	10,5					Q=l/min	0	10	20	30	40	50	60	70
JET 151 M	102160062	1X220-240 V~	1,6	1,1	1,5	7,2	-	H (m)	61	58,2	56	53	50	46	43	36								1 1/4"	1"	31	18								
JET 151 T	60179886	3X230-400 V~	1,56	1,1	1,5	5,5-3,2	IE3		61	58,2	56	53	50	46	43	36								1 1/4"	1"	31	18								
JET 200 M	102160142	1X220-240 V~	2,0	1,5	2	9	-		41			37,5	36,5	35,2	34	33	31,8	29,5	27,2	24	22,8	21,3	1 1/2"	1 1/4"	27,1	18									
JET 200 T	60179888	3X230-400 V~	2,1	1,5	2	6,4-3,7	IE3		41			37,5	36,5	35,2	34	33	31,8	29,5	27,2	24	22,8	21,3	1 1/2"	1 1/4"	27,6	18									
JET 251 M	102160092	1X220-240 V~	2,2	1,85	2,5	10	-		62	60	58	56	54	51	48,5	46	43,5	39	34,2					1 1/4"	1"	35	15								
JET 251 T	60179885	3X230-400 V~	2,1	1,85	2,5	6,4-3,7	IE3		62	60	58	56	54	51	48,5	46	43,5	39	34,2					1 1/4"	1"	30,8	18								
JET 300 M	102160162	1X220-240 V~	2,7	2,2	3	12	-		51			48	47	46	44,5	43	42	40	37	33	32	29	1 1/2"	1 1/4"	31,5	15									
JET 300 T	60179887	3X230-400 V~	2,5	2,2	3	7,4-4,3	IE3		51			48	47	46	44,5	43	42	40	37	33	32	29	1 1/2"	1 1/4"	31,5	18									
JET 151 T	60145787	3X230-400 V~	1,6	1,1	1,5	5,2-3	IE2	H (m)	61	58,2	56	53	50	46	43	36							1 1/4"	1"	31	18									
JET 200 T	60145850	3X230-400 V~	2,0	1,5	2	6,8-3,9			41			37,5	36,5	35,2	34	33	31,8	29,5	27,2	24	22,8	21,3	1 1/2"	1 1/4"	27,6	18									
JET 251 T	60145849	3X230-400 V~	2,2	1,85	2,5	6,9-4			62	60	58	56	54	51	48,5	46	43,5	39	34,2					1 1/4"	1"	30,8	18								
JET 300 T	60145907	3X230-400 V~	2,7	2,2	3	8,5-4,9			51			48	47	46	44,5	43	42	40	37	33	32	29	1 1/2"	1 1/4"	27	18									

# MULTISTAGE CENTRIFUGAL AND SELF-PRIMING PUMPS

PERFORMANCE RANGE

## DP - DOMESTIC WATER SUPPLY

HYDRAULIC DATA (n ≈ 2800 1/min.)																		
MODEL	P2 NOMINAL		EJECTOR TYPE	SUCTION DEPTH	Delivery pressure in bar													
	kW	HP			1,5	2	2,5	3	3,5	4	4,5	5	5,5	6	6,5	7		
					Capacity table in l/h													
DP 82 M - T	0,6	0,8	E 25	9 12 15	1813 1426 900	1080 225 326	446 - -	33 - -	- - -	- - -	- - -	- - -	- - -	- - -	- - -	- - -		
			E 30	9 12 15	1753 1345 1166	1286 965 761	812 608 452	524 329 228	261 162 45	12 0 -	- - -	- - -	- - -	- - -	- - -	- - -	- - -	
DP 102 M - T	0,75	1	E 25	9 12 15	2386 1930 1459	1756 1190 773	1097 536 252	515 87 -	126 - -	- - -	- - -	- - -	- - -	- - -	- - -	- - -	- - -	
			E 30	12 15 18 21	- - - -	1240 1028 785 635	872 701 527 374	566 449 302 180	329 255 150 39	156 96 15 -	- - - -	- - - -	- - - -	- - - -	- - - -	- - - -	- - - -	
DP 151 M - T	1,1	1,5	E 20	9 12 15 18	- - - -	- - - -	- - - -	3470 3110 2710 2360	2890 2510 2100 1700	2220 1850 1380 950	1500 1100 640 -	750 300 -	- - - -	- - - -	- - - -	- - - -	- - - -	
			E 25	15 18 21	- - -	- - -	- - -	2800 2530 2280	2330 2050 1800	1830 1550 1300	1350 1090 860	900 680 470	520 300 -	- - -	- - -	- - -	- - -	- - -
			E 30	21 24 27	- - -	- - -	- - -	1820 1680 1550	1650 1520 1360	1410 1260 1110	1160 1020 880	910 780 680	700 580 490	520 420 330	- - -	- - -	- - -	- - -
DP 251 M - T	1,85	2,5	E 20	9 12 15 18	- - - -	- - - -	- - - -	4300 3750 -	3600 3140 2780 2340	2900 2540 2040 1610	2180 1700 1300 820	1400 940 500 -	640 -	- - -	- - -	- - -	- - -	- - -
			E 25	15 18 21 24	- - - -	- - - -	- - - -	- -	2920 2600 2350 2050	2400 2110 1850 1550	1900 1620 1350 1080	1400 1150 900 660	950 720 510 300	570 360 -	- - -	- - -	- - -	- - -
			E 30	21 24 27	- - -	- - -	- - -	- -	- -	1710 1580 1440	1480 1330 1200	1220 1080 950	980 850 750	770 670 560	590 490 400	420 330 250	- -	- -

M - T = Single-phase (M) and Three-phase (T)

# DP

## PUMPS FOR DEEP SUCTION



DP 82-102



DP 151-251

Self-priming centrifugal pump for suction up to 27 metres, reached by means of an ejector. Cast iron pump body and motor support. Technopolymer impeller and diffusers. Stainless steel adjustment rings. Carbon/ceramic mechanical seal. Cast iron ejector body, technopolymer Venturi tube and brass nozzle. Asynchronous motor closed and cooled by external ventilation. Built-in thermal and current overload protection and a capacitor permanently on in the single-phase version. For the protection of the three-phase motor it is advisable to use a suitable overload protection complying with the regulations in force.

**Operating range** from 0.15 to 4.3 m<sup>3</sup>/h

**Liquid temperature range**

from 0°C to +40°C for other uses  
from 0°C to +35°C for domestic use

**Pumped liquid characteristics** clean, free from solids or abrasive substances, not viscous, not aggressive, not crystallised and chemically neutral.

**Maximum ambient temperature** +40°C

**Maximum working pressure**

6 bar (600 kPa) for DP 82 - DP 102  
8 bar (800 kPa) for DP 151 - DP 251

**Protection level** IP 44

**Insulation class** F

IE3 ≥ 0,75 kW

IE2 ≥ 0,75 kW

EXTRA EU

ACCESSORIES  
PAG. 111

MODEL	CODE	ELECTRICAL DATA					MOTOR TYPE	WEIGHT KG	Q.TY x PALLET
		VOLTAGE 50 Hz	P1 MAX KW	P2 NOMINAL		In A			
				KW	HP				
DP 82 M	102660860	1x220-240 V ~	0,73	0,6	0,8	3,4	-	10,7	28
DP 82 T	102660870	3x230-400 V ~	0,73	0,6	0,8	2,6-1,5	-	10,7	28
DP 102 M	102660880	1x220-240 V ~	0,79	0,75	1	3,8	-	13	28
DP 102 T	60179391	3x230-400 V ~	0,64	0,75	1	2,6-1,5	IE3	13	28
DP 151 M	102161042	1x220-240 V ~	1,56	1,1	1,5	7	-	28	21
DP 151 T	60179923	3x230-400 V ~	1,5	1,1	1,5	5,4-3,1	IE3	28	21
DP 251 M	102161072	1x220-240 V ~	1,84	1,85	2,5	8,3	-	32,5	21
DP 251 T	60179924	3x230-400 V ~	1,7	1,85	2,5	5,7-3,3	IE3	27,9	21
DP 102 T	60145174	3x230-400 V ~	0,64	0,75	1	2,6-1,5	IE2	13	28
DP 151 T	60145799	3x230-400 V ~	1,45	1,1	1,5	4,7-2,7		28	21
DP 251 T	60145851	3x230-400 V ~	-	1,85	2,5	5,6-3,2		27,9	21

## EJECTORS DP

MODEL	CODE
EJECTORS E 20	109200000
EJECTORS E 25	109200020
EJECTORS E 30	109200010



Don't provided with pump, to be ordered separately.

## INSTRUCTIONS FOR CONVERSION

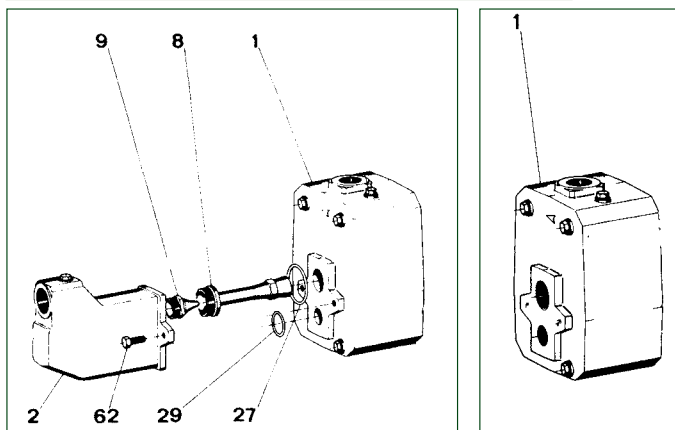

### Conversion from DP 151-251 to JET 151-251

Screw the nozzle (9) into place on the ejector's body (2) and the Venturi tube (8). Put the O-rings (27) and (29) in their respective places and fix the ejector body (2) to the pump body (1) using the two screws (62).

MODEL	CODE
EJECTOR JET 151 ASS.Y	R00009981
EJECTOR JET 251 ASS.Y	R00009983

### Conversion from JET 151-251 to DP 151-251

Loosen and remove the two screws (62) connecting the ejector body (2) to the pump body (1). Save the O-rings (27) and (29), the Venturi tube (8) and the nozzle (9).

# GARDENJET - GARDEN INOX - GARDEN COM

SELF-PRIMING CENTRIFUGAL PUMPS



GARDENJET



GARDEN-INOX



GARDEN-COM

Portable self-priming centrifugal electropump for gardening, vegetable gardens, washing and hobbies.

Equipped with a handle for easy transport and 2-metre power cable type H07 RN-F complete with plug and switch. Compact and easy to install, self-priming so that it can take up water from tanks, wells or streams, tolerating air bubbles and water with small particles of sand.

**Gardenjet:** Cast iron pump body and die-cast aluminium motor support.

**Garden-com:** Technopolymer pump body and die-cast aluminium motor support.

**Garden-inox:** Stainless steel pump body. Die-cast aluminium motor support.

Technopolymer impeller, diffuser and Venturi tube.

Stainless steel seal disc and pressure discs.

Carbon/ceramic mechanical seal.

Induction motor, closed and cooled with external ventilation.

Rotor mounted on oversized greased sealed-for-life ball bearings to ensure silent running and long life.

Built-in thermal and current overload protection and a capacitor permanently in circuit.

Manufactured according to CEI 2-3 and CEI 61-69 standards (EN 60335-2-41).

**Motor protection** IP 44

**Terminal box protection** IP 55

**Insulation class** F

**Standard voltage**

single-phase 220-240 V/50 Hz

**Operating range**

from 0.4 to 5.4 m<sup>3</sup>/h with head up to 54 metres.

**Liquid quality requirements** clean, free from solids or abrasive substances, non viscous, non aggressive, non crystalline neutral, close to the characteristics of water.

**Liquid temperature range**

from 0°C to +35°C for domestic use

(EN 60335-2-41)

from 0°C to +40°C for other uses

**Maximum ambient temperature** +40°C

**Maximum suction depth** 8 metres

**Maximum operating pressure**

8 bar (800 kPa)

6 bar (600 kPa) only for technopolymer models (JETCOM)

**Installation**

fixed or portable in a horizontal position.

Special executions on request: other voltages and/or frequencies.

ACCESSORIES  
PAG. 111

MODEL	CODE	ELECTRICAL DATA					HYDRAULIC DATA										DNA GAS	DNM GAS	WT. KG	Q.TY X PALLET										
		VOLTAGE 50 Hz	P1 MAX KW	P2 NOMINAL		In A	Q=m <sup>3</sup> /h	0	0,6	1,2	1,8	2,4	3,0	3,6	4,2	4,8					Q=l/min	0	10	20	30	40	50	60	70	80
				KW	HP																									
GARDENJET 82 M	102652010	1x220-240 V ~	0,85	0,6	0,8	3,8	H (m)	47	40	34	30	26,2	23,5	20,3			1"	1"	11	28										
GARDENJET 102 M	102652020	1x220-240 V ~	1,13	0,75	1	5,1		53,8	47	41	36,3	32,4	28,8	25,8			1"	1"	12,8	28										
GARDENJET 132 M	102652040	1x220-240 V ~	1,49	1	1,36	6,6		48,3	45,6	42,8	40	37,6	35	32,5	30	27,2	1"	1"	13,8	28										
GARDEN-INOX 82 M	102657010	1x220-240 V ~	0,85	0,6	0,8	3,8		47	40	34	30	26,2	23,5	20,3			1"	1"	10,7	28										
GARDEN-INOX 102 M	102657020	1x220-240 V ~	1,13	0,75	1	5,1		53,8	47	41	36,3	32,4	28,8	25,8			1"	1"	12,5	28										
GARDEN-INOX 132 M	102657040	1x220-240 V ~	1,49	1	1,36	6,6		48,3	45,6	42,8	40	37,6	35	32,5	30	27,2	1"	1"	13,5	28										
GARDEN-COM 62 M	102682000	1x220-240 V ~	0,72	0,44	0,6	3,12		42,7	35	29,2	25,6	22,9	13				1"	1"	10,7	28										
GARDEN-COM 82 M	102682010	1x220-240 V ~	0,85	0,6	0,8	3,8		47	40	34	30	26,2	23,5	20,3			1"	1"	10,7	28										
GARDEN-COM 102 M	102682020	1x220-240 V ~	1,13	0,75	1	5,1		53,8	47	41	36,3	32,4	28,8	25,8			1"	1"	12,5	28										



# EURO - EUROINOX - EUROCOM

## MULTISTAGE CENTRIFUGAL PUMPS



EURO



EUROINOX



EUROCOM

Multistage horizontal centrifugal pump, featuring extremely silent running suitable for domestic use for water supply and pressurisation, irrigation of gardens and vegetable gardens, and moving water in general.

**Euro:** pump body in 200 UNI ISO 185 cast iron.

**Euroinox:** stainless steel pump body.

**Eurocom:** technopolymer pump body.

Motor support in die-cast aluminium, seal holder in AISI 304 steel. Mechanical seal in carbon/ceramic. Rotor shaft in AISI 304 steel. Rotors, diffuser bodies and diffusers in technopolymer. Adjustment rings in stainless steel.

**Protection level of motor** IP 44

**Protection level of terminal board** IP 55

**Insulation class** F

**Operating range** from 10 to 120 l/min. with a head of up to 72 m.

**Pumped liquid characteristics** clean, free from solid or abrasive substances, not viscous, not aggressive, not crystallised, chemically neutral and close to the characteristics of water.

**Liquid temperature range**

from 0°C to +35°C C for domestic use (EN 60335-2-41)

from 0°C to +40°C for other uses.

**Maximum ambient temperature** +40°C

**Maximum operating pressure** 8 bar (800 kPa)

**Euroinox self-priming**, other uses.

**Maximum ambient temperature** +40°C

**Maximum operating pressure** 8 bar (800 kPa)

**Euroinox** self-priming.

IE3 ≥ 0,75 kW

IE2 ≥ 0,75 kW

EXTRA EU

ACCESSORIES  
PAG. 111

## EURO

MODEL	CODE	ELECTRICAL DATA					HYDRAULIC DATA											N° IMPELLERS	DNA GAS	DNM GAS	WT. KG	Q.TY x PALLET		
		VOLTAGE 50 Hz	P1 MAX KW	P2 NOMINAL		In A	MOTOR TYPE	Q=m³h	0	0,6	1,2	1,8	2,4	3,0	3,6	4,2	4,8						6	7,2
EURO 25/30 M	102970000	1x220-240 V ~	0,52	0,37	0,5	2,4	-	34,4	31,7	28,3	23,5	17,5	11							3	1"	1"	10,7	28
EURO 30/30 M	60169377	1x220-240 V ~	0,83	0,45	0,6	3,9	-	46	42,2	37,8	31,2	23,3	14,3							4	1"	1"	12,7	28
EURO 40/30 M	102970040	1x220-240 V ~	0,88	0,55	0,75	3,9	-	57	52,7	47	38,8	29	17,7							5	1"	1"	12,8	28
EURO 30/50 M	102970060	1x220-240 V ~	0,880	0,55	0,75	3,9	-	42,5	40,2	38,2	36,2	33,8	30	24,8	19,5	14				3	1"	1"	11,7	28
EURO 40/50 M	102970080	1x220-240 V ~	1,200	0,75	1	5,3	-	57,5	55,3	52,8	50,1	47,1	42,7	35,8	28	19				4	1"	1"	15,6	28
EURO 40/50 T	60179428	3x230-400 V ~	1,07	0,75	1	3,6-2,1	IE3	57,5	55,3	52,8	50,1	47,1	42,7	35,8	28	19				4	1"	1"	15,6	28
EURO 50/50 M	102970100	1x220-240 V ~	1,480	1	1,36	6,3	-	72	68,5	65,5	62,1	58,2	52,2	43,6	34,5	26				5	1"	1"	16,2	28
EURO 50/50 T	60179426	3x230-400 V ~	1,3	1	1,36	4,1-2,4	IE3	72	68,5	65,5	62,1	58,2	52,2	43,6	34,5	26				5	1"	1"	16,2	28
EURO 30/80 M	102970140	1x220-240 V ~	1,2	0,8	1,1	5,2	-	47	46,5	45	43,5	41	38	34,5	31	23	12			4	1"	1"	15,6	28
EURO 30/80 T	60179424	3x230-400 V ~	1,06	0,8	1,1	3,6-2,1	IE3	47	46,5	45	43,5	41	38	34,5	31	23	12			4	1"	1"	15,6	28
EURO 40/80 M	102970160	1x220-240 V ~	1,48	1	1,36	6,3	-	59	57	56	54	51	47	43,5	39	29,5	16,5			5	1"	1"	16,2	28
EURO 40/80 T	60179422	3x230-400 V ~	1,3	1	1,36	4,1-2,4	IE3	59	57	56	54	51	47	43,5	39	29,5	16,5			5	1"	1"	16,2	28
EURO 40/50 T	60145283	3x230-400 V ~	1,180	0,75	1	3,8/2,2	IE2	57,5	55,3	52,8	50,1	47,1	42,7	35,8	28	19				4	1"	1"	15,6	28
EURO 50/50 T	60145284	3x230-400 V ~	1,440	1	1,36	4,4/2,5		72	68,5	65,5	62,1	58,2	52,2	43,6	34,5	26				5	1"	1"	16,2	28
EURO 30/80 T	60145285	3x230-400 V ~	1,18	0,8	1,1	3,8/2,2		47	46,5	45	43,5	41	38	34,5	31	23	12			4	1"	1"	15,6	28
EURO 40/80 T	60145286	3x230-400 V ~	1,44	1	1,36	4,4/2,5		59	57	56	54	51	47	43,5	39	29,5	16,5			5	1"	1"	16,2	28

# EURO - EUROINOX - EUROCOM

MULTISTAGE CENTRIFUGAL PUMPS



IE3 ≥ 0,75 kW

IE2 ≥ 0,75 kW

EXTRA EU

## EUROINOX

MODEL	CODE	ELECTRICAL DATA						HYDRAULIC DATA														N° IMPELLERS	DNA GAS	DNM GAS	WT. KG	Q.TY x PALLET	
		VOLTAGE 50 Hz	P1 MAX KW	P2 NOMINAL		In A	MOTOR TYPE	Q=m³h	0	0,6	1,2	1,8	2,4	3,0	3,6	4,2	4,8	6	7,2								
				Q=l/min	0			10	20	30	40	50	60	70	80	100	120										
EUROINOX 25/30 M	102970200	1x220-240 V ~	0,520	0,37	0,5	2,4	-	H (m)	34	31,7	28,3	23,5	17,5	11								3	1"	1"	9,7	28	
EUROINOX 30/30 M	102970220	1x220-240 V ~	0,720	0,45	0,6	3,2	-		46	42,2	37,8	31,2	23,3	14,3									4	1"	1"	11,7	28
EUROINOX 40/30 M	102970240	1x220-240 V ~	0,880	0,55	0,75	3,9	-		57	52,7	47	38,8	29	17,7									5	1"	1"	11,9	28
EUROINOX 30/50 M	102970260	1x220-240 V ~	0,880	0,55	0,75	3,9	-		42	40,2	38,2	36,2	33,8	30	24,8	19,5	14						3	1"	1"	10,5	28
EUROINOX 30/50 T	102970270	3x230-400 V ~	0,870	0,55	0,75	2,8-1,6	-		42	40,2	38,2	36,2	33,8	30	24,8	19,5	14						3	1"	1"	10,5	28
EUROINOX 40/50 M	102970280	1x220-240 V ~	1,200	0,75	1	5,3	-		58	55,3	52,8	50,1	47,1	42,7	35,8	28	19						4	1"	1"	14,6	28
EUROINOX 40/50 T	60179419	3x230-400 V ~	1,07	0,75	1	3,6-2,1	IE3		58	55,3	52,8	50,1	47,1	42,7	35,8	28	19						4	1"	1"	14,6	28
EUROINOX 50/50 M	102970300	1x220-240 V ~	1,480	1	1,36	6,3	-		72	68,5	65,5	62,1	58,2	52,2	43,6	34,5	26						5	1"	1"	15,1	28
EUROINOX 50/50 T	60179421	3x230-400 V ~	1,3	1	1,36	4,1-2,4	IE3		72	68,5	65,5	62,1	58,2	52,2	43,6	34,5	26						5	1"	1"	15,1	28
EUROINOX 30/80 M	102970340	1x220-240 V ~	1,200	0,8	1,1	5,2	-		47	46,5	45	43,5	41	38	34,5	31	23	12				4	1"	1"	14,6	28	
EUROINOX 30/80 T	60179423	3x230-400 V ~	1,06	0,8	1,1	3,6-2,06	IE3		47	46,5	45	43,5	41	38	34,5	31	23	12				4	1"	1"	14,6	28	
EUROINOX 40/80 M	102970360	1x220-240 V ~	1,48	1	1,36	6,3	-		59	57	56	54	51	47	43,5	39	29,5	16,5				5	1"	1"	15,1	28	
EUROINOX 40/80 T	60179418	3x230-400 V ~	1,3	1	1,36	4,1-2,4	IE3		59	57	56	54	51	47	43,5	39	29,5	16,5				5	1"	1"	15,1	28	
EUROINOX 40/50 T	60145287	3x230-400 V ~	1,180	0,75	1	3,8-2,2	IE2		H (m)	58	55,3	52,8	50,1	47,1	42,7	35,8	28	19				4	1"	1"	14,6	28	
EUROINOX 50/50 T	60145288	3x230-400 V ~	1,440	1	1,36	4,4-2,5				72	68,5	65,5	62,1	58,2	52,2	43,6	34,5	26				5	1"	1"	15,1	28	
EUROINOX 30/80 T	60145289	3x230-400 V ~	1,18	0,8	1,1	3,8-2,2				47	46,5	45	43,5	41	38	34,5	31	23	12				4	1"	1"	14,6	28
EUROINOX 40/80 T	60145290	3x230-400 V ~	1,44	1	1,36	4,4-2,5		59		57	56	54	51	47	43,5	39	29,5	16,5				5	1"	1"	15,1	28	

## EUROCOM

MODEL	CODE	ELECTRICAL DATA						HYDRAULIC DATA														N° IMPELLERS	DNA GAS	DNM GAS	WT. KG	Q.TY x PALLET
		VOLTAGE 50 Hz	P1 MAX KW	P2 NOMINAL		In A	MOTOR TYPE	Q=m³h	0	0,6	1,2	1,8	2,4	3,0	3,6	4,2	4,8	6	7,2							
				Q=l/min	0			10	20	30	40	50	60	70	80	100	120									
EUROCOM 25/30 M	102960000	1x220-240 V ~	0,520	0,37	0,5	2,4	-	H (m)	34,4	31,7	28,3	23,5	17,5	11							3	1"	1"	8	28	
EUROCOM 30/50 M	102960060	1x220-240 V ~	0,880	0,55	0,75	3,9	-		42,2	40,2	38,2	36,2	33,8	30	24,8	19,5	14				3	1"	1"	8,8	28	
EUROCOM 40/50 M	102960080	1x220-240 V ~	1,200	0,75	1	5,3	-		57,7	55,3	52,8	50,1	47,1	42,7	35,8	28	19,2				4	1"	1"	11	28	
EUROCOM 40/50 T	60179427	3x230-400 V ~	1,180	0,75	1	3,8-2,2	IE3		57,7	55,3	52,8	50,1	47,1	42,7	35,8	28	19,2				4	1"	1"	11	28	
EUROCOM 30/80 T	60179425	3x230-400 V ~	1,040	0,8	1,1	3,3-1,9			47	46,5	45	43,5	41	38	34,5	31	23	12				4	1"	1"	11	28
EUROCOM 40/50 T	60145279	3x230-400 V ~	1,180	0,75	1	3,8-2,2	IE2	H (m)	57,7	55,3	52,8	50,1	47,1	42,7	35,8	28	19,2				4	1"	1"	11	28	
EUROCOM 30/80 T	60145280	3x230-400 V ~	1,040	0,8	1,1	3,3-1,9			47	46,5	45	43,5	41	38	34,5	31	23	12				4	1"	1"	11	28

# MULTI INOX

## SELF-PRIMING HORIZONTAL MULTISTAGE PUMPS



Self-priming multistage pumps ideal for water supply in domestic and garden applications. High performances. Available with 3 - 4 - 5 **impellers in AISI 304 stainless steel**.  
Materials resistant to corrosion and oxidation.  
Motor with thermal overload protection.  
Double insulation between motor and hydraulic section.  
Optimal resistance to low temperatures.  
Supplied complete with power cable and plug.

### Liquid temperature range

from 0°C to +35°C (for domestic use)  
(EN 60335-2-41)  
from 0°C to +40°C (for other uses).

ACCESSORIES  
PAG. 111

MODEL	CODE	ELECTRICAL DATA					HYDRAULIC DATA														N° IMPELLERS	DNA GAS	DNM GAS	WT. KG	Q.TY X PALLET	
		VOLTAGE 50 Hz	P1 MAX KW	P2 NOMINAL		In A	Q=m³h	0	0,6	1,2	1,8	2,4	3,0	3,6	4,2	4,8	5,4	Q=l/min	0	10						20
<b>MULTI INOX 3 M</b>	60122692	1x220-240 V ~	0,80	0,55	0,75	3,7	H (m)	33	32	30	29	27	22	19	14	10	5	3	1"	1"	8,8	21				
<b>MULTI INOX 4 M</b>	60122693	1x220-240 V ~	1,00	0,75	1	4,5		46	45	43	40	38	33	28	22	16	9	4	1"	1"	11,3	21				
<b>MULTI INOX 5 M</b>	60122694	1x220-240 V ~	1,25	1	1,36	5,5		59	58	56	53	49	45	38	32	25	13	5	1"	1"	12,5	21				

# JET M-P - JETINOX M-P - EUROINOX M-P

CENTRIFUGAL PUMPS FITTED



EUROINOX M-P



JET 151-251 T-P

## SINGLE-PHASE VERSION

Self-priming pump equipped with gauge, pressure switch, power supply cable with plug and three-way brass fitting for connecting to a tank.

## THREE-PHASE VERSION

Self-priming electropump equipped with gauge, pressure switch, overload cutout and three-way brass fitting for connecting to a tank.

## Operating range

from 0.4 to 10.5 m<sup>3</sup>/h with head up to 62 metres.

**Liquid quality requirements** clean, free from solid or abrasive contaminants, non-viscous, non-aggressive, uncrystallised and chemically neutral, close to the properties of water.

**Liquid temperature range** from 0°C to +35°C for domestic use (EN 60335-2-41).  
For other use: from 0°C to +40°C

**Maximum ambient temperature** +40°C

**Maximum operating pressure** 8 bar (800 kPa)

**Installation** fixed in a horizontal position.

**Special executions on request**  
different frequencies and/or voltage.

**Motor protection rating** IP 44

**Terminal block protection rating** IP 55

**Insulation class** F

**Standard input voltage**

single phase 220/240 V / 50 Hz

three phase 230/400 V - 50 Hz

IE3 ≥ 0,75 kW

IE2 ≥ 0,75 kW

EXTRA EU

ACCESSORIES  
PAG. 111

## JET M-P - JETINOX M-P

MODEL	CODE	ELECTRICAL DATA					HYDRAULIC DATA																				
		VOLTAGE 50 Hz	P1 MAX KW	P2 NOMINAL		In A	MOTOR TYPE	Q=m <sup>3</sup> h	0	0,6	1,2	1,8	2,4	3,0	3,6	4,2	4,8	6	7,2	9	9,6	10,5	DNA GAS	DNM GAS	WT. KG	Q.TY x PALLET	
JET 62 M-P	102662000	1x220-240 V~	0,72	0,44	0,6	3,12	-	Q=1/min	0	10	20	30	40	50	60	70	80	100	120	150	160	175	1"	1"	11,5	24	
JET 82 M-P	102662020	1x220-240 V~	0,85	0,6	0,8	3,8	-		42	35	29,2	25,6	22,9	21,1										1"	1"	12,1	24
JET 102 M-P	102662040	1x220-240 V~	1,13	0,75	1	5,1	-		53,8	47	41	36,3	32,4	28,8	25,8									1"	1"	13,9	24
JET 132 M-P	102662100	1x220-240 V~	1,49	1	1,36	6,6	-		48,3	45,6	42,8	40	37,6	35	32,5	30	27,2							1"	1"	14,9	24
JET 200 M-P	102162182	1x220-240 V~	2	1,5	2	9	-		41			37,5	36,5	35,2	34	33	31,8	29,5	27,2	24	22,8	21,3	1 1/2"	1 1/4"	27,5	9	
JET 200 T-P	60180134	3x400 V~	2	1,5	2	3,9	IE3		41			37,5	36,5	35,2	34	33	31,8	29,5	27,2	24	22,8	21,3	1 1/2"	1 1/4"	28	9	
JET 300 M-P	102162192	1x220-240 V~	2,7	2,2	3	12	-		51			48	47	46	44,5	43	42	40	37	33	32	29	1 1/2"	1 1/4"	31,5	9	
JET 300 T-P	60180135	3x400 V~	2,7	2,2	3	8,5-4,9	IE3		51			48	47	46	44,5	43	42	40	37	33	32	29	1 1/2"	1 1/4"	31	9	
JET 151 M-P	102162062	1x220-240 V~	1,6	1,1	1,5	7,2	-		61	58,2	56	53	50	46	43	36							1 1/4"	1"	31,5	18	
JET 151 T-P	60180136	3x400 V~	1,6	1,1	1,5	5,2-3	IE3		61	58,2	56	53	50	46	43	36							1 1/4"	1"	33	18	
JET 251 M-P	102162082	1x220-240 V~	2,2	1,85	2,5	10	-		62	60	58	56	54	51	48,5	46	43,5	39	34,2				1 1/4"	1"	36	15	
JET 251 T-P	60180137	3x400 V~	2,2	1,85	2,5	6,9-4	IE3		62	60	58	56	54	51	48,5	46	43,5	39	34,2				1 1/4"	1"	34	15	
JET 200 T-P	60147316	3x400 V~	2	1,5	2	3,9	IE2		41			37,5	36,5	35,2	34	33	31,8	29,5	27,2	24	22,8	21,3	1 1/2"	1 1/4"	28	9	
JET 300 T-P	60147318	3x400 V~	2,7	2,2	3	8,5-4,9			51			48	47	46	44,5	43	42	40	37	33	32	29	1 1/2"	1 1/4"	30	9	
JET 151 T-P	60147315	3x400 V~	1,6	1,1	1,5	5,2-3			61	58,2	56	53	50	46	43	36								1 1/4"	1"	33	18
JET 251 T-P	60147317	3x400 V~	2,2	1,85	2,5	6,9-4			62	60	58	56	54	51	48,5	46	43,5	39	34,2					1 1/4"	1"	34	15
JETINOX 82 M-P	102642020	1x220-240 V~	0,85	0,6	0,8	3,8	-		47	40	34	30	26,2	23,5	20,3								1"	1"	13,6	18	
JETINOX 102 M-P	102642040	1x220-240 V~	1,13	0,75	1	5,1	-		53,8	47	41	36,3	32,4	28,8	25,8								1"	1"	14,8	18	
JETINOX 132 M-P	102642100	1x220-240 V~	1,49	1	1,36	6,6	-		48,3	45,6	42,8	40	37,6	35	32,5	30	27,2						1"	1"	15,8	18	

## EUROINOX M-P

MODEL	CODE	ELECTRICAL DATA					HYDRAULIC DATA													DNA GAS	DNM GAS	WT. KG	Q.TY x PALLET			
		VOLTAGE 50 Hz	P1 MAX KW	P2 NOMINAL KW	HP	In A	Q=m <sup>3</sup> h	0	0,6	1,2	1,8	2,4	3,0	3,6	4,2	4,8	6	7,2								
EUROINOX 30/50 M-P	102972260	1 x 220-240 V~	0,88	0,55	0,75	3,9	H (m)	Q=1/min	0	10	20	30	40	50	60	70	80	100	120				1"	1"	11,4	12
EUROINOX 40/50 M-P	102972280	1 x 220-240 V~	1,2	0,8	1,1	5,3			58	55,3	52,8	50,1	47,1	42,7	35,8	28	19						1"	1"	14,5	12
EUROINOX 30/80 M-P	102972340	1 x 220-240 V~	1,2	0,75	1	5,3			47			46,5	45	43,5	41	38	34,5	31	23	12			1"	1"	14,5	12
EUROINOX 40/80 M-P	102972360	1 x 220-240 V~	1,48	1	1,36	6,3			59			57	56	54	51	47	43,5	39	29,5	16,5			1"	1"	17,5	12

# AQUAJET - AQUAJETINOX

SELF-PRIMING AUTOMATIC BOOSTER



Automatic water lifting units, suitable for domestic use, small installations for civil, agricultural, industrial use, washing and hobby applications.

The unit is equipped with a JET or JETINOX type self-priming electropump, vessel, pressure switch for automatic operation, pressure gauge, fitting kit between pump and motor, all pre-assembled. Tank: horizontal, 20 litres capacity type, inner single diaphragm high-grade butyl membrane and virgin polypropylene liner, complete with stands at the bottom and brackets for fixing the pump to the top.

### Operating range

up to 5.4 m<sup>3</sup>/h with head up to 61 metres

### Liquid temperature range

from 0°C to +35°C for domestic use  
from 0°C to +40°C for other use

**Pumped liquid characteristics** clean, free from solids or abrasive substances, not viscous, not aggressive, not crystallised and chemically neutral.

**Maximum ambient temperature** +40°C

**Maximum working pressure** 8 bar (800 kPa)

### Protection level

IP 44 (IP 55 terminal board protection).

**Insulation class** F

TANK WITH **5 YEARS**  
OF GUARANTEE



ACCESSORIES  
PAG. 111

## AQUAJET

MODEL	CODE	ELECTRICAL DATA					HYDRAULIC DATA										DNA GAS	DNM GAS	WT. KG	Q.TY X PALLET	
		VOLTAGE 50 Hz	P1 MAX KW	P2 NOMINAL		In A	Q=m <sup>3</sup> /h	0	0,6	1,2	1,8	2,4	3,0	3,6	4,2	4,8					Q.TY X PALLET
				kW	HP		Q=l/min	0	10	20	30	40	50	60	70	80					
AQUAJET 82 M - G	60121345	1x220-240 V ~	0,85	0,6	0,8	3,8	H (m)	47	40	34	30	26,2	23,5	20,3			1"	1"	18,2	12	
AQUAJET 102 M - G	60121344	1x220-240 V ~	1,13	0,75	1	5,1		53,8	47	41	36,3	32,4	28,8	25,8			1"	1"	20,0	12	
AQUAJET 112 M - G	60141881	1x220-240 V ~	1,4	1	1,36	6,2		61	54	47,8	42,8	38,8	34,8	22			1"	1"	21,0	12	
AQUAJET 92 M - G	60141882	1x220-240 V ~	0,94	0,75	1	4,2		36,2	33,5	31	28,4	26	24	21,8	19,6	17,5	1"	1"	19,2	12	
AQUAJET 132 M - G	60141883	1x220-240 V ~	1,43	1	1,36	4,7-2,7		48,3	45,6	42,8	40	37,6	35	32,5	30	27,2	1"	1"	21,0	12	

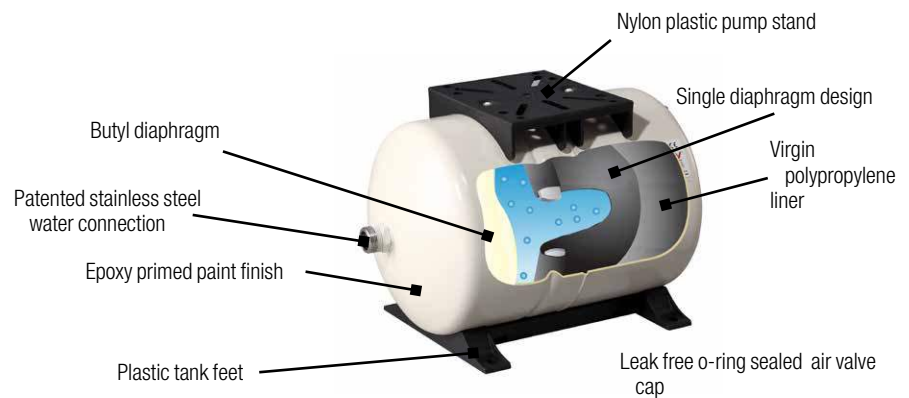

## AQUAJETINOX

MODEL	CODE	ELECTRICAL DATA					HYDRAULIC DATA										DNA GAS	DNM GAS	WT. KG	Q.TY X PALLET	
		VOLTAGE 50 Hz	P1 MAX KW	P2 NOMINAL		In A	Q=m <sup>3</sup> /h	0	0,6	1,2	1,8	2,4	3,0	3,6	4,2	4,8					Q.TY X PALLET
				kW	HP		Q=l/min	0	10	20	30	40	50	60	70	80					
AQUAJET-INOX 82 M - G	60141884	1x220-240 V ~	0,85	0,6	0,8	3,8	H (m)	47	40	34	30	26,2	23,5	20,3			1"	1"	15,3	12	
AQUAJET-INOX 102 M - G	60141885	1x220-240 V ~	1,13	0,75	1	5,1		53,8	47	41	36,3	32,4	28,8	25,8			1"	1"	17,1	12	
AQUAJET-INOX 112 M - G	60141886	1x220-240 V ~	1,4	1	1,36	6,2		61	54	47,8	42,8	38,8	34,8	20			1"	1"	18,1	12	
AQUAJET-INOX 132 M - G	60141888	1x220-240 V ~	1,43	1	1,36	4,7-2,7		4,3	45,6	42,8	40	37,6	35	32,5	30	27,2	1"	1"	18,1	12	

# ACTIVE SYSTEM

ON/OFF AUTOMATIC ELECTRONIC BOOSTER SYSTEMS



ACTIVE J



ACTIVE EI

Automatic lifting units, particularly suitable for domestic use, small systems for civil, agricultural and industrial use, washing systems and hobby applications.

They are characterised by the use of:

- self-priming motor-driven pumps JET, JETINOX, EUROINOX that can even work when there are bubbles of air or gas. They are essential for drawing from artesian wells or wherever suction difficulties arise. The EURO - EUROCOM multistage centrifugal pumps are particularly appropriate for low-noise underwater operation.

The **ACTIVE** system helps increase pressure in systems where it is insufficient or irregular.

The **ACTIVE** system is a built-in, easy-to-install, and ready-to-use device which:

- controls it
- commands it automatically
- controls its operation
- limits starts
- guarantees pressure stability inside the hydraulic circuit.
- electronically controls starting pressure

## Operating range

from 0.4 to 4.8 m<sup>3</sup>/h with head up to 57 metres.

Liquid quality requirements: clean, free from solid or abrasive contaminants, non-viscous, non-aggressive, uncrystallised and chemically neutral, close to the properties of water.

**Liquid temperature range** from 0°C to +35°C for domestic use (EN 60335-2-41).

For other use: from 0°C to +40°C

**Maximum ambient temperature** +40°C

**Maximum operating pressure** 8 bar (800 kPa)

**Installation** fixed in a horizontal position.

**Special executions on request** different frequencies and/or voltage.

**Motor protection rating** IP 44

**Terminal block protection rating** IP 55

**Insulation class** F

**Standard input voltage**

single phase 220/240 V / 50 Hz

three phase 230/400 V - 50 Hz

MODEL	CODE	ELECTRICAL DATA					HYDRAULIC DATA														Q.TY X PALLET	
		VOLTAGE 50 Hz	P1 MAX KW	P2 NOMINAL		In A	Q=m <sup>3</sup> h Q=l/min	H (m)														
				KW	HP			0	0,6	1,2	1,8	2,4	3,0	3,6	4,2	4,8	6	7,2	DNA GAS	DNM GAS		WEIGHT KG
ACTIVE J 82 M	102690010	1x220-240 V ~	0,85	0,6	0,8	3,8	47	40	34	30	26,2	23,5	20,3						1"	1"	13,2	14
ACTIVE J 102 M	102690020	1x220-240 V ~	1,13	0,75	1	5,1	53,8	47	41	36,3	32,4	28,8	25,8						1"	1"	12,5	14
ACTIVE J 132 M	102690050	1x220-240 V ~	1,49	1	1,36	6,6	48,3	45,6	42,8	40	37,6	35	32,5	30	27,2				1"	1"	13,5	14
ACTIVE JI 82 M	102690210	1x220-240 V ~	0,85	0,6	0,8	3,8	47	40	34	30	26,2	23,5	20,3						1"	1"	10,7	14
ACTIVE JI 102 M	102690220	1x220-240 V ~	1,13	0,75	1	5,1	53,8	47	41	36,3	32,4	28,8	25,8						1"	1"	12,5	14
ACTIVE JI 132 M	102690250	1x220-240 V ~	1,49	1	1,36	6,6	48,3	45,6	42,8	40	37,6	35	32,5	30	27,2				1"	1"	13,5	14
ACTIVE JC 102 M	102690420	1x220-240 V ~	1,13	0,75	1	5,1	53,8	47	41	36,3	32,4	28,8	25,8						1"	1"	12,5	14
ACTIVE JC 132 M	102690450	1x220-240 V ~	1,49	1	1,36	6,6	48,3	45,6	42,8	40	37,6	35	32,5	30	27,2				1"	1"	13,5	14
ACTIVE EI 30/50 M	102690830	1x220-240 V ~	0,88	0,55	0,75	3,9	42,2	40,2	38,2	36,2	33,8	30	24,8	19,5	14				1"	1"	10,0	14
ACTIVE EI 40/50 M	102690840	1x220-240 V ~	1,20	0,8	1,1	5,3	57,7	55,3	52,8	50,1	47,1	42,7	35,8	28	19,2				1"	1"	15,5	14
ACTIVE EI 50/50 M	102690850	1x220-240 V ~	1,48	1	1,36	6	72	68,5	65,5	62,1	58,2	52,2	48	43,6	34,5	26			1"	1"	15,2	14
ACTIVE EI 25/80 M	102690860	1x220-240 V ~	0,880	0,55	0,75	3,9	34		33	32	30,5	28,5	26	23,5	21	14,5	6,5		1"	1"	9,5	14
ACTIVE EI 40/80 M	102690880	1x220-240 V ~	1,48	1	1,36	6	59	58	57	56	54	51	47,5	43,8	39,5	29,5	16		1"	1"	15	14

## INCLUDED ACCESSORIES

MODEL
ACTIVE FLEXIBLE PIPE FOR HYDRAULIC CONNECTION



ACTIVE FLEXIBLE PIPE

# BOOSTER SILENT

ON/OFF AUTOMATIC ELECTRONIC BOOSTER SYSTEMS



The world's quietest (67 dB) multi-impeller (3-4-5) self-priming pumps, with integral electronics for water supplies in homes and gardens. Equipped with an electronic safety device to prevent dry running. Integral check valve on suction.

Automatic Starting and Stopping when tap is turned on or turned off. Manual and automatic reset

**Supplied complete with power cable and plug.**  
**Supplied with 2 l tank.**

### Operating range

capacity up to 90 l/min; head up to 46 m.

### Liquid temperature range

**for domestic use** from +35°C to +35°C

**for other use** from 0°C to +40°C

### Liquid quality requirements

Clean, free from solid or abrasive contaminants, non-viscous, non-aggressive, uncrystallised and chemically neutral.

**Maximum suction depth** 8 metres

**Maximum ambient temperature** +40°C

**Protection rating** IPX4

**Insulation class** F

### Installation

fixed or portable in a horizontal position.

### Special executions on request

alternative voltages and/or frequencies.

TANK WITH **5 YEARS**  
OF GUARANTEE

**67 dB**

ACCESSORIES  
PAG. 111

MODEL	CODE	ELECTRICAL DATA				HYDRAULIC DATA												N° IMPELLERS	DNA GAS	DNM GAS	WT. KG	Q.TY x PALLET		
		VOLTAGE 50 Hz	P1 MAX KW	P2 NOMINAL		In A	Q=m³h	0	0,6	1,2	1,8	2,4	3,0	3,6	4,2	4,8	Q=l/min						0	10
BOOSTER SILENT 3 M	60122696	1 x 230 V ~	0,8	0,55	0,75	3,7	H (m)	37	34	32	31	27	23	19	15	8	3	1"	1"	11,5	18			
BOOSTER SILENT 4 M	60122698	1 x 230 V ~	1	0,75	1	4,7		47	43	40	35	31	27	22	17	9	4	1"	1"	11,5	18			
BOOSTER SILENT 5 M	60122699	1 x 230 V ~	1,25	1	1,36	5,7		57	52	48	43	38	31	25	18	10	5	1"	1"	11,5	18			

## INCLUDED ACCESSORIES

RIF.	DESCRIPTION
<b>A</b>	<b>3-WAY FITTING</b>
<b>B</b>	<b>STRAIGHT FITTING</b>
<b>C</b>	<b>2 LT TANK:</b> <ul style="list-style-type: none"> <li>· diaphragm high-grade butyl membrane</li> <li>· Patented stainless steel water connection</li> <li>· Epoxy primed paint finish</li> <li>· Single diaphragm design</li> <li>· Virgin polypropylene liner</li> <li>· Leak free o-ring sealed air valve cap</li> </ul>



# ESYBOX MINI<sup>3</sup>

ELECTRONIC PRESSURISATION SYSTEM



ESYBOX MINI<sup>3</sup> is the DAB compact automatic pressurisation system for the water supply of a single dwelling. ESYBOX MINI<sup>3</sup> guarantees the comfort of constant pressure (Pressure Set Point adjustable from 1 up to 5,5 bar) inside the system, and energy savings thanks to the inverter technology. Suitable for use with drinking water, in domestic systems, and in gardening applications. ESYBOX MINI<sup>3</sup> does not require any additional components for its installation.

It consists of a high frequency self-priming double impeller pump, management inverter electronics, pressure and flow sensors, adjustable high resolution LCD display with 1 litre built-in expansion vessel, and cartridge check valve.

The double suction and delivery ports allow both vertical and horizontal installation. Thanks to its compact sizes, installation is also possible in difficult places without high air exchange.

### Operating range

capacity up to 80 l/min; head up to 55 m

**Liquid quality requirements** clean, free from solid or abrasive contaminants, non-viscous, non-aggressive, uncrystallised and chemically neutral.

**Liquid temperature range** from 0°C to +35°C for domestic use

**for other use** from 0°C to +40°C

**Maximum suction depth** 8 meters

**Maximum ambient temperature** +50°C

**Maximum operating pressure**  
7,5 bar (750 kPa)

**Motor protection rating** IPX4

**Insulation class** F

**Installation** Horizontal or vertical fixed position

**Special executions on request**  
alternative types of electrical plug

## esybox mini<sup>3</sup>

D+CONNECT PAG. 5

MODEL	CODE	N° IMPELLERS	ELECTRICAL DATA			HYDRAULIC DATA								DNA GAS	DNM GAS	WT. KG	Q.TY X PALLET		
			VOLTAGE 50 - 60 Hz	P1 MAX		In A	Q=m <sup>3</sup> h	0,6	1,2	1,8	2,4	3,0	3,6					4,2	4,8
ESYBOX MINI 3	60179457	2	1x220-240V ~	0,85	1,1	4,8	Q=l/min	10	20	30	40	50	60	70	80	1"	1"	14,6	18
ESYBOX MINI 3 - KIWA	60183505	2	1x220-240V ~	0,85	1,1	4,8	H (m)	55,0	55,0	49,0	39,0	31,0	23,0	14,0	4,0	1"	1"	14,6	18

The KIWA version is provided with additional pressure sensor in the suction side that blocks the pump if the inlet pressure is below the set limit, compliant with the KIWA standards.

### APPLICATIONS



### Esybox mini<sup>3</sup>

Apartments up to 3 floors, 2 bathrooms and 50m<sup>2</sup> of garden.\*

\*Indicative data. Please refer to the technical catalogue or DNA for correct sizing.

### CERTIFICATIONS



### SUITABLE FOR PUMPING WATER FROM:



WELLS DOWN TO 8 M DEEP

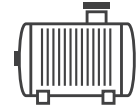

RAINWATER COLLECTION TANKS



TANKS



AQUEDUCT where permitted by law

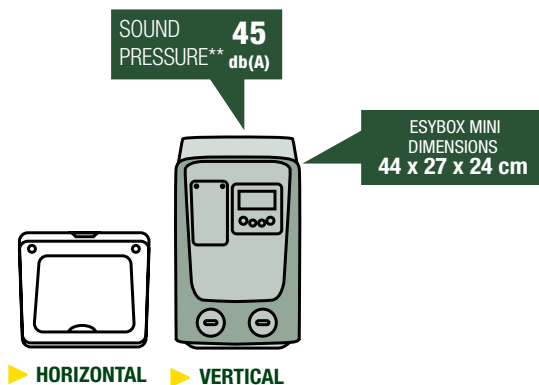

\*Compared to a traditional booster set in terms of medium usage conditions.

\*\* Sound pressure measured at 1 meter distance in free field

discover **ESYLINE**  
<https://esyline.dabpumps.com>





# ESYBOX

ELECTRONIC PRESSURIZATION SYSTEM



product design award

2013



## esybox

**ESYBOX** is DAB's new integrated system for pressurization in domestic and residential areas.

**ESYBOX** does not require any additional components for installation. It consists of a self-priming multistage pump, electronic inverter management, flow and pressure sensors, high-resolution swivel LCD display and an integrated 2 liter expansion tank. It can be installed both vertically and horizontally and even in tight spaces without a high air exchange.

The water-cooled engine, the hull protection in ABS with sound-absorbing function, the vibration damping feet and electronics make it an absolutely quiet (**43 dB**) and compact.

The wireless device facilitates the creation of pressurization units and connectivity with other DAB devices.

**Degree of protection** IP X 4

**Insulation class** F

**Pumped liquid** clean, free from solids or abrasive, non-aggressive, non-viscous, crystallized and not chemically neutral.

**Maximum liquid temperature** 40° C

**Maximum ambient temperature** 50° C

**Maximum suction depth**

self priming up to 8 metres.

**Maximum working pressure** 8 bar (800 kPa).

**D CONNECT**

PAG. 5

MODEL	CODE	ELECTRICAL DATA				HYDRAULIC DATA														DNA GAS	DNM GAS	WT. KG	Q.TY X PALLET
		P1 MAX		I MAX A	Q=m³/h																		
		kW	HP			VOLTAGE 50 - 60 Hz	0	0,6	1,2	1,8	2,4	3,0	3,6	4,2	4,8	5,4	6	6,6	7,2				
<b>ESYBOX</b>	60147200	1,55	2,1	10	0	0,6	1,2	1,8	2,4	3,0	3,6	4,2	4,8	5,4	6	6,6	7,2	1"	1"	27	6		
<b>ESYBOX - KIWA</b>	60184312	1,55	2,1	10	H (m)	65	63,5	61,5	59,5	57	53	48	41,5	35	27,5	19	10	2	1"	1"	27	6	

The KIWA version is provided with additional pressure sensor in the suction side that blocks the pump if the inlet pressure is below the set limit, compliant with the KIWA standards.

### APPLICATIONS



#### Esybox

Houses and small residential buildings up to 6 floors and a maximum of 9 apartments.\*



#### Esytwin

Small and large residential buildings up to 9 floors and a maximum of 17 apartments.\*

\*Indicative data. Please refer to the technical catalogue or DNA for correct sizing.

### CERTIFICATIONS



### SUITABLE FOR PUMPING WATER FROM:



WELLS DOWN TO 8 M DEEP

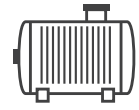

RAINWATER COLLECTION TANKS



TANKS



AQUEDUCT where permitted by law

SINGLE ESYBOX DIMENSIONS  
**57 x 27 x 35 cm**

SOUND PRESSURE\*\* **43 db(A)**



KIT DIMENSIONS  
**73 x 75 x 35 cm**



## KIT 2 ESYBOX

MODEL	CODE
<b>KIT 2 ESYBOX + ESYTWIN ***</b>	60170272

\*Compared to a traditional booster set in terms of medium usage conditions.

\*\* Sound pressure measured at 1 meter distance in free field

\*\*\* Unmounted provided

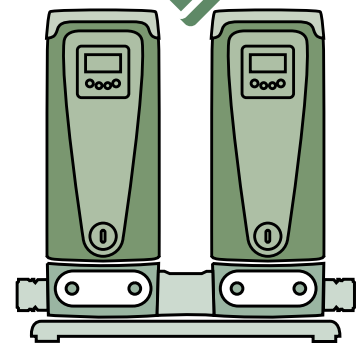
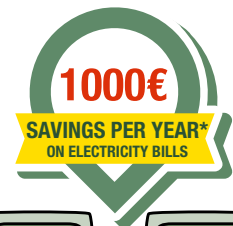
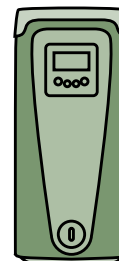

discover **esyline**  
<https://esyline.dabpumps.com>



# ESYLINE - ACCESSORIES

ELECTRONIC PRESSURIZATION SYSTEM

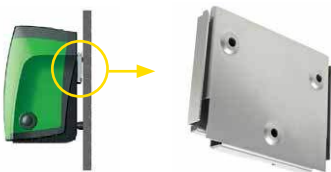
	MODEL	CODE
 <p><b>ALSO SUITABLE FOR ESYBOX MINI<sup>3</sup></b></p>	<p><b>KIT PIPE UNION 3PCS MF 1" WITH O-RING</b></p> <p>Kit consisting of 2 x 3-piece unions, to facilitate the connection of Esybox and Esybox mini<sup>3</sup> to the system</p>	SP00000630
 <p><b>ALSO SUITABLE FOR ESYBOX MINI<sup>3</sup></b></p>	<p><b>ESYWALL</b></p> <p>Kit complete with brackets, screws, dowels and two accessories for absorption of vibrations.</p>	60161442

KIT OUTDOOR	MODEL	CODE
 <p><b>FOR ESYBOX</b></p>	<p><b>ESYCOVER + ESYGRID</b></p> <p><b>KIT OUTDOOR ESYBOX</b></p> <p>Consisting of Esycover + Esygrid, which allows the installation of ESYBOX outside, protecting it from rain and the entry of foreign bodies.</p> <p><b>Vertical installation only.</b></p>	60185697
 <p><b>FOR ESYBOX MINI<sup>3</sup></b></p>	<p><b>ESYCOVER + ESYGRID</b></p> <p><b>KIT OUTDOOR ESYBOX MINI<sup>3</sup></b></p> <p>Consisting of Esycover + Esygrid, which allows the installation of ESYBOX MINI<sup>3</sup> outside, protecting it from rain and the entry of foreign bodies.</p> <p><b>Vertical installation only.</b></p>	60185698



## ESYGRID

### INSECT GRILLS

Suitable for vertical or horizontal installation.  
Suitable for both Esybox and Esybox mini<sup>3</sup>.

## ESYCOVER



### OUTSIDE INSTALLATION

Suitable for both Esybox and Esybox mini<sup>3</sup>.



# ESYLINE - ACCESSORIES

ELECTRONIC PRESSURIZATION SYSTEM

	MODEL	CODE
 <p><b>WRAS</b> APPROVED PRODUCT</p> <p>18 x 29 x 32 cm</p>	<h2>ESYDOCK</h2> <p>Thanks to the 4 plumbing configuration possibilities offers an 'installation even more rapid, easy and flexible. It is complete with all the interfaces required for connecting to the system. It incorporates anti vibration feet to ensure the same quietness as Esysbox.</p>	60147247
 <p><b>WRAS</b> APPROVED PRODUCT</p> <p>23 x 75 x 35 cm</p>	<h2>ESYTWIN</h2> <p>EsysTwin is the evolution of Esysdock, of which maintains all the benefits, for the creation of two groups of pumps. EsysTwin offers exceptional performance thanks to possibility of combined operation with a reduced size of 50% compared to any other equivalent traditional system.</p>	60160491
	<h3>ESYTWIN DOUBLE CONNECTION KIT</h3> <p>2" T suction and delivery manifold connection kit for the connection of 2 EsysTwin and the creation of boosters with up to 4 Esysbox. Suction and delivery manifold, each one consisting of: no. 2 x 1"1/4 Nipples no. 2 x 1"1/4 female -and 2" male reductions no. 3 x 2" 3-piece connectors no. 1 x 2" female T connector</p>	60184281



**DELIVERY AND SUCTION  
FITTING 1" 1/4**







**68 x 29 x 35 cm**



**KIT DIMENSIONS  
73 x 75 x 35 cm**

# ESYLINE - ACCESSORIES

ELECTRONIC PRESSURIZATION SYSTEM

	MODEL	CODE
 <p>* Esybox not included</p> <p>166 x 87 x 60 cm</p>	<h2>ESYTANK</h2> <p>Tank specially studied to better integrate with Esybox and equipped with:</p> <ul style="list-style-type: none"> <li>• Esydock (specially versioned) for quick connection.</li> <li>• suction hose with foot valve</li> <li>• filling valve from the water supply with float</li> <li>• Overflow</li> <li>• flow connection</li> <li>• preparation for ground mounting</li> <li>• inspection plug</li> </ul>	<p>ESYTANK TYPE AG OVERFLOW</p> <p>60161819</p>
	<p>Capacity 500 L with the possibility of expansion on 3 sides.</p>	<p>ESYTANK CAT5 TYPE AB OVERFLOW</p> <p>60186098</p>
	<h2>ESYTANK AUXILIARY CITERN</h2> <p>The ESYTANK AUXILIARY CITERN is supplied without any fittings or the ESYDOCK. The tank has a modular design to couple easily with other ESYTANK units, making the system expandable to the necessary capacity. It can be connected on three sides (at side and rear) using the ESYTANK TANK COUPLING KIT</p>	<p>60166063</p>
	<h2>ESYTANK COUPLING KIT</h2> <p>The ESYTANK COUPLING KIT is composed of a PVC sleeve with gasket (D.160 mm L=150), two PVC aligning pipes (D.50mm x L=60) and a connecting ring nut for a 2-pump option. It allows the connection of several ESYTANK units or between ESYTANK and ESYTANK AUXILIARY CITERN.</p>	<p>60166008</p>
	<h2>ESYTANK OPTIONAL DELIVERY KIT</h2> <p>Composed of a 1" PP pipe. It allows an auxiliary delivery for single tank systems or with the COUPLING KIT it allows several ESYTANK and ESYBOX systems to be linked together and to create pressure boosting units with several pumps and tanks.</p>	<p>60162079</p>

	MODEL	CODE
	<h2>KIT ESYLINK *</h2> <p>Esylink with power supplier and electric box.</p>	<p>60164735</p>

\* Provided to be wired

# NBB

## MOUNTING KIT FOR WATER COLLECTION AND PRESSURIZATION



### NBB is the solution for a domestic pressurizing system.

The basic concept is the modularity of its components such as: the NBB TANK KIT, the submerged or the surface pump, the inverter (in case the pump is without integrated electronics) and an assembling kit including the expansion tank (where this is not integrated in the pump itself). In all its different configuration the NBB is characterized by its compact dimension, great comfort and, in the version with inverter, also by an important aspect in terms of energy saving.

#### NBB TANK KIT consists of:

- 280 Lt. tank suitable for potable water compliant with the european norms EN1717 e EN13077
- Equipped with Filling valve and overflow valve
- Protection grid

Choosing the ADDITIONAL TANK KIT, consisting of a 280 liter tank, the junction elbow plus gasket and a belt, it's possible to double the capacity of the system. In addition to the NBB it is necessary to chose the assembling kit corresponding to the type of pump (or pump with inverter) to be utilized. The pump to be installed, as well as the inverter, are not included in the kit and must be order separately. The installation kit comprehends all the accessories necessary for the installation of the pump (or the inverter) to the NBB TANK KIT. For the PULSAR and EUROINOX installation kits also a 4 liter expansion tank is included.

#### Operating range

From 10 to 120 litres/min. with head up to 72 m.

#### Liquid temperature range

for domestic use: from 0°C to +35°C

#### Liquid quality requirements

Suitable for potable water pursuant to EN1717 and EN13077 European standards.

#### Maximum ambient temperature

+40°C

#### Max. operational pressure

8 bar (800 kPa) for surface pump configurations.

#### Max. inlet pressure

6 bar

#### Protection rating

IP44 for surface pumps.  
IP68 for submerged pumps.

#### Insulation class

F



PAG. 5

AD PLUS  
PAG. 25ACCESSORIES  
PAG. 111

MODEL	CODE
KIT NBB WRAS TANK 280 LITRE (INCL. GRID)	60149355
KIT ACTIVE FOR NBB	60116646
KIT EUROINOX FOR NBB	60123882
KIT PULSAR FOR NBB	60116638
KIT DIVERTRON FOR NBB	60123662
KIT ADDITIONAL TANK	60123556

Installation kit are designed for exclusive use with pump models specified below.

## TABLE OF SELECTION KIT NBB: A + B + C = NBB

A	B		C	
NBB TANK	PUMP MODEL	ACTIVE DRIVER PLUS	INSTALLATION KIT *	
 <p>60149355 - TANK KIT NBB 280 Litre (including protection grid)</p> <p>EXPANDABLE WITH:</p>  <p>60123556 AUXILIARY TANK KIT</p>	 <p>EUROINOX M</p> <p>EUROINOX T</p>	60149661 AD PLUS M/M 1.1	60123882 - EUROINOX INSTALLATION KIT <ul style="list-style-type: none"> <li>- Suction pipe</li> <li>- Fittings</li> <li>- Screws</li> <li>- Bracket for AD</li> <li>- Expansion tank 5 lt</li> <li>- Ball valve</li> </ul>	
		60169777 AD PLUS M/T 1.0		
	 <p>ACTIVE EI M</p>	60116646 - ACTIVE INSTALLATION KIT <ul style="list-style-type: none"> <li>- Suction pipe</li> <li>- Fittings</li> <li>- Screws</li> </ul>		
		 <p>104160070 - PULSAR 50/50 M-NA</p> <p>104160270 - PULSAR 40/80 M-NA</p> <p>104160480 - PULSAR 50/50 T-NA (3X230V)</p> <p>104160680 - PULSAR 40/80 T-NA (3X230V)</p>	60149661 AD M/M 1.1	60116638 - PULSAR INSTALLATION KIT <ul style="list-style-type: none"> <li>- Fittings</li> <li>- Check valve</li> <li>- Fixing bar pump</li> <li>- Bracket for AD</li> <li>- Ball valve</li> <li>- Screws</li> <li>- Expansion tank 5 lt</li> </ul>
			60169777 AD M/T 1.0	
60122626 - DIVERTRON 1200 M			60123662 - DIVERTRON INSTALLATION KIT <ul style="list-style-type: none"> <li>- Fittings</li> <li>- Fixing bar pump</li> <li>- Ball valve</li> <li>- Screws</li> </ul>	

\* All kits are supplied disassembled, provided with assembly instructions

# ACTIVE SWITCH

## RAIN WATER SYSTEM



Active Switch is a complete and pre-assembled system for using rainwater in one or two-family houses. The system comprises a recyclable polyethylene tank, an automatic pump Active EI 30/50 M series and a three-way automatic valve assembled on suction port of the pump.

The system has been designed to be wall-mounted. Supplied with wall bracket and float switch, with 20 mt. of cable, as a standard

### Working ambient temperature

min +5°C - max +40°C

**Max. Flow** 80 l/min

**Max. Head** 42,2 m

**Liquid temperature range** from +5°C up +35°C

**Max. Working pressure of the system**

6 bar (600kPa)

**Max. Pressure of main supply line**

4 bar (400kPa)

**Max. Height of working uses** 15 meters

**Potable water connector** 3/4"

**Pump suction and delivery ports** 1"

ACCESSORIES  
PAG. 111

MODEL	CODE	ELECTRICAL DATA				HYDRAULIC DATA										N° IMPELLERS	DNA PUMP	DNM PUMP	WT. KG	Q.TY x PALLET	
		VOLTAGE 50 Hz	P1 MAX KW	P2 NOMINAL		In A	Q=m³h	0	0,6	1,2	1,8	2,4	3,0	3,6	4,2						4,8
				kW	HP		Q=l/min	0	10	20	30	40	50	60	70						80
ACTIVE SWITCH 30/50 M	503150100	1x220-240 V ~	0,880	0,55	0,75	3,9	H (m)	42,2	40,2	38,2	36,2	33,8	30	24,8	19,5	14	4	1"	1"	18	4

# AQUAPROF

## RAIN WATER SYSTEM



Aquaprof is a complete and pre-assembled system for using rainwater in one or two-family houses. The system comprises a recyclable polyethylene console, a completely automatic electronic control unit, three-way automatic valve and electropump Euroinox 30/50 M or Euroinox 40/50 M series. Supplied with wall bracket as a standard and float switch with 20 mt. of cable for Aquaprof Basic version, or probe sensor level with 20 mt. of cable for Aquaprof TOP.

**Protection Level** IP 42

**Working ambient temperature**

min. +5°C - max. +40°C

**Max. Flow** 80 lt/min.

**Max. Head** 42,2 m. (Aquaprof 30/50)

57,7 m. (Aquaprof 40/50)

**Liquid temperature range**

from +5°C up to +35°C

**Max. Working pressure of the system**

6 bar (600kPa)

**Max. Pressure of main supply line**

4 bar (400kPa)

**Max. Height of working uses** 15 meters

**Potable water connector** 3/4"

**Pump suction and delivery ports** 1"

ACCESSORIES  
PAG. 111

MODEL	CODE	ELECTRICAL DATA				HYDRAULIC DATA										N° IMPELLERS	DNA GAS	DNM GAS	WT. KG	Q.TY x PALLET		
		VOLTAGE 50 Hz	P1 MAX KW	P2 NOMINAL		In A	Q=m³h	0	0,6	1,2	1,8	2,4	3,0	3,3	3,6						4,2	4,8
				kW	HP		Q=l/min	0	10	20	30	40	50	55	60						70	80
AQUAPROF BASIC 30/50	503150200	1x220-240 V ~	0,88	0,55	0,75	3,9	H (m)	42,2	40,2	38,2	36,2	33,8	30	27,5	24,8	19,5	14	3	1"	1"	28	3
AQUAPROF BASIC 40/50	503150210	1x220-240 V ~	1,2	0,75	1	5,3		57,7	55,3	52,8	50,1	47,1	42,7	39,5	35,8	28	19,2	4	1"	1"	32	3
AQUAPROF TOP 30/50	503150300	1x220-240 V ~	0,88	0,55	0,75	3,9		42,2	40,2	38,2	36,2	33,8	30	27,5	24,8	19,5	14	3	1"	1"	28	3
AQUAPROF TOP 40/50	503150310	1x220-240 V ~	1,2	0,75	1	5,3		57,7	55,3	52,8	50,1	47,1	42,7	39,5	35,8	28	19,2	4	1"	1"	32	3

# EBOX

## ELECTRONIC PROTECTION AND CONTROL PANEL



Ebox plus D



Ebox basic

**Ebox plus** is an electronic control panel for the protection and automatic operation of one or two submersible pumps or pressurizing both single-phase and three-phase, installed in domestic, civil and industrial environments.

**Ebox basic** is an electronic control panel for the protection and automatic operation of one or two electronic submersible pumps or single-phase pressurization for domestic applications.

### Nominal tension of power supply

**Ebox plus** 1x 230 V / 3 x 230 V - 3 x 400 V  
(automatic selection)

**Ebox basic** 1x 230 V

**Frequency** 50 - 60 Hz

### Maximum use of power

**Ebox plus** 5,5 kWatt + 5,5 kWatt

**Ebox basic** 2,2 kWatt + 2,2 kWatt

**Maximum use of current** 12 A + 12 A

### Starting capacitor

KIT supplied as an accessory

### Limits of use ambient temperature

-10° C + 40° C

### Limits of storage temperature

-25° C + 55° C

**Relative humidity to the air** 90% a 20° C

**Max altitude max** 1000 s.l.m.

**Degree of protection** IP 55

Reference standard for the construction of the panels EN 60335-1

# ebox

**D+CONNECT** PAG. 5

MODEL	CODE	VOLTAGE 50 HZ	STARTING	P2 NOMINAL		MAX CURRENT A	DISPLAY
				kW x2	HP x2		
<b>EBOX BASIC 230/50-60</b>	60163214	1 X 230 V	DIRECT	2,2	3	12+12	-
<b>EBOX PLUS 230-400V/50-60</b>	60163215	1 X 230 V	DIRECT	2,2	3	12+12	-
		3 X 230 V		3	4		
		3 X 400 V		5,5	7,5		
<b>EBOX BASIC D 230/50-60</b>	60163216	1 X 230 V	DIRECT	2,2	3	12+12	•
<b>EBOX PLUS D 230-400V/50-60</b>	60163217	1 X 230 V	DIRECT	2,2	3	12+12	•
		3 X 230 V		3	4		
		3 X 400 V		5,5	7,5		

## DISPLAY



Thanks to the configuration wizard, installation of display versions is much simpler. Management is also much easier, thanks to the status always being visible and to a range of additional functions, such as the anti-seizing of drainage pumps, the alarm log, the language selection, and the password protected settings.

# SMART PRESS

ON/OFF CONTROLLER



SMART PRESS is an ON/OFF electronic device designed to switch the pump ON/OFF without using an expansion vessel. The device protects the pump against dry running without using level probes or float switch.

It has an adjustable cut-in pressure and even with a high flow the pressure losses are small. All the SMART PRESS models have a MANUAL AND AUTOMATIC RESTART.

## SMART PRESS

MODEL	CODE	SETTING PRESSURE bar	DNA GAS	DNM GAS	WEIGHT Kg	Q.TY x PALLET
SMART PRESS WG 1,5 - AUTOM. RESET - WITHOUT CABLE	60114808	1,5	1" M	1" ¼ F	1,3	100
SMART PRESS WG 1,5 - AUTOM. RESET - WITH CABLE	60113308	1,5	1" M	1" ¼ F	1,6	100
SMART PRESS WG 3.0 - AUTOM. RESET - WITHOUT CABLE	60114809	1,5	1" M	1" ¼ F	1,3	100
SMART PRESS WG 3.0 - AUTOM. RESET. - WITH CABLE	60113922	1,5	1" M	1" ¼ F	1,6	100



# MULTISTAGE CENTRIFUGAL AND SELF - PRIMING PUMPS ACCESSORIES

---



# ACCESSORIES



## CENTRIFUGAL AND SELF PRIMING PUMPS

EXPANSION VESSELS	DESCRIPTION	CODE
 <p>100/310/450 LITRE V      20/60 LITRE H      2/8/18 LITRE V</p>	2 LT. TANK 10 BAR V - G	60141865
	8 LT. TANK 10 BAR V - G	60141866
	18 LT. TANK 10 BAR V - G	60141867
	18 LT. TANK 16 BAR V - G	60141868
	20 LT. TANK 10 BAR H - G	60141869
	60 LT. TANK 10 BAR H - G	60141870
	100 LT. TANK 10 BAR V - G	60141871
	310 LT. TANK 10 BAR V - G	60141872
	450 LT. TANK 10 BAR V - G	60141873

ACQUABOX ASSEMBLY KIT	DESCRIPTION	CODE
	FLEXIBLE PIPE KIT AQUAJET RED VESSEL 20L	547120530
	FLEXIBLE PIPE KIT AQUAJETINOX RED VESSEL 20L	547120510
	FLEXIBLE PIPE KIT AQUAJET WHITE VESSEL 20L	60126040
	FLEXIBLE PIPE KIT AQUAJETINOX WHITE VESSEL 20L / RED VESSEL 60L	547120570



ACQUABOX ASSEMBLY KIT	DESCRIPTION	CODE
	DIAPH. FOR AQUABOX V 8 LT. BUTYL	002139828
	DIAPH. FOR AQUABOX "V" 20LT. - 16 BAR BUTYL	002139833
	DIAPH. FOR AQUABOX 19-20 LT. BUTYL	002139831

MANOMETERS	DESCRIPTION	CODE
	AXIAL PRESS. GAUGE 6 BAR D.50, 1/4" COUPL.	002125051
	AXIAL PRESS. GAUGE 12 BAR D.63, 1/4" COUPL.	002126007
	RADIAL PRESS. GAUGE 12 BAR D.63, 1/4" COUPL.	002126037

PRESSURE SWITCH	DESCRIPTION	CODE
	PRESS. SWITCH 6 BAR	002716710
	PRESS. SWITCH 6 BAR - XMP	60110618
	PRESS. SWITCH 12 BAR - XMP	60110619
	MIN. PRESS. SWITCH XMX A06L 1/4" F IP 43	002717002

# ACCESSORIES

## CENTRIFUGAL AND SELF PRIMING PUMPS

CONNECTORS	DESCRIPTION	CODE
	3 - WAY BRASS CONNECTOR 1"	167320100
	5 - WAY BRASS CONNECTOR 1"	60110862

FOOT VALVES	DESCRIPTION	CODE
 FOOT VALVE 3/4"	FOOT VALVE 3/4"	002130903
	FOOT VALVE 1"	002130904
	FOOT VALVE 1 1/4"	002130905

NON-RETURN VALVES	DESCRIPTION	CODE
 NON-RETURN VALVE 3/4"	NON-RETURN VALVE 3/4"	002130063
	NON-RETURN VALVE 1"	002130064
	NON-RETURN VALVE 1 1/4"	002130065
	NON-RETURN VALVE 1 1/2"	002130066
	NON-RETURN VALVE 2"	002130007

CONTROL-D	DESCRIPTION	CODE
	CONTROL-D 1,2 BAR 1.5 KW WITHOUT CABLE	60180503
	CONTROL-D 1,5 BAR 1.5 KW WITHOUT CABLE	60180505
	CONTROL-D 2,2 BAR 1.5 KW WITHOUT CABLE	60180506
	CONTROL-D 1,2 BAR 1.5 KW WITH CABLE	60180507
	CONTROL-D 1,5 BAR 1.5 KW WITH CABLE	60180508
	CONTROL-D 2,2 BAR 1.5 KW WITH CABLE	60180509
	CONTROL-D SET 1.5 KW WITHOUT CABLE	60180510
	CONTROL-D SET 1.5 KW WITH CABLE	60180511
	CONTROL -D GSET 1.5 KW WITHOUT CABLE	60180931

# ACCESSORIES

## CENTRIFUGAL AND SELF PRIMING PUMPS

FLEXIBLE PIPE	DESCRIPTION	CODE
	<b>ACTIVE FLEXIBLE PIPE FOR HYDRAULIC CONNECTION</b>	147120790

TANK KIT BOOSTER SILENT	DESCRIPTION	CODE
	<p><b>3-WAY FITTING</b></p> <p><b>STRAIGHT FITTING</b></p> <p><b>2 LT TANK:</b></p> <ul style="list-style-type: none"> <li>· diaphragm high-grade butyl membrane</li> <li>· Patented stainless steel water connection</li> <li>· Epoxy primed paint finish</li> <li>· Single diaphragm design</li> <li>· Virgin polypropylene liner</li> <li>· Leak free o-ring sealed air valve cap</li> </ul>	60147112



## SWIMMING POOL PUMPS



**ESWIM / EPRO**  
ELECTRONIC SWIMMING POOL PUMP

**NEW  
MODELS**

BA PAG. 116



**EUROSWIM**  
SWIMMING POOL CENTRIFUGAL PUMPS

BA PAG. 117



**EUROPRO HIGH FLOW**  
SWIMMING POOL CENTRIFUGAL PUMPS

BA PAG. 118



**PREFILTER RANGE**  
CAST IRON PREFILTER FOR MONOBLOC NORMALISED  
CENTRIFUGAL ELECTROPUMPS

AP PAG. 119



**EUROCOVER**  
SWIMMING POOL SUBMERSIBLE PUMPS

BB PAG. 126



**JETCOM SP - EUROCOM SP**  
SWIMMING POOL CENTRIFUGAL PUMPS

B9 B8 PAG. 126

## SALT WATER PUMPS



**MULTI 4 SW**  
SELF-PRIMING HORIZONTAL MULTISTAGE PUMPS

B8 PAG. 127



**NOVA SALT W**  
SUBMERSIBLE PUMPS

A7 PAG. 127

## POND PUMPS



**NOVAPOND**  
SUBMERSIBLE PUMPS

D8 PAG. 128



## ACCESSORIES

PAG. 129

# ESWIM - EPRO

ELECTRONIC SWIMMING POOL PUMP



NEW MODELS

ESWIM



EPRO



Electronic pumps with variable frequency drive for swimming pools and fish farms suitable for filtering salt or chlorine water in residential building service and commercial building service.

The pumps are quiet, programmable and equipped with a large inspectable pre-filter.

ESwim 150 and ESwim 150 SVRS have a 12-pin control card which makes them compatible with any control panel, both analog and digital. Lid of the pre-filter in transparent polycarbonate and in antioxidant material for an easy visual inspection. Permanent magnet synchronous motor, brushless. The motor is cooled by the pumped liquid, it is without cooling fan so the noise level is only 45 dB. Bayonet lid closure for ESwim, lid closure with wing screws for EPro. It is possible to remote control the pumps via 0-10 V, 4-20 mA and PWM signal.

Thanks to the variable frequency drive, the pumps can operate at constant speed or with constant flow (without the use of sensors) to optimize performance and minimize energy consumption. The control panel has 4 buttons with 8 programmable speeds and status and alarm signaling LEDs. There is a menu for weekly and seasonal programming. The SVRS version is equipped with a software function that disables pump suction if an obstruction is detected. "SVRS" is an acronym that means Safety Vacuum Release Systems.



## Flow rate maximum

150 versions: 32 m<sup>3</sup>/h  
300 versions: 42,6 m<sup>3</sup>/h

## Head up to

150 versions: 16 m  
300 versions: 26 m

**Type of pumped liquid** Clean or slightly dirty water with suspended solid bodies, long fibers; particularly aggressive water with high percentages of chlorine / bromine and PHMB (Polyhexamethylene Biguanide) or water treated with chlorine electrolysis process

**Maximum % of glycol** 6,5 - 8,4

**Max. supported liquid temperature** +40°C

**Maximum ambient temperature** +50°C

**Maximum operating pressure bar / kPa**

150 versions: 2,5 bar  
300 versions: 2,8 bar

**Class of protection**

150 versions: IP 55  
300 versions: IP 56

**Motor insulation class** F

**Impeller/s material** Techopolimer



NSF

Certified to  
NSF/ANSI Standard 50

40 dB

ACCESSORIES  
PAG. 129

## ESWIM 150 - EPRO 150

MODEL	CODE	ELECTRICAL DATA					HYDRAULIC DATA											DNA GAS	DNM GAS	WEIGHT KG	Q.TY x PALLET							
		VOLTAGE 50 Hz	P1 MAX W	P2 NOMINAL		In A	Q=m <sup>3</sup> /h	0	6	12	18	21	24	27	30	Q=l/min	0					100	200	300	350	400	450	500
				kW	HP		H (m)	15,9	15,7	14,4	12,2	10,9	9,4	7,9	6,3		2"					2"	19	8				
ESWIM 150	60194426	230 V	1,25	1,1	1,5	5,6	H (m)	15,9	15,7	14,4	12,2	10,9	9,4	7,9	6,3	2"	2"	19	8									
EPRO 150	60194429	230 V	1,25	1,1	1,5	5,6	H (m)	15,9	15,7	14,4	12,2	10,9	9,4	7,9	6,3	2"	2"	19	8									

## ESWIM 300 - EPRO 300

MODEL	CODE	ELECTRICAL DATA					HYDRAULIC DATA														DNA GAS	DNM GAS	WEIGHT KG	Q.TY x PALLET								
		VOLTAGE 50 Hz	P1 MAX W	P2 NOMINAL		In A	Q=m <sup>3</sup> /h	0	5	10	15	20	25	30	35	40	42,6	Q=l/min	0	83					166	250	333	416	500	583	666	710
				kW	HP		H (m)	26	25,4	24,8	23,2	20,6	17,4	14,4	11,5	7,8	6		2"	2"					21,3	6						
ESWIM 300	60174704	230 V	2,25	1,9	2,6	10	H (m)	26	25,4	24,8	23,2	20,6	17,4	14,4	11,5	7,8	6	2"	2"	21,3	6											
EPRO 300	60198406	230 V	2,25	1,9	2,6	10	H (m)	26	25,4	24,8	23,2	20,6	17,4	14,4	11,5	7,8	6	2"	2"	21,3	6											

## SVRS VERSION

The SVRS software (Safety Vacuum Release Systems) disables the suction capacity of the pump to free a body or object trapped in the suction outlet, guaranteeing peace of mind and ease of use.

MODEL	CODE
ESWIM 150 SVRS	60194427

# EUROSWIM

## SWIMMING POOL CENTRIFUGAL PUMPS



High efficiency self-priming centrifugal pumps with built-in large capacity prefilter. Extremely quiet running and great reliability, developed for water circulation and filtration in domestic and residential swimming pools. Suitable also for special applications that call for handling of aggressive liquids, in fish farms, agriculture and industry. Pump body in fibreglass reinforced technopolymer. Strainer cover in clear antioxidant polycarbonate to guarantee constant visibility through time. Nylon strainer. Impeller in fibreglass-reinforced technopolymer. Mechanical seal in carbon / alumina / NBR / AISI 316. Pump body O-rings in NBR, threaded fasteners and reinforcing rings in AISI 304. Butterfly drain plugs that can be removed and refitted without tools.

Asynchronous continuous duty 2-pole motor (S1) with generous range of power ratings from 0.5 HP to 3 HP, single phase and three-phase (see technical specifications). Motor casing in die cast aluminium with electrophoretic surface treatment to prevent oxidation even in aggressive environmental conditions. Baseplate supplied as standard with rubber mounts to reduce vibration transmission.

Single phase version with integral thermal and overcurrent protection and permanent split capacitor (PSC), assembled inside the terminal box for all versions.

**Motor and terminal box protection rating** IPX5

**Insulation class** F

**Ball bearings**

water-proof, sealed, resistant to water and humidity. Motor construction to EN 60335-2-41 standards

**Standard voltage** Single phase 220-240V 50Hz  
Three-phase 230/400V 50Hz

**Operating range**

up to 42 m<sup>3</sup>/h with pressure head of up to 22 m

**Pumped fluid** clean water or water slightly contaminated with suspended particulate, long fibre; highly aggressive water with high percentage contents of chlorine/bromine and PHMB (Polyhexamethylene Biguanide) or water treated with chlorine electrolytic process.

**Liquid temperature range** up to 60°C

**Maximum ambient temperature** +50°C

**Maximum operating pressure** 2,5 bar

**Installation** fixed or portable in horizontal position

**Special executions on request**

alternative voltages and/or frequencies

**Fittings on request** 2"/50 - 63 kit (two fittings + O-ring - see "Accessories")

**Reference standard** IEC - 60364

IE3 ≥ 0,75 kW

IE2 ≥ 0,75 kW EXTRA EU

60 dB

ACCESSORIES  
PAG. 129

MODEL	CODE	ELECTRICAL DATA						HYDRAULIC DATA														DNA	DNM	MAX NOISE LEVEL dB (A)	WT. KG	Q.TY x PALLET	
		VOLTAGE 50 Hz	P1 MAX W	P2 NOMINAL		In A	MOTOR TYPE	Q=m <sup>3</sup> /h	0	3	6	9	12	18	21	24	30	36	42								
EUROSWIM 50 M	60118028	1x220-240V ~	900	0,33	0,5	4,2	-	H (m)	12,0	11,7	11,2	10,5	9,3	5,3							2" F	2" F	53	16	8		
EUROSWIM 75 M	60118029	1x220-240V ~	1000	0,5	0,75	5	-		13,8	13,5	13,1	12,4	11,1	7,5	5							2" F	2" F	56	16,5	8	
EUROSWIM 75 T	60179393	3x230-400V ~	950	0,5	0,75	3,5 / 2	IE3		13,8	13,5	13,1	12,4	11,1	7,5	5							2" F	2" F	56	16,5	8	
EUROSWIM 100 M	60118030	1x220-240V ~	1300	0,75	1	6,3	-		15,4	15,4	15	14,2	13,1	10,0	7,8	5,6						2" F	2" F	57	17	8	
EUROSWIM 100 T	60179412	3x230-400V ~	1200	0,75	1	4 / 2,4	IE3		15,4	15,4	15	14,2	13,1	10,0	7,8	5,6						2" F	2" F	57	17	8	
EUROSWIM 150 M	60118032	1x220-240V ~	1600	1,1	1,5	7	-		16,2	15,9	15,4	14,9	14,2	12,4	11,1	9,3	5,3					2" F	2" F	59	22	6	
EUROSWIM 150 T	60179850	3x230-400V ~	1500	1,1	1,5	6,5 / 3,7	IE3		16,2	15,6	15,2	14,6	13,9	12,4	11,1	9,3	5,3					2" F	2" F	59	22	6	
EUROSWIM 200 M	60118033	1x220-240V ~	1900	1,5	2	8,6	-		18,6	18,2	17,7	17,1	16,5	15,0	14,1	12,8	9,0	4				2" F	2" F	62	24	6	
EUROSWIM 200 T	60179849	3x230-400V ~	1900	1,5	2	7,2 / 4	IE3		18,6	18,2	17,7	17,1	16,5	15,0	14,1	12,8	9,0	4				2" F	2" F	62	22	6	
EUROSWIM 300 M	60122213	1x220-240V ~	2800	2,2	3	12	-		22,0	21,9	21,7	21,3	20,8	19,6	18,9	18,1	15,9	12,5	8,6			2" F	2" F	64	24,5	6	
EUROSWIM 300 T	60179851	3x230-400V ~	2800	2,2	3	8,7 / 5	IE3		22,0	21,9	21,7	21,3	20,8	19,6	18,9	18,1	15,9	12,5	8,6			2" F	2" F	64	25	6	
EUROSWIM 75 T	60145192	3x230-400V ~	950	0,5	0,75	3,5 / 2	IE2		H (m)	13,8	13,5	13,1	12,4	11,1	7,5	5						2" F	2" F	56	16,5	8	
EUROSWIM 100 T	60145258	3x230-400V ~	1200	0,75	1	4 / 2,4				15,4	15,4	15	14,2	13,1	10,0	7,8	5,6						2" F	2" F	57	17	8
EUROSWIM 150 T	60146030	3x230-400V ~	1500	1,1	1,5	6,5 / 3,7				16,2	15,6	15,2	14,6	13,9	12,4	11,1	9,3	5,3					2" F	2" F	59	22	6
EUROSWIM 200 T	60146035	3x230-400V ~	1900	1,5	2	7,2 / 4		18,6		18,2	17,7	17,1	16,5	15,0	14,1	12,8	9,0	4					2" F	2" F	62	22	6
EUROSWIM 300 T	60146024	3x230-400V ~	2800	2,2	3	8,7 / 5		22,0		21,9	21,7	21,3	20,8	19,6	18,9	18,1	15,9	12,5	8,6				2" F	2" F	64	25	6

# EUROPRO HIGH FLOW

## SWIMMING POOL CENTRIFUGAL PUMPS



Self-priming, high-performance centrifugal pumps, with built-in large capacity prefilter. 2 or 4 pole motor completely isolated from the water. Extremely quiet and highly reliable, developed for the circulation and filtration in large swimming pool filtration systems. Also suitable for particular applications that require handling of **seawater** thanks to the mechanical seal made of AISI 316. Prefilter body, pump body, volute, volute cover and pump body lid are made of polypropylene, resistant to chemical products found in swimming pools and reinforced with fiber glass. Prefilter basket made of polyethylene. Prefilter lid made of transparent polycarbonate with four knobs locking system. Closed asynchronous motor with external ventilation with 2 or 4 poles depending on the model, with a wide capacity range from 3 to 15 Hp. Terminal box with IP55 Degree of protection.

### Operating range

Up to 190 m<sup>3</sup>/h with head up to 22 m

### Standard Voltage

3 x 230-400V 50 Hz fino a 4 Kw  
3 x 400-690V 50 Hz oltre i 4 KW

### Insulation class F

**Temperature range of the liquid** up to 40°C

**Pumped Liquid** clean or slightly dirty water or a little aggressive (PolyHexamethylene Biguanide) or water treated with chlorine electrolysis process.

**Maximum ambient temperature** 40°C

**Installation** in horizontal position

**Special executions on request**  
other frequencies and/or voltages

IE3 ≥ 0,75 kW

ACCESSORIES  
PAG. 129

MODEL	CODE	ELECTRICAL DATA							HYDRAULIC DATA														DNA GAS	DNM GAS	KG	Q.TY x PALLET	
		VOLTAGE 50 Hz	P1 MAX W	P2 NOM. kW HP		N. rpm	In A			Q=m <sup>3</sup> /h	0	20	60	80	90	120	140	160	170	180	190	195					
									Q=l/min	0	333	1000	1333	1500	2000	2333	2666	2833	3000	3166	3250						
EUROPRO 350 T	60169120	3x230-400V	2,97	2,2	3	1450	9,4	5,3	-	H (m)	14,7	13	6,3	2,1									110	110	42,5	3	
EUROPRO 400 T	60169121	3x230-400V	3,83	3	4	1450	12,5	6,9	-		16,5	14,9	8,5	4	1,6									110	110	44,5	3
EUROPRO 550 T - BR*	60169143	3x230-400V	5,54	4	5,5	1450	15,3	8,8	-		14	13,5	11,8	10,4	9,5	6,3	4,1							110	110	53,5	2
EUROPRO 550 T	60169123	3x230-400V	5,54	4	5,5	1450	15,3	8,8	-		14	13,5	11,8	10,4	9,5	6,3	4,1							110	110	53,5	2
EUROPRO 750 T - BR*	60169144	3x400-690V	6,85	5,5	7,5	1450	-	12	7		16,2	15,6	13,8	12,4	11,5	8,65	6,47	3,5						110	110	66	2
EUROPRO 750 T	60169124	3x400-690V	6,85	5,5	7,5	1450	-	12	7		16,2	15,6	13,8	12,4	11,5	8,65	6,47	3,5						110	110	66	2
EUROPRO 1000 T - BR*	60169145	3x400-690V	8,26	7,5	10	1450	-	16,2	9,6		17,6	17	15,4	14,2	13,5	10,8	8,6	6,1	4,7					110	110	76	2
EUROPRO 1000 T	60169139	3x400-690V	8,26	7,5	10	1450	-	16,2	9,6		17,6	17	15,4	14,2	13,5	10,8	8,6	6,1	4,7					110	110	76	2
EUROPRO 1250 T	60169140	3x400-690V	13,74	9,2	12,5	2850	-	17,9	10,1		22,4	21,5	19,4	18,1	17,4	14,7	12,6	10,3	9	7,6	5,5			110	110	84,5	2
EUROPRO 1500 T	60169142	3x400-690V	15,73	11	15	2850	-	19,9	11		25,5	24,5	22,4	21,3	20,6	17,4	14,8	12,1	10,6	9,1	7,4	6		110	110	85,5	2

\* BRONZE IMPELLER



# CAST IRON PREFILTERS

FOR MONOBLOC NORMALISED CENTRIFUGAL ELECTROPUMPS



PREFILTER



PREFILTER + PUMPS

New range of cast iron prefilters complying with DIN 2501, with connection from DN 65 to DN 200. They are provided with 3 or 4 closing knobs depending on the model, to ensure perfect sealing of the cap. Vessel and prefilter cap in cast iron, basket in stainless steel AISI 316.

The new range of prefilters allows the use of monobloc normalised centrifugal pumps series NKM-G/NKP-G, from DN 40 to DN 150, for water circulation in large filtration systems. The same filters can be used with normalised base pumps with joint (KDN) or with inverter MCE.

Monobloc centrifugal pumps with joint to which a prefilter has been applied on suction to make them ideal for water circulation in large filtration systems.

**The pump and prefilter are sold separately.**

Single-stage spiral body in cast iron complying with DIN-EN 733 (ex DIN2455), cast iron support, flanges complying with DIN 2533. Cast iron impeller, closed and dynamically balanced with compensation of the axial thrust through balancing holes. Pump shaft in stainless steel AISI 304, **carbon /silicon carbide mechanical seal with O-Rings in Viton.**

Closed type asynchronous motor with external ventilation, constructive shape B3/B5, with two poles for NKP and four poles for NKM. Vessel and prefilter cap in cast iron, basket in stainless steel AISI 316.

**Rotation speed** 1450-2900 1/min

**Operating range**

from 1 to 440 m<sup>3</sup>/h with head up to 24 metres.

**Pumped fluid** clean water or slightly dirty or slightly aggressive, on condition that in the last case the compatibility of the materials of which the pump is made is demonstrated, and that the power of the motor installed is suitable for the specific weight and viscosity of the fluid.

**Range of temperature of the fluid**  
from -10°C to +140°C

**Maximum environment temperature** +40°C

**Installation** in horizontal position

**TOP Version**

bronze impeller and cataphoresis treatment

## PREFILTERS

MODEL	CODE	DN	Kg	Volume Lts
PREFILTER 65/65	60164699	65	38,5	18
PREFILTER 80/80	60164700	80	39	18
PREFILTER 100/100	60164701	100	40,5	18
PREFILTER 125/125	60164702	125	41	18
PREFILTER 150/150	60164703	150	71	42
PREFILTER 200/200	60164704	200	72	42

NOTE: PUMP AND PREFILTER ARE SOLD SEPARATELY  
For further information, contact our sales network.

## PREFILTER FIXING KIT

MODEL	CODE
PREFILTER FIXING KIT DN 65	60166309
PREFILTER FIXING KIT DN 80-100-125	60166312
PREFILTER FIXING KIT DN150-200	60166313

# CAST IRON PREFILTERS

FOR MONOBLOC NORMALISED CENTRIFUGAL ELECTROPUMPS



**IE3 ≥ 0,75 kW**

## NKM-G - 4 POLES - BASIC VERSION

Cast Iron Impeller and mechanical seal with O-Rings in Viton

MODEL *	CODE	ELECTRICAL DATA				HYDRAULIC DATA														DNA	DNM	KG					
		VOLTAGE 50 Hz	P2 NOMIN.		In (A)		Q=m³h		0	6	12	18	24	30	36	42	48	54	60				66	72	78		
			kW	HP	230V	400V	Q=l/min	0	100	200	300	400	500	600	700	800	900	1000	1100				1200	1300			
NKM-G 40-200/200/A/BAQV/ 1,1 /4	1D2317B4W	3 x 230 - 400 V ~	1.1	1.5	4,68	2,7	H (m)	12.5	12.5	12.3	11.2	9.7	7.7											65	40	54	
NKM-G 40-200/219/A/BAQV/ 1,5 /4	1D2317B5W	3 x 230 - 400 V ~	1.5	2	6,24	3,6		15.6	15.6	15.3	14.7	13.4	11.8	9.8											65	40	54
NKM-G 40-250/245/A/BAQV/ 2,2 /4	1D2417B6W	3 x 230 - 400 V ~	2.2	3	8,75	5,05		20.6	20.5	20.1	19.2	17.8	16												65	40	75
NKM-G 50-160/177/A/BAQV/ 1,5 /4	1D3217B5W	3 x 230 - 400 V ~	1.5	2	6,24	3,6		10.7		10.7	10.7	10.5	10.2	9.8	9.2	8.3									65	50	46
NKM-G 50-200/210/A/BAQV/ 2,2 /4	1D3317B6W	3 x 230 - 400 V ~	2.2	3	8,75	5,05		15.3		15.3	15.2	14.8	14	13.3	12.1	10.8	9.4								65	50	69
NKM-G 50-200/219/A/BAQV/ 3/4	1D3317B7X	3 x 400 V ~	3	4	-	6,25		16.8		16.8	16.5	16.1	15.5	14.6	13.6	12.4	10.9								65	50	65
NKM-G 50-250/263/A/BAQV/ 4/4	1D3417B8X	3 x 400 V ~	4	5.5	-	7,95		23.8		23.8	23.8	23.4	22.7	21.6	20.4	19	17.1								65	50	79
NKM-G 65-200/210/A/BAQV/ 3/4	1D4317B7X	3 x 400 V ~	3	4	-	6,25		15.3				15.2	15.2	15.1	14.6	14.1	13.5	12.9	12.2	11.3				80	65	72	
NKM-G 65-200/219/A/BAQV/ 4/4	1D4317B8X	3 x 400 V ~	4	5.5	-	7,95		17				17	16.9	16.8	16.4	16.2	15.8	15.2	14.3	13.8	12.6				80	65	77
NKM-G 65-250/263/A/BAQV/ 5,5 /4	1D4417B9X	3 x 400 V ~	5.5	7.5	-	10,6		24.1				23.8	23.6	23.3	22.8	22.3	21.5	20.8	19.7	18.6	17.3				80	65	165

MODEL *	CODE	ELECTRICAL DATA				HYDRAULIC DATA														DNA	DNM	KG		
		VOLTAGE 50 Hz	P2 NOMIN.		In (A)		Q=m³h		0	42	48	54	60	66	72	78	84	90	102				114	120
			kW	HP	230V	400V	Q=l/min	0	700	800	900	1000	1100	1200	1300	1400	1500	1700	1900				2000	
NKM-G 80-200/200/A/BAQV/ 4/4	1D5317B8X	3 x 400 V ~	4	5.5	-	7,95	H (m)	13.2	13.1	13	12.9	12.8	12.7	12.4	12	11.7	11.3	10.4	9.3	8.7	100	80	99	
NKM-G 80-200/222/A/BAQV/ 5,5 /4	1D5317B9X	3 x 400 V ~	5.5	7.5	-	10,6		16.6	16.5	16.5	16.4	16.2	16.1	16	15.7	15.4	15	14.3	13.3	12.7	100	80	153	
NKM-G 80-250/240/A/BAQV/7,5/4	1D5417BAX	3 x 400 V ~	7.5	10	-	14,6		20.4	20.3	20.3	20.2	20.1	20	19.9	19.8	19.5	19	18	16.7	16	100	80	153	
NKM-G 80-250/270/A/BAQV/11/4	1D5417BBX	3 x 400 V ~	11	15	-	20,5		25.6	25.5	25.5	25.4	25.1	25	24.8	24.6	24.2	24	23	21.5	21	100	80	205	

MODEL *	CODE	ELECTRICAL DATA				HYDRAULIC DATA														DNA	DNM	KG		
		VOLTAGE 50 Hz	P2 NOMIN.		In (A)		Q=m³h		0	60	66	72	78	84	90	102	114	120	150				180	210
			kW	HP	230V	400V	Q=l/min	0	1000	1100	1200	1300	1400	1500	1700	1900	2000	2500	3000				3500	
NKM-G100-200/200/A/BAQV/5.5 /4	1D6317B9X	3 x 400 V ~	5.5	7.5	-	10,6	H (m)	12.7	12.6	12.6	12.5	12.5	12.4	12.3	12	11.5	11.4	10.1	8.5		125	100	166	
NKM-G 100-200/214/A/BAQV/7.5/4	1D6317BAX	3 x 400 V ~	7.5	10	-	14,6		15.6	15.4	15.4	15.3	15.2	15.1	15	14.7	14.5	14.3	13.3	11.6	9.8	125	100	149	
NKM-G 100-250/250/A/BAQV/11/4	1D6417BBX	3 x 400 V ~	11	15	-	20,5		21.1	21	21	21	21	21	21	21	20.9	20	19.8	18	16		125	100	213

MODEL *	CODE	ELECTRICAL DATA				HYDRAULIC DATA														DNA	DNM	KG			
		VOLTAGE 50 Hz	P2 NOMIN.		In (A)		Q=m³h		0	102	114	120	150	180	210	240	270	300	330				360	390	420
			kW	HP	230V	400V	Q=l/min	0	1700	1900	2000	2500	3000	3500	4000	4500	5000	5500	6000				6500	7000	
NKM-G 125-250/243/A/BAQV/15/4	1D7417BCX	3 x 400 V ~	15	20	-	28	H (m)	19.5	19.3	19.3	19.2	19.2	18.7	17.8	16.8	15.5	14.1	12.5	10.9			150	125	274	
NKM-G 125-250/256/A/BAQV/18,5/4	1D7417BDX	3 x 400 V ~	18.5	25	-	34		21.9	21.8	21.8	21.7	21.6	21.3	20.5	19.5	18.5	17.2	15.6	14	12			150	125	290
NKM-G 150-200/218/A/BAQV/11/4	1D8317BBX	3 x 400 V ~	11	15	-	20,5		13.2	13.1	13	13	12.8	12.5	12.1	11.5	11	10.4	9.7	9	8	7			150	125

\* To be coupled with prefilters and fixing kit

# CAST IRON PREFILTERS

FOR MONOBLOC NORMALISED CENTRIFUGAL ELECTROPUMPS



IE3 ≥ 0,75 kW

## NKP-G - 2 POLES - BASIC VERSION

Cast Iron Impeller and mechanical seal with O-Rings in Viton

MODEL *	CODE	ELECTRICAL DATA				HYDRAULIC DATA														DNA	DNM	KG								
		VOLTAGE 50 Hz		P2 NOMIN.		In (A)		Q=m³h	0	6	12	18	24	30	36	42	48	54	60				66	72						
		kW	HP	230V	400V	Q=l/min	0	100	200	300	400	500	600	700	800	900	1000	1100	1200											
NKP-G 40-125/107/A/BAQV/1,5/2	1D2117B5U	3 x 230 - 400 V ~	1,5	2	5,80	3,35	H (m)	14.7	14.5	14.3	13.8	13	11.8	10.5	8.6	7											65	40	49	
NKP-G 40-125/120/A/BAQV/2,2/2	1D2117B6U	3 x 230 - 400 V ~	2,2	3	8,23	4,75		19	18.7	18.4	17.8	17	15.9	14.6	13	11												65	40	60
NKP-G 40-125/130/A/BAQV/3/2	1D2117B7V	3 x 400 V ~	3,0	4		5,95		22.8	22.5	22.3	22	21.2	20.2	19	17.4	15.5	13.5											65	40	67

MODEL *	CODE	ELECTRICAL DATA				HYDRAULIC DATA														DNA	DNM	KG							
		VOLTAGE 50 Hz		P2 NOMIN.		In (A)		Q=m³h	0	24	30	36	42	48	54	60	66	72	78				84	90	102				
		kW	HP	230V	400V	Q=l/min	0	400	500	600	700	800	900	1000	1100	1200	1300	1400	1500				1700						
NKP-G 50-125/115/A/BAQV/3/2	1D3117B7V	3 x 400 V ~	3,0	4	-	5,95	H (m)	17	16.5	16	15.5	15	14.5	13.7	13	12	11	10	9								65	50	69
NKP-G 50-125/125/A/BAQV/4/2	1D3117B8V	3 x 400 V ~	4,0	5.5	-	8,05		20.5	20	19.5	19.1	18.5	18	17.5	16.5	15.8	14.8	14	12.5	11.5							65	50	89
NKP-G 50-125/135/A/BAQV/5,5/2	1D3117B9V	3 x 400 V ~	5,5	7.5	-	10,4		24	23.6	23.5	23.2	22.8	22.2	21.5	21	20	19.1	18.5	17.5	16.5	13.4						65	50	84

MODEL *	CODE	ELECTRICAL DATA				HYDRAULIC DATA														DNA	DNM	KG							
		VOLTAGE 50 Hz		P2 NOMIN.		In (A)		Q=m³h	0	36	42	48	54	60	66	72	78	84	90				102	114	120	150			
		kW	HP	230V	400V	Q=l/min	0	600	700	800	900	1000	1100	1200	1300	1400	1500	1700	1900				2000	2500					
NKP-G 65-125/120-110/A/BAQV/4/2	1D4117B8V	3 x 400 V ~	4,0	5.5	-	8,05	H (m)	16	15	14.6	14.2	13.7	13.3	12.8	12.3	12	11.4	10	8.5	8							80	65	80
NKP-G 65-125/127/A/BAQV/5,5/2	1D4117B9V	3 x 400 V ~	5,5	7.5	-	10,4		19.5	19	18.9	18.7	18.4	18.1	17.5	17.2	16.9	16.5	15.8	14.5	13	12						80	65	82
NKP-G 65-125/137/A/BAQV/7,5/2	1D4117BAV	3 x 400 V ~	7,5	10	-	13,4		23.5	23.1	23	22.8	22.6	22.5	22	21.6	21.1	20.7	20.2	19	17.5	14.8	12					80	65	94

MODEL *	CODE	ELECTRICAL DATA				HYDRAULIC DATA										DNA	DNM	KG									
		VOLTAGE 50 Hz		P2 NOMIN.		In (A)		Q=m³h	0	90	102	114	120	150	180				210								
		kW	HP	230V	400V	Q=l/min	0	1500	1700	1900	2000	2500	3000	3500													
NKP-G 80-160/147-127/A/BAQV/11/2	1D5217BBV	3 x 400 V ~	11,0	15	-	19,4	H (m)	24		22	21.4	20.4	20	17.4	16.8	12									100	80	179

\* To be coupled with prefilters and fixing kit

# CAST IRON PREFILTERS

FOR MONOBLOC NORMALISED CENTRIFUGAL ELECTROPUMPS



IE3 ≥ 0,75 kW

## DIAGRAM FOR SELECTING PUMP/FILTER/FIXING KIT - BASIC VERSION

Cast Iron Impeller and mechanical seal with O-Rings in Viton

POLES		TYPE OF PUMP		PREFILTER			FILTER-PUMP FIXING KIT		
2	4	MODEL	CODE		MODEL	CODE		MODEL	CODE
		• NKM-G 40-200/200/A/BAQV/1,1/4	1D2317B4W		PREFILTER 65/65	60164699		PREFILTER FIXING KIT DN 65	60166309
		• NKM-G 40-200/219/A/BAQV/1,5/4	1D2317B5W						
		• NKM-G 40-250/245/A/BAQV/2,2/4	1D2417B6W						
		• NKM-G 50-160/177/A/BAQV/1,5/4	1D3217B5W						
		• NKM-G 50-200/210/A/BAQV/2,2/4	1D3317B6W						
		• NKM-G 50-200/219/A/BAQV/3/4	1D3317B7X						
		• NKM-G 50-250/263/A/BAQV/4/4	1D3417B8X						
		• NKP-G 40-125/107/A/BAQV/1,5/2	1D2117B5U						
		• NKP-G 40-125/120/A/BAQV/2,2/2	1D2117B6U						
		• NKP-G 40-125/130/A/BAQV/3/2	1D2117B7V						
		• NKP-G 50-125/115/A/BAQV/3/2	1D3117B7V						
		• NKP-G 50-125/125/A/BAQV/4/2	1D3117B8V						
		• NKP-G 50-125/135/A/BAQV/5,5/2	1D3117B9V						
		• NKM-G 65-200/210/A/BAQV/3/4	1D4317B7X						
		• NKM-G 65-200/219/A/BAQV/4/4	1D4317B8X						
		• NKM-G 65-250/263/A/BAQV/5,5/4	1D4417B9X						
		• NKP-G 65-125/120-110/A/BAQV/4/2	1D4117B8V						
		• NKP-G 65-125/127/A/BAQV/5,5/2	1D4117B9V						
		• NKP-G 65-125/137/A/BAQV/7,5/2	1D4117BAV						
		• NKM-G 80-200/200/A/BAQV/4/4	1D5317B8X		PREFILTER FIXING KIT DN 80-100-125	60166312			
		• NKM-G 80-200/222/A/BAQV/5,5/4	1D5317B9X						
		• NKM-G 80-250/240/A/BAQV/7,5/4	1D5417BAX						
		• NKM-G 80-250/270/A/BAQV/11/4	1D5417BBX						
		• NKP-G 80-160/147-127/A/BAQV/11/2	1D5217BBV						
		• NKM-G 100-200/200/A/BAQV/5,5/4	1D6317B9X						
		• NKM-G 100-200/214/A/BAQV/7,5/4	1D6317BAX						
		• NKM-G 100-250/250/A/BAQV/11/4	1D6417BBX						
		• NKM-G 125-250/243/A/BAQV/15/4	1D7417BCX						
		• NKM-G 125-250/256/A/BAQV/18,5/4	1D7417BDX						
		• NKM-G 150-200/218/A/BAQV/11/4	1D8317BBX		PREFILTER FIXING KIT DN150-200	60166313			
			PREFILTER 200/200				60164704		

# CAST IRON PREFILTERS

FOR MONOBLOC NORMALISED CENTRIFUGAL ELECTROPUMPS



**IE3 ≥ 0,75 kW**

## NKM-G - 4 POLES - TOP VERSION

Bronze Impeller, mechanical seal with O-Rings in Viton and Pump body with cataphoresis treatment

MODEL *	CODE	ELECTRICAL DATA					HYDRAULIC DATA																DNA	DNM	KG				
		VOLTAGE 50 Hz		P2 NOMIN.		In (A)	Q=m³h	0	6	12	18	24	30	36	42	48	54	60	66	72	78								
		kW	HP	230V	400V	Q=l/min	0	100	200	300	400	500	600	700	800	900	1000	1100	1200	1300									
NKM-G 40-200/200/B/BAQV/ 1,1 /4	60180148	3 x 230 - 400 V ~	1.1	1.5	4,68	2,7	H (m)	12.5	12.5	12.3	11.2	9.7	7.7													65	40	54	
NKM-G 40-200/219/B/BAQV/ 1,5 /4	60180149	3 x 230 - 400 V ~	1.5	2	6,24	3,6		15.6	15.6	15.3	14.7	13.4	11.8	9.8													65	40	54
NKM-G 40-250/245/B/BAQV/ 2,2 /4	60180150	3 x 230 - 400 V ~	2.2	3	8,75	5,05		20.6	20.5	20.1	19.2	17.8	16														65	40	75
NKM-G 50-160/177/B/BAQV/ 1,5 /4	60180151	3 x 230 - 400 V ~	1.5	2	6,24	3,6		10.7	10.7	10.7	10.5	10.2	9.8	9.2	8.3												65	50	46
NKM-G 50-200/210/B/BAQV/ 2,2 /4	60180152	3 x 230 - 400 V ~	2.2	3	8,75	5,05		15.3	15.3	15.2	14.8	14	13.3	12.1	10.8	9.4											65	50	69
NKM-G 50-200/219/B/BAQV/ 3/4	60180153	3 x 400 V ~	3	4	-	6,25		16.8	16.8	16.5	16.1	15.5	14.6	13.6	12.4	10.9											65	50	65
NKM-G 50-250/263/B/BAQV/ 4/4	60180154	3 x 400 V ~	4	5.5	-	7,95		23.8	23.8	23.8	23.4	22.7	21.6	20.4	19	17.1											65	50	79
NKM-G 65-200/210/B/BAQV/ 3/4	60180155	3 x 400 V ~	3	4	-	6,25		15.3			15.2	15.2	15.1	14.6	14.1	13.5	12.9	12.2	11.3							80	65	72	
NKM-G 65-200/219/B/BAQV/ 4/4	60180156	3 x 400 V ~	4	5.5	-	7,95		17			17	16.9	16.8	16.4	16.2	15.8	15.2	14.3	13.8	12.6							80	65	77
NKM-G 65-250/263/B/BAQV/ 5,5 /4	60180157	3 x 400 V ~	5.5	7.5	-	10,6		24.1			23.8	23.6	23.3	22.8	22.3	21.5	20.8	19.7	18.6	17.3							80	65	165

MODEL *	CODE	ELECTRICAL DATA					HYDRAULIC DATA																DNA	DNM	KG
		VOLTAGE 50 Hz		P2 NOMIN.		In (A)	Q=m³h	0	42	48	54	60	66	72	78	84	90	102	114	120					
		kW	HP	230V	400V	Q=l/min	0	700	800	900	1000	1100	1200	1300	1400	1500	1700	1900	2000						
NKM-G 80-200/200/B/BAQV/ 4/4	60180158	3 x 400 V ~	5.5	7.5	-	7,95	H (m)	13.2	13.1	13	12.9	12.8	12.7	12.4	12	11.7	11.3	10.4	9.3	8.7	100	80	99		
NKM-G 80-200/222/B/BAQV/ 5,5 /4	60180159	3 x 400 V ~	5.5	7.5	-	10,6		16.6	16.5	16.5	16.4	16.2	16.1	16	15.7	15.4	15	14.3	13.3	12.7	100	80	153		
NKM-G 80-250/240/B/BAQV/7,5/4	60168350	3 x 400 V ~	7.5	10	-	14,6		20.4	20.3	20.3	20.2	20.1	20	19.9	19.8	19.5	19	18	16.7	16	100	80	153		
NKM-G 80-250/270/B/BAQV/11/4	60168351	3 x 400 V ~	11	15	-	20,5		25.6	25.5	25.5	25.4	25.1	25	24.8	24.6	24.2	24	23	21.5	21	100	80	205		

MODEL *	CODE	ELECTRICAL DATA					HYDRAULIC DATA																DNA	DNM	KG
		VOLTAGE 50 Hz		P2 NOMIN.		In (A)	Q=m³h	0	60	66	72	78	84	90	102	114	120	150	180	210					
		kW	HP	230V	400V	Q=l/min	0	1000	1100	1200	1300	1400	1500	1700	1900	2000	2500	3000	3500						
NKM-G100-200/200/B/BAQV/5.5 /4	60180160	3 x 400 V ~	5.5	7.5	-	10,6	H (m)	12.7	12.6	12.6	12.5	12.5	12.4	12.3	12	11.5	11.4	10.1	8.5		125	100	166		
NKM-G100-200/214/B/BAQV/7.5 /4	60168353	3 x 400 V ~	7.5	10	-	14,6		15.6	15.4	15.4	15.3	15.2	15.1	15	14.7	14.5	14.3	13.3	11.6	9.8	125	100	149		
NKM-G100-250/250/B/BAQV/11/4	60168369	3 x 400 V ~	11	15	-	20,5		21.1	21	21	21	21	21	21	20.9	20	19.8	18	16		125	100	213		

MODEL *	CODE	ELECTRICAL DATA					HYDRAULIC DATA																DNA	DNM	KG
		VOLTAGE 50 Hz		P2 NOMIN.		In (A)	Q=m³h	0	102	114	120	150	180	210	240	270	300	330	360	390	420				
		kW	HP	230V	400V	Q=l/min	0	1700	1900	2000	2500	3000	3500	4000	4500	5000	5500	6000	6500	7000					
NKM-G125-250/243/B/BAQV/15/4	60168370	3 x 400 V ~	15	20	-	28	H (m)	19.5	19.3	19.3	19.2	19.2	18.7	17.8	16.8	15.5	14.1	12.5	10.9			150	125	274	
NKM-G125-250/256/B/BAQV/18,5/4	60168371	3 x 400 V ~	18.5	25	-	34		21.9	21.8	21.8	21.7	21.6	21.3	20.5	19.5	18.5	17.2	15.6	14	12			150	125	290
NKM-G150-200/218/B/BAQV/11/4	60168376	3 x 400 V ~	11	15	-	20,5		13.2	13.1	13	13	12.8	12.5	12.1	11.5	11	10.4	9.7	9	8	7			150	125

\* To be coupled with prefilters and fixing kit

# CAST IRON PREFILTERS

FOR MONOBLOC NORMALISED CENTRIFUGAL ELECTROPUMPS



IE3 ≥ 0,75 kW

## NKP-G - 2 POLES - TOP VERSION

Bronze Impeller, mechanical seal with O-Rings in Viton and Pump body with cataphoresis treatment

MODEL *	CODE	ELECTRICAL DATA				HYDRAULIC DATA												DNA	DNM	KG					
		VOLTAGE 50 Hz		P2 NOMIN.		In (A)		Q=m³h	0	6	12	18	24	30	36	42	48				54	60	66	72	
		kW	HP	230V	400V	Q=l/min	0	100	200	300	400	500	600	700	800	900	1000				1100	1200			
NKP-G 40-125/107/B/BAQV/1,5/2	60180161	3 x 230 - 400 V ~	1,5	2	5,80	3,35	H (m)	14,7	14,5	14,3	13,8	13	11,8	10,5	8,6	7							65	40	49
NKP-G 40-125/120/B/BAQV/2,2/2	60180162	3 x 230 - 400 V ~	2,2	3	8,23	4,75		19	18,7	18,4	17,8	17	15,9	14,6	13	11							65	40	60
NKP-G 40-125/130/B/BAQV/3/2	60180163	3 x 400 V ~	3,0	4		5,95		22,8	22,5	22,3	22	21,2	20,2	19	17,4	15,5	13,5						65	40	67

MODEL *	CODE	ELECTRICAL DATA				HYDRAULIC DATA												DNA	DNM	iKG					
		VOLTAGE 50 Hz		P2 NOMIN.		In (A)		Q=m³h	0	24	30	36	42	48	54	60	66				72	78	84	90	102
		kW	HP	230V	400V	Q=l/min	0	400	500	600	700	800	900	1000	1100	1200	1300				1400	1500	1700		
NKP-G 50-125/115/B/BAQV/3/2	60180164	3 x 400 V ~	3,0	4	-	5,95	H (m)	17	16,5	16	15,5	15	14,5	13,7	13	12	11	10	9				65	50	69
NKP-G 50-125/125/B/BAQV/4/2	60180165	3 x 400 V ~	4,0	5,5	-	8,05		20,5	20	19,5	19,1	18,5	18	17,5	16,5	15,8	14,8	14	12,5	11,5			65	50	89
NKP-G 50-125/135/B/BAQV/5,5/2	60180166	3 x 400 V ~	5,5	7,5	-	10,4		24	23,6	23,5	23,2	22,8	22,2	21,5	21	20	19,1	18,5	17,5	16,5	13,4		65	50	84

MODEL *	CODE	ELECTRICAL DATA				HYDRAULIC DATA												DNA	DNM	KG						
		VOLTAGE 50 Hz		P2 NOMIN.		In (A)		Q=m³h	0	36	42	48	54	60	66	72	78				84	90	102	114	120	150
		kW	HP	230V	400V	Q=l/min	0	600	700	800	900	1000	1100	1200	1300	1400	1500				1700	1900	2000	2500		
NKP-G 65-125/120-110/B/BAQV/4/2	60180167	3 x 400 V ~	4,0	5,5	-	8,05	H (m)	16	15	14,6	14,2	13,7	13,3	12,8	12,3	12	11,4	10	8,5	8			80	65	80	
NKP-G 65-125/127/B/BAQV/5,5/2	60180168	3 x 400 V ~	5,5	7,5	-	10,4		19,5	19	18,9	18,7	18,4	18,1	17,5	17,2	16,9	16,5	15,8	14,5	13	12		80	65	82	
NKP-G 65-125/137/B/BAQV/7,5/2	60168378	3 x 400 V ~	7,5	10	-	13,4		23,5	23,1	23	22,8	22,6	22,5	22	21,6	21,1	20,7	20,2	19	17,5	14,8	12	80	65	94	

MODEL *	CODE	ELECTRICAL DATA				HYDRAULIC DATA												DNA	DNM	KG
		VOLTAGE 50 Hz		P2 NOMIN.		In (A)		Q=m³h	0	90	102	114	120	150	180	210				
		kW	HP	230V	400V	Q=l/min	0	1500	1700	1900	2000	2500	3000	3500						
NKP-G 80-160/147-127/B/BAQV/11/2	60168379	3 x 400 V ~	11,0	15	-	19,4	H (m)	24		22	21,4	20,4	20	17,4	16,8	12	100	80	179	

\* To be coupled with prefilters and fixing kit

# CAST IRON PREFILTERS

FOR MONOBLOC NORMALISED CENTRIFUGAL ELECTROPUMPS



IE3 ≥ 0,75 kW

## DIAGRAM FOR SELECTING PUMP/FILTER/FIXING KIT - TOP VERSION

Bronze Impeller, mechanical seal with O-Rings in Viton and Pump body with cataphoresis treatment

POLES		TIPO POMPA		PREFILTER		FILTER-PUMP FIXING KIT			
2	4	MODEL	CODE	MODEL	CODE	MODEL	CODE		
		• NKM-G 40-200/200/B/BAQV/1,1/4	60180148				<b>PREFILTER FIXING KIT DN 65</b> 60166309		
		• NKM-G 40-200/219/B/BAQV/1,5/4	60180149						
		• NKM-G 40-250/245/B/BAQV/2,2/4	60180150						
		• NKM-G 50-160/177/B/BAQV/1,5/4	60180151						
		• NKM-G 50-200/210/B/BAQV/2,2/4	60180152						
		• NKM-G 50-200/219/B/BAQV/3/4	60180153						
		• NKM-G 50-250/263/B/BAQV/4/4	60180154						
		• NKP-G 40-125/107/B/BAQV/1,5/2	60180161						
		• NKP-G 40-125/120/B/BAQV/2,2/2	60180162						
		• NKP-G 40-125/130/B/BAQV/3/2	60180163						
		• NKP-G 50-125/115/B/BAQV/3/2	60180164						
		• NKP-G 50-125/125/B/BAQV/4/2	60180165						
		• NKP-G 50-125/135/B/BAQV/5,5/2	60180166						
		• NKM-G 65-200/210/B/BAQV/3/4	60180155						
		• NKM-G 65-200/219/B/BAQV/4/4	60180156						
		• NKM-G 65-250/263/B/BAQV/5,5/4	60180157						
		• NKP-G 65-125/120-110/B/BAQV/4/2	60180167						<b>PREFILTER FIXING KIT DN 80-100-125</b> 60166312
		• NKP-G 65-125/127/B/BAQV/5,5/2	60180168						
		• NKP-G 65-125/137/B/BAQV/7,5/2	60168378						
		• NKM-G 80-200/200/B/BAQV/4/4	60180158						
		• NKM-G 80-200/222/B/BAQV/5,5/4	60180159						
		• NKM-G 80-250/240/B/BAQV/7,5/4	60168350						
		• NKM-G 80-250/270/B/BAQV/11/4	60168351						
		• NKP-G 80-160/147-127/B/BAQV/11/2	60168379						
		• NKM-G 100-200/200/B/BAQV/5,5/4	60180160						
		• NKM-G 100-200/214/B/BAQV/7,5/4	60168353						
		• NKM-G 100-250/250/B/BAQV/11/4	60168369						
		• NKM-G 125-250/243/B/BAQV/15/4	60168370		<b>PREFILTER FIXING KIT DN150-200</b> 60166313				
		• NKM-G 125-250/256/B/BAQV/18,5/4	60168371						
		• NKM-G 150-200/218/B/BAQV/11/4	60168376						

# EUROCOVER

SUBMERSIBLE SWIMMING POOL PUMPS



Totally automatic submersible electric pump, with wide support base specially designed to increase stability and to offer the possibility to operate also in positions which are not perfectly perpendicular to the ground.

Suitable for use during the winter period above the pool covers, to remove rainwater and avoid damage to the cover due to the excessive weight of the accumulated water. Electric pump made of resistant thermoplastic material. Motor, shaft, bolts and screws in stainless steel.

Triple interposed ring seal with oil prechamber.

Incorporated float for automatic operation.

Submersible with continuous duty asynchronous motor.

Stator positioned in stainless steel enclosure with cap to cover wiring and capacitor.

**Protection rating** IP68

**Insulation class** F

**Input voltage** 230V - 50Hz single phase

Supplied with 10m cable and Schuko plug / 10 m rope for positioning on sheets

Multi-hose fitting with clapet valve

**Operating range**

From 0.5 to 6 m<sup>3</sup>/h with head up to 6.5 m

**Liquid temperature range**

From 0 to 35 °C (EN 60335-2-41)

**Installation** fixed or portable in vertical position (max. inclination 10°)

**Particle size** 5 mm

**Automatic start/stop** start 55 mm - stop 35 mm

MODEL	CODE	ELECTRICAL DATA					HYDRAULIC DATA						WEIGHT KG	Q.TY x PALLET
		VOLTAGE 50 Hz	P1 MAX kW	P2 NOMINAL		Q=m <sup>3</sup> /h	0	1,2	2,4	3,6	4,8	6		
				kW	HP									
EUROCOVER	60115704	230V~	0,25	0,22	0,3	H (m)	6,5	5,1	4	3	1,9	0,5	4,6	36

B9 B8

# JETCOM SP - EUROCOM SP

SWIMMING POOL CENTRIFUGAL PUMPS



Self-priming centrifugal (Jetcom) or multistage (Eurocom) pump with excellent suction capacity even when there are air bubbles. Suitable for use with water containing small sand impurities. Especially suitable for water supplies in domestic systems: handling of aggressive water in general with chlorine contents (swimming pools). Pump body in technopolymer.

**Support and seal-carrier in AISI 316 STAINLESS STEEL.**

Carbon/ceramic mechanical seal.

**Rotor shaft in AISI 316 STAINLESS STEEL.**

Impellers, diffuser, Venturi tube, and sand guard in technopolymer. Clearance rings in stainless steel.

Continuous duty asynchronous motor.

Built-in motor overload cut out and a capacitor

permanently on in the single-phase version.

Protection for the three-phase version is the responsibility of the user.

**Motor protection level** IP 44

**Terminals protection level** IP 55

**Insulation class** F

**Standard voltage** 220/240V - 50 Hz single-phase 230/400V - 50 Hz three-phase

**Operating range** from 10 to 80 l/min with head of up to 58 m depending on the model

**Liquid quality requirements** clean, free of solid or abrasive contaminants, swimming pool water (containing chlorine).

**Liquid temperature range**

from 0°C to +35°C for domestic use

(EN 60335-2-41)

from 0°C to +40°C for other uses.

**Maximum ambient temperature** +40°C

**Maximum operating pressure** 6 bar (600 kPa)

**Installation** fixed or portable in horizontal position

IE3 ≥ 0,75 kW

IE2 ≥ 0,75 kW

EXTRA EU

MODEL	CODE	ELECTRICAL DATA						HYDRAULIC DATA												DNA GAS	DNM GAS	WT. KG	Q.TY x PALLET
		VOLTAGE 50 Hz	P1 MAX KW	P2 NOMINAL		In A	MOTOR TYPE	Q=m <sup>3</sup> /h	0	0,6	1,2	1,8	2,4	3,0	3,6	4,2	4,8						
				kW	HP			Q=l/min	0	10	20	30	40	50	60	70	80						
JETCOM 82 SP M	60115706	1x220-240 V~	0,85	0,6	0,8	3,8	-	H (m)	47	40	34	30	26,2	23,5	20			1"	1"	7,7	28		
JETCOM 102 SP M	102676030	1x220-240 V~	1,13	0,75	1	5,1	-		53,8	47	41	36,3	32,4	28,8	25,8			1"	1"	9,5	28		
JETCOM 102 SP T	60181157	3x230-400 V~	1,04	0,75	1	3,42	IE3		53,8	47	41	36,3	32,4	28,8	25,8			1"	1"	9,5	28		
EUROCOM SP 30/50 M	102966260	1x220-240 V~	0,88	0,55	0,75	3,9	-		42,2	40,2	38,2	36,2	33,8	30	24,8	19,5	14	1"	1"	8,8	28		
EUROCOM SP 30/50 T	102966270	3x230-400 V~	0,87	0,55	0,75	2,8-1,6	-		42,2	40,2	38,2	36,2	33,8	30	24,8	19,5	14	1"	1"	8,8	28		
EUROCOM SP 40/50 M	102966280	1x220-240 V~	1,2	0,75	1	5,3	-		57,7	55,3	52,8	50,1	47,1	42,7	35,8	28	19,2	1"	1"	11	28		
EUROCOM SP 40/50 T	60179420	3x230-400 V~	1,07	0,75	1	3,6-2,1	IE3		57,7	55,3	52,8	50,1	47,1	42,7	35,8	28	19,2	1"	1"	11,3	28		
EUROCOM SP 40/50 T	60145281	3x230-400 V~	1180	0,75	1	3,8-2,2	IE2		H (m)	57,7	55,3	52,8	50,1	47,1	42,7	39,5	35,8	28	19,2	1"	1"	11,3	28



# MULTI 4 SW

SELF-PRIMING HORIZONTAL MULTISTAGE PUMPS



Is a self-priming multistage surface pump specifically constructed to pump salt water. Low noise and high pressure performance. **Available with 4-Noryl impeller.**

Anti-corrosive and rust-proof materials.

Motor with thermic overload protection.

Double sealing system between motor and hydraulic part. High resistance to frost and icing.

Supplied with power cable with plug, and self-sealing fitting.

Supplied complete with power cable and plug.

### Operating range

capacity up to 90 l/min; head up to 46 m.

### Liquid temperature range

from 0 °C to +35 °C for domestic use.

from 0 °C to +40 °C for other uses.

### Pumped liquid

Designed to specifically pump salt water.

**Maximum suction capacity** 8 metres.

**Maximum ambient temperature** +40 °C.

**Protection class** IPX4.

**Insulation class** F.

**Installation** fixed or portable, horizontal position.

Special versions on requests: alternative voltages and/or frequencies.

MODEL	CODE	ELECTRICAL DATA					HYDRAULIC DATA													N° IMPELLERS	DNA GAS	DNM GAS	WT. KG	Q.TY x PALLET
		VOLTAGE 50 Hz	P1 MAX KW	P2 NOMINAL		In A	Q=m³h	0	0,6	1,2	1,8	2,4	3,0	3,6	4,2	4,8	5,4							
				Q=l/min	0		10	20	30	40	50	60	70	80	90									
<b>MULTI 4 SW M</b>	60122695	1x220-240 V~	1	0,75	1	4,5	H (m)	46	45	43	40	38	33	28	22	16	9	4	1"	1"	10,6	21		

A7

# NOVA SALT W

SUBMERSIBLE PUMPS



The Nova Salt WM-A is a multi-purpose submersible pump specifically constructed for use in **salt water**.

Anti-corrosive and rust-proof materials.

Motor casing, shaft, screws and nuts made of stainless steel AISI 316.

Cable with tin plated conductors.

Motor with thermic overload protection.

Wear resistant shaft and impeller.

Excellent cooling of the motor that enables the pump to operate even when it is partially submersible.

Manual and Automatic version with start/ stop float switch.

Supplied with power cable with plug and self-sealing fitting.

### Operating range

from 1 to 7.5 m³/h with head up to 6 metres.

### Liquid temperature range

from 0 °C to +35 °C for domestic use.

**Pumped liquid** dirty water, without fibre, including salt water.

**Max. immersion depth** 7 metres.

MODEL	CODE	ELECTRICAL DATA					HYDRAULIC DATA													DNM GAS	CABLE	WEIGHT KG	Q.TY x PALLET
		VOLTAGE 50 Hz	P1 MAX KW	P2 NOMINAL		In A	Q=m³h	0	1	2	3	4,5	5	6	7	7,5							
				Q=l/min	0		16,6	33,3	50	75	83,3	100	116,6	125									
<b>NOVA SALT W M-A</b>	60122652	1x230 V~	0,28	0,2	0,28	1,3	H (m)	6	5,4	4,7	3,9	2,8	2,5	1,7	1	0,5	1"¼	10 mt.	3,9	48			

# NOVAPOND

## SUBMERSIBLE PUMPS



The models NovaPond are submersible pumps specially designed for the recirculation of water in garden ponds, to create waterfalls or other water features. They are designed to pump clean water containing solid particles with a maximum diameter of 10 mm.

Suitable for continuous operation.

Designed for horizontal or vertical installation.

Environmentally safe.

Materials resistant to corrosion and oxidation.

Motor with thermal overload protection.

Adjustable suction filter to enable transit of solid particles with a diameter from 5 mm to 10 mm.

Supplied with power cable and plug, and self-sealing coupling.

### Operating range

from 1 to 14 m<sup>3</sup>/h with head up to 9.4 metres. Suitable for continuous operation.

### Liquid temperature range

from 0 °C to +35 °C.

### Pumped liquid

clean water, without fibres and with particles with maximum diam. 10 mm.

**Max. immersion depth** 7 metres.

### ACCESSORIES PAG. 129

MODEL	CODE	ELECTRICAL DATA				HYDRAULIC DATA														DNM GAS	CABLE	WEIGHT KG	Q.TY x PALLET
		VOLTAGE 50 Hz	P1 MAX W	P2 NOMINAL		In A	Q=m <sup>3</sup> h	0	1	2	3	4,5	6	7,5	9	10,5	12	14					
				KW	HP		Q=l/min	0	17	33	50	75	100	125	150	175	200	233					
NOVAPOND 200 M	60122681	1X230 V~	280	0,2	0,28	1,3	H (m)	6,98	6,35	5,55	4,75	3,6	2,2	0,65					1"¼	10 mt.	4,3	48	
NOVAPOND 550 M	60122684	1X230 V~	750	0,55	0,75	3,3		9,4	9,15	8,95	8,58	7,86	6,9	5,9	4,8	3,53	2,1	0,44	1"¼	10 mt.	6,2	48	

# ACCESSORIES FOR SWIMMING POOL , POND AND SALT WATER PUMPS

---





# ACCESSORIES

FOR SWIMMING POOL, POND AND SALT WATER PUMPS

KIT CONNECTION CABLE	DESCRIPTION	CODE
	ESWIM CONNECTION CABLE 16 M KIT 12 PIN	60194430
	KIT CONNECTION CABLE ESWIM + KIT DIGITAL INPUT (E.ADAPT)	60192661

UNIONS KIT	DESCRIPTION	CODE
	2" UNIONS KIT / DN 50-63 FOR EUROSWM, ESWIM AND EPRO	60120005

COUNTER FLANGE KIT	DESCRIPTION	CODE
	COUNTER FLANGE KIT SUCTION + DELIVERY FOR EUROPRO HIGH FLOW	60165456

WATER FEATURES FOR NOVAPOND	DESCRIPTION	CODE
	TELESCOPIC TUBE	LP050001
	3 LEVELS	LP050003
	FOAM	LP050004
	FLOWER	LP050005
	MUSHROOM HEAD HOUSING	LP050006



CENTRIFUGAL



DOWNLOAD  
TECHNICAL CATALOGUE



CENTRIFUGAL  
ELECTRONIC



## KPA

SELF-PRIMING PERIPHERAL PUMPS

AB

PAG. 132



## KPS-KPF

PERIPHERAL PUMPS

AB

PAG. 132



## KP

PERIPHERAL PUMPS

AB

PAG. 133



## KE SINGLE IMPELLER

SINGLE IMPELLER CENTRIFUGAL PUMPS

BO

PAG. 134

WITH  
MCE/P



## KE TWIN IMPELLER

TWIN IMPELLERS CENTRIFUGAL PUMPS

BP

PAG. 135

WITH  
MCE/P



## NKM-GE / NKP-GE

ENBLOC CENTRIFUGAL PUMPS WITH INVERTER  
FOR PRESSURIZATION SYSTEM

BG

PAG. 137

WITH  
MCE/P



## KDNE

STANDARDISED CENTRIFUGAL PUMPS  
WITH INVERTER FOR PRESSURIZATION SYSTEM

BC

PAG. 141

WITH  
MCE/P



## KVCE 30-50-80-120

MULTISTAGE CENTRIFUGAL PUMPS WITH  
VERTICAL AXIS

BL

PAG. 143

WITH  
MCE/P



## NKVE 1-3-6-10-15-20 S

MULTISTAGE CENTRIFUGAL  
PUMPS WITH VERTICAL AXIS

FG

FH

PAG. 144

WITH  
MCE/P



## NKVE 32-45-65-95

MULTISTAGE CENTRIFUGAL  
PUMPS WITH VERTICAL AXIS

FI

PAG. 148

WITH  
MCE/P



## NKM-GE / NKP-GE

ENBLOC CENTRIFUGAL PUMPS WITH INVERTER  
FOR CIRCULATING SYSTEM

BG

PAG. 152

WITH  
MCE/C



## KDNE

STANDARDISED CENTRIFUGAL PUMPS  
WITH INVERTER FOR CIRCULATING SYSTEM

BC

PAG. 157

WITH  
MCE/C



## KI

AISI 304 STAINLESS STEEL SINGLE  
IMPELLER CENTRIFUGAL PUMPS

EP

PAG. 160



## K SINGLE IMPELLER

SINGLE IMPELLER CENTRIFUGAL PUMPS

BO

PAG. 161



## K TWIN IMPELLER

TWIN IMPELLERS CENTRIFUGAL PUMPS

BP

PAG. 163



## KC / KCV

CENTRIFUGAL PUMPS FOR  
AIR CONDITIONING

BX

PAG. 165



## NKM-G - NKP-G

STANDARDISED ENBLOC CENTRIFUGAL PUMPS

BE

PAG. 166



## KDN

STANDARDISED CENTRIFUGAL PUMPS

BC

PAG. 182



## KDN OVERSIZE

STANDARDISED CENTRIFUGAL PUMPS

BF

PAG. 191



## KVC - KVCX

MULTISTAGE CENTRIFUGAL PUMPS  
WITH VERTICAL AXIS

BL

BM

PAG. 193



## NKV 1-3-6-10-15-20 S

MULTISTAGE CENTRIFUGAL PUMPS  
WITH VERTICAL AXIS

FG

FH

PAG. 197



## NKV 32-45-65-95

MULTISTAGE CENTRIFUGAL PUMPS  
WITH VERTICAL AXIS

FI

PAG. 203



## ACCESSORIES

PAG. 207

# KPA

## SELF-PRIMING PERIPHERAL PUMPS



Self-priming peripheral pump with star impeller, with a great suction capacity. Cast iron body with brass ring. Motor support and impeller in brass to avoid the risk of blocking. Driving shaft in stainless steel. Carbon/ceramic mechanical seal. Asynchronous, closed motor, cooled by external ventilation. Built-in thermal and current overload protection and a capacitor permanently on in the single-phase version. For the protection of the three-phase motor it is advisable to use a suitable overload protection complying with the regulations in force.

- Operating range** from 8 to 45 l/min. with head up to 53 metres.
- Liquid temperature range** from -10°C to +80°C from 0°C to +35°C for domestic use.
- Pumped liquid characteristics** clean, free from solids or abrasive substances, not viscous, not aggressive, not crystallised and chemically neutral.
- Maximum ambient temperature** +40°C
- Maximum working pressure** 10 bar (1000 kPa).
- Protection level** IP 44 (IP 55 terminal board protection).
- Insulation class** F

IE3 ≥ 0,75 kW

IE2 ≥ 0,75 kW EXTRA EU

MODEL	CODE	ELECTRICAL DATA						HYDRAULIC DATA								DNA	DNM	Weight Kg	Q.TY x PALLET		
		VOLTAGE 50 Hz	P1 MAX kW	P2 NOMINAL kW HP		In A	MOTOR TYPE	Q=m³h	0	0,3	0,6	0,9	1,2	1,8	2,4					Q=l/min	0
KPA 40/20 M	101120000	1 x 230 V ~	1,1	0,75	1	5,1	-	H (m)	53	51	48	43	38	27	16	1°G	1°G	12,40	39		
KPA 40/20 T	60180169	3 x 230 - 400 V ~	1,3	0,75	1	4-2,3	IE3		53	51	48	43	38	27	16	1°G	1°G	12,40	39		
KPA 40/20 T	60145185	3 x 230 - 400 V ~	1	0,75	1	3,5-2,1	IE2	H (m)	53	51	48	43	38	27	16	1°G	1°G	12,40	39		

# KPS - KPF - KP

## PERIPHERAL PUMPS



Peripheral centrifugal pump, reduced encumbrance, able to generate high heads, it is suitable for domestic use and small industrial uses. Pump body and motor support in brass for the KP 60 version, in cast iron for the KPS 30 and KP 38 versions. Brass impeller. Mechanical seal in carbon/ceramic. Asynchronous, closed motor, cooled by external ventilation. Built-in thermal and current overload protection and a capacitor permanently on in the single-phase version. For the protection of the three-phase motor it is advisable to use a suitable overload protection complying with the regulations in force.

- Operating range** from 1 to 50 l/min. with head up to 107 metres.
- Liquid temperature range** from 0°C to +35°C for domestic use. from -10°C to +50°C for other uses.
- Pumped liquid characteristics** clean, free from solids or abrasive substances, not viscous, not aggressive, not crystallised and chemically neutral.
- Maximum ambient temperature** +40°C
- Maximum working pressure** 10 bar (6 bar for KPS-KPF 30/16).
- Protection level** IP 44
- Insulation class** F

IE3 ≥ 0,75 kW

IE2 ≥ 0,75 kW EXTRA EU

MODEL	CODE	ELECTRICAL DATA						HYDRAULIC DATA								DNA	DNM	WEIGHT Kg	Q.TY x PALLET		
		VOLTAGE 50 Hz	P1 MAX kW	P2 NOMINAL kW HP		In A	MOTOR TYPE	Q=m³h	0	0,3	0,6	0,9	1,2	1,8	2,4					Q=l/min	0
KPF 30/16 M	101110400	1 x 230 V ~	0,53	0,37	0,5	2,37	-	H (m)	32,5	31	25	22	17,5	10		1°G	1°G	5,3	110		
KPF 30/16 T	101110410	3 x 230 - 400 V ~	0,47	0,37	0,5	1,45-0,82	-		32,5	31	25	22	17,5	10		1°G	1°G	5,3	110		
KPS 30/16 M	101110024	1 x 230 V ~	0,47	0,37	0,5	2	-		32,5	31	25	22	17,5	10		1°G	1°G	5,4	120		
KPS 30/16 T	101110014	3 x 230 - 400 V ~	0,45	0,37	0,5	1,4-0,8	-		32,5	31	25	22	17,5	10		1°G	1°G	5,4	120		
KPS 30/16 M-P	101112224	1 x 230 V ~	0,47	0,37	0,5	2	-		32,5	31	25	22	17,5	10		1°G	1°G	5,4	36		
KP 38/18 M	101110060	1 x 230 V ~	0,89	0,6	0,8	4	-		54	50	46	41	36	27,5	17,5	1°G	1°G	7,5	68		
KP 38/18 T	101110050	3 x 230 - 400 V ~	0,86	0,6	0,8	2,9-1,7	-		54	50	46	41	36	27,5	17,5	1°G	1°G	7,5	68		
KPF 45/20 M	60141934	1 x 230 V ~	1,5	1,0	1,34	5,9	-		84	76	68	62	56	38	24	1°G	1°G	9,0	39		
KPF 45/20 T	60179405	3 x 230 - 400 V ~	1,2	1,0	1,34	4-2,3	IE3		84	76	68	62	56	38	24	1°G	1°G	9,0	39		
KPF 45/20 T	60145268	3 x 230 - 400 V ~	1,4	1,0	1,34	-	IE2		H (m)	84	76	68	62	56	38	24	1°G	1°G	9,0	39	

<sup>1</sup> KPS-fitted Pump fitted with a pressure gauge, pressure switch, power supply cable with plug and five-way fitting for connection to a tank.

# KP

## PERIPHERAL PUMPS



Pump body, motor support and impeller in brass. Carbon/ceramic mechanical seal. Stainless steel motor shaft. Asynchronous, closed motor cooled by external ventilation. Rotor mounted on oversized greased sealed-for-life ball bearings to ensure silent running and long life. Motor overload cut out equipped as standard in the single-phase version. Overload protection to be provided by the user for the three-phase version. Permanently connected capacitor for the single-phase version. Construction to CEI 2-3 and CEI 61-69 (EN 60335-2-41)

**Protection rating** IP 44

**Insulation class** F

**Standard voltage**

1x230V 50Hz single-phase

3x230-400V 50Hz three-phase

**Operating range**

from 1 to 35 l/min with head up to 107 meters.

**Pumped liquid** clean, free from solids or abrasive substances, not aggressive.

**Liquid temperature range**

- from 0°C to +35°C for domestic use

(EN 60335-2-41)

- from -10°C to +80°C for other uses.

**Maximum ambient temperature** +40°C

**Maximum working pressure** 10 bar (1000 kPa).

**Installation** fixed in horizontal position.

**IE3 ≥ 0,75 kW**

**IE2 ≥ 0,75 kW**

**EXTRA EU**

MODEL	CODE	ELECTRICAL DATA					HYDRAULIC DATA										DNA	DNM	WEIGHT Kg	Q.TY x PALLET	
		VOLTAGE 50 Hz	P1 MAX kW	P2 NOMINAL kW HP		In A	MOTOR TYPE	Q=m³/h	0	0,3	0,6	0,9	1,2	1,8	2,4	Q=l/min					0
KP 60/6 M	101110280	1 x 230 V ~	0,54	0,37	0,5	2,4	-	H (m)	87	57	33	13				½" G	½" G	8,2	39		
KP 60/6 T	101110290	3 x 230 - 400 V ~	0,52	0,37	0,5	1,8-1	-		87	57	33	13				½" G	½" G	7,9	39		
KP 60/12 M	101110320	1 x 230 V ~	1,15	0,75	1	5,2	-		107	91	74	58	43	17		¾" G	¾" G	10,1	39		
KP 60/12 T	60180170	3 x 230 - 400 V ~	1,1	0,75	1	3,6-2,1	IE3		107	91	74	58	43	17		¾" G	¾" G	9,90	39		
KP 60/12 T	60145184	3 x 230 - 400 V ~	1,12	0,75	1	3,8-2,2	IE2	H (m)	107	91	74	58	43	17		¾" G	¾" G	9,90	39		

# KE SINGLE IMPELLER

## SINGLE IMPELLER CENTRIFUGAL PUMPS WITH INVERTER MCE/P



Single impeller centrifugal pump suitable for pressure booster systems and domestic, civil, industrial and agricultural systems.

Particularly versatile thanks to the use of the **MCE/P** inverter, this pump guarantees the automatic adjustment of its performance to the various system requirements, while maintaining constant the differential pressure. Pressure sensor included. Pump body and motor support in cast iron. Technopolymer impeller for the KE 36/200, KE 40/200 and KE 55/200 versions; cast iron impeller for the other pumps. Carbon/ceramic mechanical seal. Asynchronous, closed motor cooled by external ventilation. Motor shaft mounted on generously sized ball bearings to ensure silent running and long life.

### Operating range

from 6 to 100 m<sup>3</sup>/h with head up to 60 meters.

### Liquid temperature range

from -10°C to +50°C for the KE 36/200 and KE 40/200 versions, from -15°C to +110°C for other pumps.

**Pumped liquid** clean, free from solids or abrasive substances, not viscous, not aggressive, not crystallised and chemically neutral, close to the properties of water.

**Installation** normally horizontal or vertical provided the motor is always above the pump.

**Maximum ambient temperature** +40°C.

### Maximum working pressure

KE 36/200, KE 40/200, KE 55/200: 8 bar (800 kPa)  
KE 40/400, KE 50/400, KE 30/800, KE 40/800, KE 50/800, KE 20/1200, KE 25/1200, KE 35/1200: 10 bar (1000 kPa)

**Protection rating** IP 44.

**Terminal box protection rating** IP 55.

**Insulation class** F.



PAG. 5

MCE/P  
PAG. 23

## KE SINGLE IMPELLER WITH MCE/P - FOR PRESSURIZATION SYSTEM

MODEL	CODE	ELECTRICAL DATA					HYDRAULIC DATA																DNA	DNM	WEIGHT Kg
		VOLTAGE 50 Hz	P1 MAX kW	P2 NOMINAL		In A	Q=m <sup>3</sup> /h																		
				kW	HP		0	1,8	2,4	3,6	4,8	6	7,2	9	9,6	10,8	12	15	18						
KE 36/200 T MCE30/P	60144849	3 x 400V	3,2	2,2	3	6,96		36,6					36	35,5	35	34	33,3	32,5	31,5	28	23,5	2° G	1¼" G	39,9	
KE 40/200 T MCE30/P	60144850	3 x 400V	3,8	3	4	8,93	H (m)	41,3				41	40,5	40	39	38,8	38	37	33,5	29		2° G	1¼" G	41,7	
KE 55/200 T MCE55/P	60144851	3 x 400V	5,3	4	5,5	10,90		54				54	53,9	53,2	53	52	51,5	48,5	45		2° G	1¼" G	41,7		

MODEL	CODE	ELECTRICAL DATA					HYDRAULIC DATA																DNA	DNM	WEIGHT Kg
		VOLTAGE 50 Hz	P1 MAX kW	P2 NOMINAL		In A	Q=m <sup>3</sup> /h																		
				kW	HP		0	12	15	18	24	30	36	42	60	72	84	96							
KE 40/400 T MCE55/P	60167376	3 x 400V	6,7	5,5	7,5	14,67	H (m)	50,5	49	48	45	37	24									65	50	86,6	
KE 50/400 T MCE110/P	60167377	3 x 400V	8,9	7,5	10	18,74		62	61	60	59	54,5	46									65	50	91,7	
KE 30/800 T MCE110/P	60167378	3 x 400V	8,5	7,5	10	18,19		44				42	40	38	35	21,5						80	65	103,1	
KE 40/800 T MCE110/P	60167379	3 x 400V	10,4	9,2	12,5	21,48		51,5				50	48	47	43,5	32,5	21					80	65	107,9	
KE 50/800 T MCE110/P	60167380	3 x 400V	13,5	11	15	27,49		58				56,5	55	53,5	51	41	31					80	65	117,2	
KE 25/1200 T MCE110/P	60167381	3 x 400V	12,0	10	12,5	20,92		40,7				39	38,5	38	37	33,5	30	25	18			80	65	106,9	
KE 35/1200 T MCE110/P	60167382	3 x 400V	11,4	12	15	25,10		45						43	42,5	38,5	35	31,5	27			80	65	112,9	



# KE TWIN IMPELLERS

TWIN IMPELLERS CENTRIFUGAL PUMPS WITH INVERTER MCE/P



Twin impeller centrifugal pump, suitable for pressure booster systems and domestic, civil, industrial and agricultural systems. Particularly versatile thanks to the use of the **MCE/P** inverter, this pump guarantees the automatic adjustment of its performance to the various system requirements, while maintaining constant the differential pressure. Pressure sensor included. Pump body and motor support in cast iron. Technopolymer impeller. Carbon/ceramic mechanical seal. Asynchronous, closed motor cooled by external ventilation. Motor shaft mounted on generously sized ball bearings to ensure silent running and long life.

### Operating range

from 2 to 30 m<sup>3</sup>/h with head up to 95 meters.

### Liquid temperature range

from -10 °C to 50 °C: for KE 35/40, KE 45/50, KE 55/100.

from -15 °C to 110 °C: for KE 55/50, K 66/100, K 90/100, K 70/300, K 80/300, K 70/400, K 80/400.

**Pumped liquid** clean, free from solids or abrasive substances, not viscous, not aggressive, not crystallised and chemically neutral, close to the properties of water. **Installation:** normally horizontal or vertical provided the motor is always above the pump.

**Maximum ambient temperature** +40°C.

### Maximum working pressure

KE 35/40: 6 bar (600 kPa)

KE 45/50, KE 55/50: 8 bar (800 kPa)

KE 55/100, KE 66/100: 10 bar (1000 kPa)

KE 90/100, KE 70/300, KE 80/300 KE 70/400,

KE 80/400: 12 bar (1200 kPa).

**Protection rating** IP 44.

**Terminal box protection rating** IP 55.

**Insulation class** F.



PAG. 5

MCE/P  
PAG. 23

## KE TWIN IMPELLERS WITH MCE/P - FOR PRESSURIZATION SYSTEM

MODEL	CODE	ELECTRICAL DATA				HYDRAULIC DATA																			DNA	DNM	Weight Kg					
		VOLTAGE 50 Hz	P1 MAX kW	P2 NOMINAL		In A	Q=m <sup>3</sup> /h Q=l/min	H (m)																								
				kW	HP			0	1,2	1,8	2,4	3,6	4,8	6	7,2	9	9,6	10,8	12	15	18	24	30									
KE 35/40 M MCE11/P	60147869	1 x 230V	1,3	0,75	1,0	10,3	43,5	41,5	40	38	33	23,5															1" G	1" G	20,5			
KE 45/50 M MCE15/P	60147870	1 x 230V	2	1,6	2,2	14,7	51	49	47,5	46	42	37	30																1¼" G	1" G	27,7	
KE 55/50 M MCE15/P	60147871	1 x 230V	2,53	1,6	2,2	18,1	62	60	58	57	52	45	34																	1½" G	1" G	28,2
KE 55/100 T MCE30/P	60144859	3 x 400V	3,66	2,2	3,0	8,93	62			59,5	57	54,5	51	47	39	36														1½" G	1" G	44,9
KE 66/100 T MCE30/P	60144860	3 x 400V	4,32	3,0	4,0	9,64	73			70	67,5	64	60,5	57	49	47														1½" G	1" G	47,5
KE 90/100 T MCE55/P	60144861	3 x 400V	5,23	3,0	4,0	10,8	83,5			82	79,5	76,5	72,5	68	61	58														1½" G	1" G	50,8
KE 70/300 T MCE55/P	60180171	3 x 400V	6,73	5,5	7,5	14,1	76						74	73	72	71,5	70	69	65	60,5	43,5									2" G	1¼" G	79,8
KE 80/300 T MCE110/P	60167383	3 x 400V	9,83	7,5	10,0	19,4	95						93	92,2	91	90,5	90	89,5	87	82	68									2" G	1¼" G	86,6
KE 70/400 T MCE110/P	60167384	3 x 400V	9,57	9,2	12,5	20,4	86								84	83,2	82,5	82	79	76	65	47								2" G	1¼" G	86,9
KE 80/400 T MCE110/P	60167385	3 x 400V	11,2	11,0	15,0	22,7	97									95	94,5	94	92	89	80	64								2" G	1¼" G	90,9



# NKM-GE / NKP-GE WITH MCE/P

ENBLOC CENTRIFUGAL PUMPS WITH INVERTER



Enbloc electric centrifugal pumps with coupling, designed for a wide range of applications such as:

- homes;
- apartment blocks;
- camp sites;
- swimming pools;
- farms;
- well water supply;
- irrigation for greenhouses, gardens, agriculture;
- re-use of rainwater;
- industrial systems.

Highly versatile pumps thanks to the use of the **MCE/P** inverter, to guarantee performance able to automatically adapt to the various system requirements, while maintaining constant pressure. Spiral single-stage body in cast iron according to DIN-EN 733 (ex DIN 24255), cast iron support, flanges according to DIN 2533 and DIN 2532 for DN 200. Cast iron impeller, sealed and dynamically balanced with compensation of the axial thrust via balancing holes, operating (on request) on interchangeable wear rings. Pump shaft in AISI 304 stainless steel. Seal: standardised mechanical seal according to DIN 24960 in carbon/silicon carbide with O-rings in EPDM. Asynchronous, closed motor cooled by external ventilation, construction design B3/B5, 2-pole for NKPGE and 4-pole for NKM-GE. Rotor mounted on generously sized ball bearings to ensure silent and durable operation.

**Speed of rotation** 1450 - 2900 1/min.

### Operating range

from 1 a 450 m<sup>3</sup>/h head up to 72 metri.

**Liquid temp. range** from -10°C to +80°C.

**Pumped liquid** clean, free from solids or abrasive substances, not viscous, not aggressive, not crystallised and chemically neutral and close to the characteristics of water. **Installation:** normally horizontal or vertical provided the motor is always above the pump.

**Max. ambient temperature** +40°C

### Maximum operating pressure

16 bar - 1600 kPa (for DN 200 max. 10 bar).

**Protection rating** IP 55

**Insulation class** F

**Flanging** PN 16 DIN 2533

### Special versions on request

Pumps for liquids other than water.

Other voltages and/or frequencies.

Inverter modulation with 0-10V signal

IE3 ≥ 0,75 kW

**D+CONNECT**

PAG. 5

MCE/P  
PAG. 23

ACCESSORIES  
PAG. 207

## NKM-GE 4 POLES WITH MCE/P - FOR PRESSURIZATION SYSTEM

MODEL	CODE	ELECTRICAL DATA				MODEL MCE	DNA	DNM	WEIGHT Kg
		VOLTAGE 50 Hz	P2 NOMINAL		In A				
			KW	HP					
NKM-GE 40-250/245/A/BAQE/ 2,2 /4 MCE30/P	60192059	3x400 V	2,2	3,0	6,6	MCE30/P	65	40	89
NKM-GE40-250/260/A/BAQE/ 3 /4 MCE30/P	60192060	3x400 V	3,0	4,0	7,9	MCE30/P	65	40	98
NKM-GE50-250/263/A/BAQE/ 4/4 MCE30/P	60192061	3x400 V	4,0	5,5	10,0	MCE30/P	65	50	105
NKM-GE65-250/263/A/BAQE/ 5,5 /4MCE55/P	60192062	3x400 V	5,5	7,5	13,4	MCE55/P	80	65	168
NKM-GE65-315/279/A/BAQE/ 7,5 /4MCE110/P	60167386	3x400 V	7,5	10,0	17,9	MCE110/P	80	65	195
NKM-GE65-315/309/A/BAQE/11/4 MCE110/P	60167387	3x400 V	11,0	15,0	27,2	MCE110/P	80	65	263
NKM-GE80-250/240/A/BAQE/7,5/4MCE110/P	60167388	3x400 V	7,5	10,0	17,9	MCE110/P	100	80	185
NKM-GE80-250/270/A/BAQE/11/4 MCE110/P	60167389	3x400 V	11,0	15,0	27,2	MCE110/P	100	80	237
NKM-GE80-315/305/A/BAQE/15/4 MCE150/P	60167390	3x400 V	15,0	20,0	36,5	MCE150/P	100	80	294
NKM-GE100-250/250/A/BAQE/11/4 MCE110/P	60167391	3x400 V	11,0	15,0	27,2	MCE110/P	125	100	245
NKM-GE100-250/270/A/BAQE/15/4MCE150/P	60167392	3x400 V	15,0	20,0	36,5	MCE150/P	125	100	268
NKM-GE125-250/243/A/BAQE/15 /4 MCE150/P	60167393	3x400 V	15,0	20,0	36,5	MCE150/P	150	125	305

# NKP-GE WITH MCE/P

ENBLOC CENTRIFUGAL PUMPS WITH INVERTER



## NKP-GE 2 POLES WITH MCE/P - FOR PRESSURIZATION SYSTEM

MODEL	CODE	ELECTRICAL DATA				MODEL MCE	DNA	DNM	WEIGHT Kg
		VOLTAGE 50 Hz	P2 NOMINAL		In A				
			KW	HP					
NKP-GE32-125.1/125/A/BAQE /1.5/2 MCE11/P	60192063	1 x 230V	1,5	2,0	13,4	MCE11/P	50	32	56
NKP-GE 32-125.1/140/A/BAQE/2.2/2 MCE15/P	60192064	1 x 230V	2,2	3,0	18,5	MCE15/P	50	32	58
NKP-GE 32-125/130/A/BAQE / 2.2 /2 MCE15/P	60192065	1 x 230V	2,2	3,0	18,6	MCE15/P	50	32	58
NKP-GE 32-125/142/A/BAQE / 3 /2 MCE30/P	60192066	3 x 400V	3,0	4,0	7,0	MCE30/P	50	32	76
NKP-GE 32-160.1 155/A/BAQE/2.2/2 MCE15/P	60192067	1 x 230V	2,2	3,0	19,4	MCE15/P	50	32	53
NKP-GE 32-160.1 166/A/BAQE /3/2 MCE30/P	60192068	3 x 400V	3,0	4,0	6,7	MCE30/P	50	32	70
NKP-GE 32-160.1 177A/BAQE /4/2 MCE55/P	60192069	3 x 400V	4	5,5	8,5	MCE55/P	50	32	90,6
NKP-GE 32-160/151/A/BAQE/3/2 MCE30/P	60192070	3 x 400V	3,0	4,0	7,1	MCE30/P	50	32	70
NKP-GE 32-160/163/A/BAQE/4/2 MCE55/P	60192071	3 x 400V	4,0	5,5	8,9	MCE55/P	50	32	92
NKP-GE 32-160/177/A/BAQE /5,5/2MCE55/P	60192072	3 x 400V	5,5	7,5	12,7	MCE55/P	50	32	114
NKP-GE 32-200.1 188/A/BAQE/4/2 MCE55/P	60192073	3 x 400V	5,5	7,5	9,1	MCE30/P	50	32	92
NKP-GE32-200.1 205/A/BAQE/5,5/2 MCE55/P	60192074	3 x 400V	4,0	5,5	11,4	MCE55/P	50	32	114
NKP-GE 32-200/190/A/BAQE/5.5 /2MCE55/P	60192075	3 x 400V	5,5	7,5	12,4	MCE55/P	50	32	126
NKP-GE 32-200/210/A/BAQE/7.5/2MCE55/P	60167394	3 x 400V	7,5	10,0	16,5	MCE110/P	50	32	135
NKP-GE 40-125/120/A/BAQE/2.2/2MCE22/P	60192076	1 x 230V	2,2	3,0	20,6	MCE22/P	65	40	74
NKP-GE 40-125/130/A/BAQE/3/2 MCE30/P	60192077	3 x 400V	3,0	4,0	7,2	MCE30/P	65	40	85
NKP-GE 40-125/139/A/BAQE/4/2 MCE55/P	60192078	3 x 400V	4,0	5,5	9,6	MCE55/P	65	40	107
NKP-GE 40-160/158/A/BAQE/5,5/2MCE55/P	60192079	3 x 400V	5,5	7,5	12,4	MCE55/P	65	40	119
NKP-GE40-160/172/A/BAQE/7,5/2MCE55/P	60167395	3 x 400V	7,5	10,0	16,5	MCE110/P	65	40	127
NKP-GE 40-200/210/A/BAQE/11/2 MCE110/P	60167396	3 x 400V	11,0	15,0	24,9	MCE110/P	65	40	207
NKP-GE40-250/230/A/BAQE/15/2 MCE150/P	60167397	3 x 400V	15,0	20,0	34,6	MCE150/P	65	40	220
NKP-GE 50-125/125/A/BAQE/4/2 MCE55/P	60192080	3 x 400V	4,0	5,5	9,8	MCE55/P	65	50	122
NKP-GE50-125/135/A/BAQE/5,5 /2 MCE55/P	60192081	3 x 400V	5,5	7,5	12,6	MCE55/P	65	50	124
NKP-GE50-125/144/A/BAQE/7,5/2MCE55/P	60167398	3 x 400V	7,5	10,0	16,1	MCE55/P	65	50	133
NKP-GE50-160/153/A/BAQE/7.5/2MCE110/P	60167399	3 x 400V	7,5	10,0	17,4	MCE110/P	65	50	101
NKP-GE50-160/169/A/BAQE/11/2 MCE110/P	60167400	3 x 400V	11,0	15,0	24,0	MCE110/P	65	50	132
NKP-GE 50-200/200/A/BAQE/15/2 MCE150/P	60167401	3 x 400V	15,0	20,0	32,5	MCE150/P	65	50	216
NKP-GE 65-125/127/A/BAQE/5,5/2MCE55/P	60192082	3 x 400V	5,5	7,5	12,8	MCE55/P	80	65	122
NKP-GE65-125/137/A/BAQE/7,5/2MCE110/P	60167402	3 x 400V	7,5	10,0	17,4	MCE110/P	80	65	131
NKP-GE65-160/157/A/BAQE/11/2MCE110/P	60167403	3 x 400V	11,0	15,0	23,4	MCE110/P	80	65	202
NKP-GE65-160/173/A/BAQE/15/2MCE150/P	60167404	3 x 400V	15,0	20,0	33,5	MCE150/P	80	65	212
NKP-GE80-160/147-127/A/BAQE/11/2MCE110/P	60167405	3 x 400V	11,0	15,0	24,1	MCE110/P	100	80	215
NKP-GE 80-160/153/A/BAQE/15/2 MCE150/P	60167406	3 x 400V	15,0	20,0	32,6	MCE150/P	100	80	221

COMMAND AND  
CONTROL SYSTEMS

CIRCULATORS AND  
IN-LINE PUMPS

MULTISTAGE CENTRIFUGAL  
AND SELF-PRIMING PUMPS

SWIMMING POOL, POND AND  
SALT WATER PUMPS

CENTRIFUGAL PUMPS

SUBMERSIBLE PUMPS

SUBMERSIBLE PUMPS  
AND SUBMERSIBLE MOTORS

PRESSURE UNITS

# STANDARDISED CENTRIFUGAL PUMPS ON SKID WITH INVERTER FOR PRESSURIZATION SYSTEM

PERFORMANCE RANGE

## KDNE 4 POLES WITH MCE/P

≈ 1450 1/min

MODEL	Q (m³/h) (l/min)	0	12	18	24	30	36	42	48	54	60	66	72	78	84	90	102	114	120	150	180	210	
		0	200	300	400	500	600	700	800	900	1000	1100	1200	1300	1400	1500	1700	1900	2000	2500	3000	3500	
KDNE 40-250/240/A/BAQE/1/3/4 MCE30/P	H (m)	19.1	19	18.2	17	15.5																	
KDNE 50-250/263/A/BAQE/1/5,5/4 MCE55/P		23	23	22.9	22.8	22.5	21.7	20.6	19.4	17.5													
KDNE 65-250/240/A/BAQE/1/5,5/4 MCE55/P		19			19	18.9	18.5	18.1	17.5	16.8	16	14.7	13.6										
KDNE 65-250/263/A/BAQE/1/7,5/4 MCE110/P		23.2			23	23	22.9	22.5	22.2	21.6	20.8	19.8	18.6	17.4	16								
KDNE 65-315/260/A/BAQE/1/7,5/4 MCE110/P		22.3			22.2	22.1	22	21.5	21	20.5	20	19.2	18.4	17	16	15							
KDNE 65-315/290/A/BAQE/1/11/4 MCE110/P		28.2			28.2	28.1	28	27.8	27.3	27	26.5	25.5	25	24	23.1	22	19.5						
KDNE 65-315/320/A/BAQE/1/15/4 MCE150/P		35.7			35.4	35.3	35.2	35.1	35	34.8	34.5	33.8	33.5	32.5	31.5	30.8	28	24.8					
KDNE 80-250/230/A/BAQE/1/7,5/4 MCE110/P		17.3						17.3	17.2	17.1	17	16.9	16.8	16.5	16	15.5	14.3	12.4					
KDNE 80-250/260/A/BAQE/1/11/4 MCE110/P		22.6						22.5	22.5	22.4	22.3	22.2	22.1	22	21.8	21.4	20.6	19.6	19	15.1			
KDNE 80-250/270/A/BAQE/1/15/4 MCE150/P		24.5						24.4	24.4	24.4	24.3	24.2	24.1	24	23.7	23.3	22.4	21.4	20.7	16.3			
KDNE 80-315/290/A/BAQE/1/15/4 MCE150/P		27.8							27.8	27.8	27.7	27.7	27.6	27.6	27.5	27.4	26.5	25	24.6	19.1			
KDNE100-250/260/A/BAQE/1/15/4 MCE150/P		22.3									22.1	22.1	22.1	22	21.9	21.8	21.7	21.5	21.4	19.8	17.7	15.1	
KDNE100-315/275/A/BAQE/1/15/4 MCE150/P		25.1									25	25	25	24.9	24.8	24.7	24.6	24.4	24	22	19		

# ENBLOC CENTRIFUGAL PUMPS WITH INVERTER - FOR PRESSURIZATION SYSTEM

PERFORMANCE RANGE

## KDNE 2 POLES WITH MCE/P

≈ 2900 1/min

MODEL	Q (m³/h) (l/min)	H (m)																							
		0	6	12	18	24	30	36	42	48	54	60	66	72	78	84	90	102	114	120	150	180	210	240	
KDNE 32-125.1/130/A/BAQE/1/2.2/2 MCE22/P		22.3	22.2	21.3	19																				
KDNE 32-125.1/140/A/BAQE/1/3/2 MCE30/P		26.5	26.4	25.6	23.4	20.1																			
KDNE 32-125/125/A/BAQE/1/2,2/2 MCE22/P		20.9		20.1	18.9	16.9	13.5																		
KDNE 32-125/130/A/BAQE/1/3/2 MCE30/P		22.9		22	21	19.1	16.2																		
KDNE 32-125/142/A/BAQE/1/4/2 MCE55/P		27.8		27	26.1	24.5	21.7	18																	
KDNE 32-160.1/137/A/BAQE/1/1,5/2 MCE15/P		21.5	21.2	19.3																					
KDNE 32-160.1/145/A/BAQE/1/2,2/2 MCE22/P		24.7	24.5	22.3	16.5																				
KDNE 32-160.1/153/A/BAQE/1/3/2 MCE30/P		28.3	28	26	20.5																				
KDNE 32-160.1/177/A/BAQE/1/5,5/2 MCE55/P		39.5	39.3	38.2	34.5	26																			
KDNE 32-160/145/A/BAQE/1/3/2 MCE30/P		27		25.8	23.9	21.2	16.9																		
KDNE 32-160/161/A/BAQE/1/5,5/2 MCE55/P		34		33	31.7	29.1	25.5																		
KDNE 32-160/177/A/BAQE/1/7,5/2 MCE110/P		41.8		41.5	40.5	38.4	35.3	31.4																	
KDNE 32-200.1/170/A/BAQE/1/3/2 MCE30/P		34.3	34.2	31.9	23.5																				
KDNE 32-200.1/190/A/BAQE/1/5,5/2 MCE55/P		45.3	44.7	41.5	35.5																				
KDNE 32-200.1/207/A/BAQE/1/7,5/2 MCE110/P		55.3	55	51.8	46.4	37																			
KDNE 32-200/180/A/BAQE/1/5,5/2 MCE55/P		39		38.5	36.5	32.5	28																		
KDNE 32-200/200/A/BAQE/1/7,5/2 MCE110/P		51		49	48	45	40.5	35																	
KDNE 32-200/210/A/BAQE/1/11/2 MCE110/P		57		56	55	52.5	48.5	43	36																
KDNE 32-200/219/A/BAQE/1/15/2 MCE150/P		63		62	61	59	56.5	52.5	46.5	39.5															
KDNE 40-125/142/A/BAQE/1/5,5/2 MCE55/P		26.8		26.6	26.4	26	25.3	24.4	23	21.4	19.4	17													
KDNE 40-160/145/A/BAQE/1/5,5/2 MCE55/P		27.5			27.4	27	25.7	24.2	22.1	19.5															
KDNE 40-160/161/A/BAQE/1/7,5/2 MCE110/P		34.5			34.5	34.4	33.7	32.3	30.5	28.5	25.8	22.5													
KDNE 40-160/177/A/BAQE/1/11/2 MCE110/P		42.6			42.5	42.4	42	41.5	40	38.5	35	33	30												
KDNE 40-200/180/A/BAQE/1/7,5/2 MCE110/P		38.8			38.5	38	37	35	32.5	29	25														
KDNE 40-200/200/A/BAQE/1/11/2 MCE110/P		48.7			48.4	48.2	47.5	46.5	44	41.5	38.5	34.5													
KDNE 40-200/219/A/BAQE/1/15/2 MCE150/P		60			59.8	59.7	59.4	59	57	55	52.5	49.5	46	40											
KDNE 40-250/220/A/BAQE/1/15/2 MCE150/P		63.1			62.8	62.5	61	59	57	55	52	48													
KDNE 50-125/139/A/BAQE/1/7,5/2 MCE110/P		24.7					24.5	24.3	24	23.5	23	22.4	21.6	20.8	20	19.2	18	15.5							
KDNE 50-125/144/A/BAQE/1/11/2 MCE110/P		25.9					26.5	26.4	26.1	25.6	25.1	24.5	24	23.2	22.3	21.5	20.5	17.8	15						
KDNE 50-160/145/A/BAQE/1/7,5/2 MCE110/P		27.2					27	26.9	26.6	26.4	25.5	25	23.8	23	21.5	20.5	19								
KDNE 50-160/161/A/BAQE/1/11/2 MCE110/P		33.8					33.7	33.7	33.6	33.6	33.3	32.5	31.8	31	29.8	28.5	27.5								
KDNE 50-160/177/A/BAQE/1/15/2 MCE150/P		41.6					41.5	41.5	41.3	41.2	41	40.6	40.5	39.5	38.8	38	36.7	33.5							
KDNE 50-200/180/A/BAQE/1/11/2 MCE110/P		42.5					42	41.7	41.4	40.5	39.5	38	36	34	32	29									
KDNE 50-200/190/A/BAQE/1/15/2 MCE150/P		47.2					46.8	46.6	46	45.7	44.5	43.5	42	40	38	35.5	33								
KDNE 65-125/130/A/BAQE/1/7,5/2 MCE110/P		21								19.6	19.5	19.1	18.9	18.5	18	17.5	17	15.7	14.2	13.2					
KDNE 65-125/144/A/BAQE/1/11/2 MCE110/P		25.6								25.5	25.4	25.2	25	24.6	24.3	24	23.4	22.5	21.1	20.2	16				
KDNE 65-160/137/A/BAQE/1/7,5/2 MCE110/P		23.1								22.4	22	21.7	21.3	20.5	19.7	19	18	16							
KDNE 65-160/153/A/BAQE/1/11/2 MCE110/P		29.1								28.8	28.5	28.6	28.5	28	27.5	26.6	26	24	22	21					
KDNE 65-160/169/A/BAQE/1/15/2 MCE150/P		36.4								36.3	36.2	36.1	36	35.7	35.3	34.7	34	32.7	31	30					
KDNE 65-200/170/A/BAQE/1/15/2 MCE150/P		37.2								36.8	36.7	36.6	36.5	36	35	34	32.5	30	27	25					
KDNE 80-160/153-136/A/BAQE/1/15/2 MCE150/P		25.6														24.5	23.8	23	22.5	20.2	17.5	15	11.8		

D+CONNECT

COMMAND AND CONTROL SYSTEMS

CIRCULATORS AND IN-LINE PUMPS

MULTISTAGE CENTRIFUGAL AND SELF-PRIMING PUMPS

SWIMMING POOL, POND AND SALT WATER PUMPS

CENTRIFUGAL PUMPS

SUBMERSIBLE PUMPS

SUBMERSIBLE PUMPS AND SUBMERSIBLE MOTORS

PRESSURE UNITS

# KDNE WITH MCE/P

STANDARDISED CENTRIFUGAL PUMPS ON SKID WITH INVERTER



Standardised centrifugal pumps on skid with elastic coupling, electronics designed for a wide range of applications such as:

- homes;
- apartment blocks;
- camp sites;
- swimming pools;
- farms;
- well water supply;
- irrigation for greenhouses, gardens, agriculture;
- re-use of rainwater;
- industrial systems.

Highly versatile pumps thanks to the use of the DAB **MCE/P** inverter, to guarantee performance able to automatically adapt to the various system requirements, maintaining constant pressure. Pressure sensor included. Spiral single-stage body in cast iron according to DIN-EN 733 (ex DIN 24255), cast iron seal cover and motor support, flanges according to DIN 2533 (DIN 2532 for DN 200). Cast iron impeller, sealed and dynamically balanced with axial thrust compensation via balancing holes, operating (on request) on interchangeable wear rings. Pump shaft in stainless steel mounted on two generously sized ball bearings, permanently lubricated and housed in a special chamber inside the support. Standard seal: standardised mechanical seal according to DIN 24960 in carbon/silicon carbide with O-rings in EPDM. On request, packing seals are available, with hydraulic lubrication ring and gland in two easily removable parts. Sealed, asynchronous motor cooled by external ventilation; 2-pole or 4-pole. Rotor mounted on generously sized ball bearings to ensure silent and durable operation. Electrical protection: according to standards transposed into the ELECTROMAGNETIC COMPATIBILITY DIRECTIVE EEC 89/336 and subsequent amendments, LOW VOLTAGE DIRECTIVE EEC 73/23 and subsequent amendments and standards CEI 2-3.

**Construction design** B3

**Speed of rotation** 1450 - 2900 1/min.

**Operating range**

from 1 a 440 m<sup>3</sup>/h with head up to 70 meters

**Liquid temp. range** from -10°C to +140°C.

**Pumped liquid** clean, free from solid or abrasive substances, not viscous, not aggressive, not crystallised and chemically neutral, characteristics similar to water.

**Max. ambient temperature** +40°C

**Maximum operating pressure**

16 bar - 1600 kPa (per il DN 200 max 10 bar).

**Protection rating** IP 55

**Thermal category** F

**Flanging**

PN 16 DIN 2533

PN 10 DIN 2532 per DN 200

**Installation** fixed horizontally.

IE3 ≥ 0,75 kW

**D+CONNECT**

PAG. 5

MCE/P  
PAG. 23

ACCESSORIES  
PAG. 207

## KDNE 4 POLES WITH MCE/P - FOR PRESSURIZATION SYSTEM

MODEL	CODE	ELECTRICAL DATA			MODEL MCE	DNA	DNM	WEIGHT KG	
		VOLTAGE 50 Hz	P2 NOMINAL						In A
			kW	HP					
KDNE 40-250/240/A/BAQE/1/3/4 MCE30/P	60192083	3 x 400V	3	4	3	MCE30/P	65	40	158
KDNE 40-250/250/A/BAQE/1/4/4 MCE55/P	60192084	3 x 400V	4	5,5	4	MCE55/P	65	40	209
KDNE 50-250/263/A/BAQE/1/5,5/4 MCE55/P	60192085	3 x 400V	5,5	7,5	5,5	MCE55/P	65	50	182
KDNE 65-250/240/A/BAQE/1/5,5/4 MCE55/P	60192086	3 x 400V	5,5	7,5	5,5	MCE55/P	80	65	210
KDNE 65-250/263/A/BAQE/1/7,5/4 MCE110/P	60167407	3 x 400V	7,5	10	7,5	MCE110/P	80	65	270
KDNE 65-315/260/A/BAQE/1/7,5/4 MCE110/P	60167408	3 x 400V	7,5	10	7,5	MCE110/P	80	65	305
KDNE 65-315/290/A/BAQE/1/11/4 MCE110/P	60167409	3 x 400V	11	15	11	MCE110/P	80	65	310
KDNE 65-315/320/A/BAQE/1/15/4 MCE150/P	60167411	3 x 400V	15	20	15	MCE150/P	80	65	310
KDNE 80-250/230/A/BAQE/1/7,5/4 MCE110/P	60167412	3 x 400V	7,5	10	7,5	MCE110/P	100	80	232
KDNE 80-250/260/A/BAQE/1/11/4 MCE110/P	60167413	3 x 400V	11	15	11	MCE110/P	100	80	271
KDNE 80-250/270/A/BAQE/1/15/4 MCE150/P	60167414	3 x 400V	15	20	15	MCE150/P	100	80	290
KDNE 80-315/290/A/BAQE/1/15/4 MCE150/P	60167415	3 x 400V	15	20	15	MCE150/P	100	80	403
KDNE100-250/260/A/BAQE/1/15/4 MCE150/P	60167416	3 x 400V	15	20	15	MCE150/P	125	100	313
KDNE100-315/275/A/BAQE/1/15/4 MCE150/P	60167417	3 x 400V	15	20	15	MCE150/P	125	100	313

# KDNE WITH MCE/P

STANDARDISED CENTRIFUGAL PUMPS ON SKID WITH INVERTER



## KDNE 2 POLES WITH MCE/P - FOR PRESSURIZATION SYSTEM

MODEL	CODE	ELECTRICAL DATA				MODEL MCE	DNA	DNM	WEIGHT Kg
		VOLTAGE 50 Hz	P2 NOMINAL		In A				
			KW	HP					
KDNE 32-125.1/130/A/BAQE/1/2,2/2 MCE22/P	60192087	1x220-240 V	2,2	3	2,2	MCE22/P	50	32	104
KDNE 32-125.1/140/A/BAQE/1/3/2 MCE30/P	60192088	3x 400 V	3	4	3	MCE30/P	50	32	111
KDNE 32-125/125/A/BAQE/1/2,2/2 MCE22/P	60192089	1x220-240 V	2,2	3	2,2	MCE22/P	50	32	97
KDNE 32-125/130/A/BAQE/1/3/2 MCE30/P	60192090	3x 400 V	3	4	3	MCE30/P	50	32	105
KDNE 32-125/142/A/BAQE/1/4/2 MCE55/P	60192091	3x 400 V	4	5,5	4	MCE55/P	50	32	126
KDNE 32-160.1/137/A/BAQE/1/1,5/2 MCE15/P	60192092	1x220-240 V	1,5	2	1,5	MCE15/P	50	32	98
KDNE 32-160.1/145/A/BAQE/1/2,2/2 MCE22/P	60192093	1x220-240 V	2,2	3	2,2	MCE22/P	50	32	106
KDNE 32-160.1/153/A/BAQE/1/3/2 MCE30/P	60192094	3x 400 V	3	4	3	MCE30/P	50	32	111
KDNE 32-160.1/177/A/BAQE/1/5,5/2 MCE55/P	60192095	3x 400 V	5,5	7,5	5,5	MCE55/P	50	32	145
KDNE 32-160/145/A/BAQE/1/3/2 MCE30/P	60192096	3x 400 V	3	4	3	MCE30/P	50	32	111
KDNE 32-160/161/A/BAQE/1/5,5/2 MCE55/P	60192097	3x 400 V	5,5	7,5	5,5	MCE55/P	50	32	145
KDNE 32-160/177/A/BAQE/1/7,5/2 MCE110/P	60167423	3x 400 V	7,5	10	7,5	MCE110/P	50	32	152
KDNE 32-200.1/170/A/BAQE/1/3/2 MCE30/P	60192099	3x 400 V	3	4	3	MCE30/P	50	32	149
KDNE 32-200.1/190/A/BAQE/1/5,5/2 MCE55/P	60192098	3x 400 V	5,5	7,5	5,5	MCE55/P	50	32	152
KDNE 32-200.1/207/A/BAQE/1/7,5/2 MCE110/P	60167424	3x 400 V	7,5	10	7,5	MCE110/P	50	32	179
KDNE 32-200/180/A/BAQE/1/5,5/2 MCE55/P	60192100	3x 400 V	5,5	7,5	5,5	MCE55/P	50	32	152
KDNE 32-200/200/A/BAQE/1/7,5/2 MCE110/P	60167425	3x 400 V	7,5	10	7,5	MCE110/P	50	32	190
KDNE 32-200/210/A/BAQE/1/ 11/2 MCE110/P	60167426	3x 400 V	11	15	11	MCE110/P	50	32	250
KDNE 32-200/219/A/BAQE/1/15/2 MCE150/P	60167427	3x 400 V	15	20	15	MCE150/P	50	32	261
KDNE 40-125/142/A/BAQE/1/5,5/2 MCE55/P	60192101	3x 400 V	5,5	7,5	5,5	MCE55/P	65	40	143
KDNE 40-160/145/A/BAQE/1/5,5/2 MCE55/P	60192102	3x 400 V	5,5	7,5	5,5	MCE55/P	65	40	169
KDNE 40-160/161/A/BAQE/1/7,5/2 MCE110/P	60167439	3x 400 V	7,5	10	7,5	MCE110/P	65	40	178
KDNE 40-160/177/A/BAQE/1/11/2 MCE110/P	60167440	3x 400 V	11	15	11	MCE110/P	65	40	186
KDNE 40-200/180/A/BAQE/1/7,5/2 MCE110/P	60167441	3x 400 V	7,5	10	7,5	MCE110/P	65	40	160
KDNE 40-200/200/A/BAQE/1/11/2 MCE110/P	60167442	3x 400 V	11	15	11	MCE110/P	65	40	234
KDNE 40-200/219/A/BAQE/1/15/2 MCE150/P	60167443	3x 400 V	15	20	15	MCE150/P	65	40	244
KDNE 40-250/220/A/BAQE/1/15/2 MCE150/P	60167445	3x 400 V	15	20	15	MCE150/P	65	40	291
KDNE 50-125/139/A/BAQE/1/7,5/2 MCE110/P	60167446	3x 400 V	7,5	10	7,5	MCE110/P	65	50	156
KDNE 50-125/144/A/BAQE/1/11/2 MCE110/P	60167447	3x 400 V	11	15	11	MCE110/P	65	50	156
KDNE 50-160/145/A/BAQE/1/7,5/2 MCE110/P	60167448	3x 400 V	7,5	10	7,5	MCE110/P	65	50	190
KDNE 50-160/161/A/BAQE/1/11/2 MCE110/P	60167449	3x 400 V	11	15	11	MCE110/P	65	50	201
KDNE 50-160/177/A/BAQE/1/15/2 MCE150/P	60167450	3x 400 V	15	20	15	MCE150/P	65	50	213
KDNE 50-200/180/A/BAQE/1/11/2 MCE110/P	60167451	3x 400 V	11	15	11	MCE110/P	65	50	199
KDNE 50-200/190/A/BAQE/1/15/2 MCE150/P	60167452	3x 400 V	15	20	15	MCE150/P	65	50	293
KDNE 65-125/130/A/BAQE/1/7,5/2 MCE110/P	60167453	3x 400 V	7,5	10	7,5	MCE110/P	80	65	159
KDNE 65-125/144/A/BAQE/1/11/2 MCE110/P	60167454	3x 400 V	11	15	11	MCE110/P	80	65	188
KDNE 65-160/137/A/BAQE/1/7,5/2 MCE110/P	60167455	3x 400 V	7,5	10	7,5	MCE110/P	80	65	186
KDNE 65-160/153/A/BAQE/1/11/2 MCE110/P	60167456	3x 400 V	11	15	11	MCE110/P	80	65	196
KDNE 65-160/169/A/BAQE/1/15/2 MCE150/P	60167457	3x 400 V	15	20	15	MCE150/P	80	65	233
KDNE 65-200/170/A/BAQE/1/15/2 MCE150/P	60167458	3x 400 V	15	20	15	MCE150/P	80	65	292
KDNE 80-160/153-136/A/BAQE/1/15/2 MCE150/P	60167459	3x 400 V	15	20	15	MCE150/P	100	80	311

COMMAND AND CONTROL SYSTEMS

CIRCULATORS AND IN-LINE PUMPS

MULTISTAGE CENTRIFUGAL AND SELF-PRIMING PUMPS

SWIMMING POOL, POND AND SALT WATER PUMPS

CENTRIFUGAL PUMPS

SUBMERSIBLE PUMPS

SUBMERSIBLE PUMPS AND SUBMERSIBLE MOTORS

PRESSURE UNITS



# KVCE 30-50-80-120

MULTISTAGE CENTRIFUGAL PUMPS WITH VERTICAL AXIS WITH INVERTER MCE/P



Vertical multistage centrifugal pump suitable for small and medium consumption water systems. Particularly versatile thanks to the use of the **MCE/P** inverter, this pump guarantees the automatic adjustment of its performance to the various system requirements, while maintaining constant the differential pressure. Suitable for booster sets, feeding of drip and spray irrigation systems and washing systems. Innovative and sturdy design. Discharge/suction body in technopolymer and IN-LINE suction and discharge ports with threaded metal insert.

Impellers, diffuser bodies and diffusers in technopolymer, entirely stainless.

Pump liner, wear rings and seal plate in AISI 304 stainless steel. Mechanical seal in carbon/ceramic, mounted on motor shaft extension in stainless steel AISI 303. Asynchronous, closed motor cooled by external ventilation. Motor shaft mounted on oversized greased sealed-for-life ball bearings to ensure silent running and long life.

Construction to CEI 2-3 and CEI 61-69 (EN 60335-2-41)

**Protection rating** IP 55.

**Insulation class** F.

**Standard voltage**

single-phase 1x220-240 V / 50/60 Hz  
three-phase 3x400 V / 50 Hz

**Operating range**

from 1 to 12 m<sup>3</sup>/h with head up to 107 meters.

**Pumped liquid** clean, free from solids or abrasive substances, not viscous, not aggressive, not crystallised and chemically neutral, close to the properties of water.

**Liquid temperature range**

from 0°C to +35°C for domestic use (Safety standards EN 60335-2-41).  
from 0°C to +40°C for other uses.

**Maximum ambient temperature** +40°C.

**Maximum working pressure** 12 bar (1200 kPa).

**Installation** fixed, in a vertical position.



PAG. 5

MCE/P  
PAG. 23

ACCESSORIES  
PAG. 207

## KVCE 30-50-80-120 WITH MCE/P - FOR PRESSURIZATION SYSTEM

MODEL	CODE	ELECTRICAL DATA			HYDRAULIC DATA																	DNA GAS	DNM GAS	H mm	Weight KG		
		VOLTAGE 50 Hz	P2 NOMINAL kW	In A	Q=m <sup>3</sup> /h																						
					Q=l/min	0	0,6	1,2	1,8	2,4	3	3,3	3,9	4,8	5,4	6	7,2	8,4	9	9,6	10,8					12	
KVCE 35-30 M MCE11/P	60183574	1 x 230V	0,45	0,6	7,6	40,2	39,3	37,3	34,1	29,8	24,3	21,0	13,5										1"¼	1"¼	560	19,5	
KVCE 45-30 M MCE11/P	60183658	1 x 230V	0,65	0,88	8,4	49,7	48,7	46,5	43,1	38,4	32,1	28,5	19,6											1"¼	1"¼	560	19,9
KVCE 50-30 M MCE11/P	60183659	1 x 230V	0,75	1,0	9,6	61,5	59,9	56,8	52,2	46,0	38,0	33,5	22,7											1"¼	1"¼	652	22,5
KVCE 60-30 M MCE11/P	60183660	1 x 230V	0,9	1,2	10,7	69,6	67,6	64,0	58,5	51,1	41,8	36,2	23,8											1"¼	1"¼	652	22,3
KVCE 65-30 M MCE11/P	60183661	1 x 230V	1	1,36	11,6	78,4	76,8	73,5	68,4	61,2	51,9	46,0	33,3											1"¼	1"¼	679	23,9
KVCE 30-50 M MCE11/P	60144871	1 x 230V	0,55	0,75	8,51	41,1	40,3	39,0	37,3	34,7	31,6	29,7	25,3	17,1										1"¼	1"¼	506	19,1
KVCE 40-50 M MCE11/P	60144872	1 x 230V	0,8	1,1	10,2	54,9	53,7	52,0	49,7	46,3	42,1	39,6	33,7	22,9										1"¼	1"¼	562	22,4
KVCE 55-50 M MCE11/P	60144873	1 x 230V	1,0	1,4	12	68,6	67,1	65,0	62,1	57,9	52,7	49,5	42,1	28,6										1"¼	1"¼	562	22,4
KVCE 65-50 M MCE15/P	60144874	1 x 230V	1,1	1,5	14,6	82,3	80,6	78,0	74,6	69,4	63,2	59,4	50,6	34,3										1"¼	1"¼	655	26,4
KVCE 75-50 M MCE15/P	60144875	1 x 230V	1,5	2,0	16,6	96,0	94,0	91,0	87,0	81,0	73,8	69,3	59,0	40,0										1"¼	1"¼	655	26,4
KVCE 30-80 M MCE11/P	60183754	1 x 230V	0,9	1,2	10,2	36,9	36,9	36,6	36,1	35,3	34,3	33,6	32,2	29,5	27,8	25,5	20,3	14,2	10,7					1"¼	1"¼	505	18,7
KVCE 40-80 M MCE11/P	60183745	1 x 230V	1	1,36	12,4	50,1	49,7	49,0	48,0	46,7	45,1	44,2	42	38,5	35,7	32,5	25,5	17,1	12,5					1"¼	1"¼	560	23
KVCE 45-80 M MCE15/P	60183746	1 x 230V	1,5	2	15,5	64,6	64,5	63,9	63,0	61,7	60,0	59,0	56,7	52,5	49,3	45	37,1	26,8	21,1					1"¼	1"¼	634	23
KVCE 55-80 M MCE15/P	60183747	1 x 230V	1,85	2,5	17,8	76,1	75,8	75,1	73,9	72,2	70,0	68,5	66	60,5	56,7	52	41,8	29,5	22,7					1"¼	1"¼	727	27
KVCE 65-80 M MCE22/P	60183748	1 x 230V	2,2	3	19,9	88,6	88,0	86,9	85,5	83,5	81,2	80,0	76,5	71	67,0	62	51,1	37,9	30,5					1"¼	1"¼	727	27
KVCE 35-120 M MCE15/P	60144881	1 x 230V	1,1	1,5	16	46,2	46,1	45,7	45,3	44,8	44,0	43,7	42,7	40,9	39,3	37,4	33,7	29,4	26,8	24,2	18,0	11,0		1"¼	1"¼	505	23,8
KVCE 45-120 M MCE22/P	60144882	1 x 230V	1,84	2,5	19,5	62,4	62,0	61,4	60,8	60,1	59,1	58,6	57,5	55,3	53,4	51,4	46,2	40,6	37,5	34,0	26,3	17,0		1"¼	1"¼	635	29,0
KVCE 60-120 T MCE30P	60144883	3 x 400V	2,2	3,0	6,91	78,0	77,5	76,7	75,9	75,1	73,9	73,3	71,5	68,3	65,9	63,2	58,0	51,0	47	43,4	35,0	24,5		1"¼	1"¼	635	27,1
KVCE 70-120 T MCE30/P	60144884	3 x 400V	2,2	3,0	8,26	95,0	94,3	93,4	92,5	91,4	89,8	88,9	86,8	83,2	80,5	77,9	71,7	63,9	59,2	54,7	44,0	31,0		1"¼	1"¼	730	30,8
KVCE 85-120 T MCE30/P	60144885	3 x 400V	2,2	3,0	9,18	112,7	111,6	110,3	109,0	107,6	105,7	104,5	101,9	97,5	94,1	89,9	81,6	72,1	66,7	61,2	48,9	34,0		1"¼	1"¼	730	30,8

# NKVE 1-3-6-10-15-20 S

MULTISTAGE CENTRIFUGAL PUMPS WITH VERTICAL AXIS WITH INVERTER MCE/P



D+CONNECT

COMMAND AND CONTROL SYSTEMS

CIRCULATORS AND IN-LINE PUMPS

MULTISTAGE CENTRIFUGAL AND SELF-PRIMING PUMPS

SWIMMING POOL, POND AND SALT WATER PUMPS

CENTRIFUGAL PUMPS

SUBMERSIBLE PUMPS

SUBMERSIBLE PUMPS AND SUBMERSIBLE MOTORS

PRESSURE UNITS



DAB's NKVE 1, 3, 6, 10, 15, 20 S pumps are AISI 304 stainless steel multi-impeller vertical centrifugal pumps with coupling with MCE-P inverter installed as standard; designed for pressurization in civil and commercial environments, they can also be used in agriculture and in watering systems.

The pumps can be used for the recirculation of water in heating and air conditioning systems. They are particularly versatile, thanks to the use of the MCE-P inverter, which ensures performance levels capable of automatically adapting to the different needs of the system, keeping a constant pressure.

Pressure sensor supplied as standard. In all models, the parts in contact with the liquid are made of AISI 304 stainless steel (AISI 316 stainless steel, X version, only on request).

They are particularly versatile, thanks to the centre distance between the 2 in-line ports, designed to maximise interchangeability. Starting from 5.5 kW models, the silicon carbide-graphite mechanical seal can be removed without removing the motor.

Mechanical seals for aggressive liquids and different connections (round, oval, Victaulic, clamp flanges) available on request.

All the models are WRAS and ACS certified for use with drinking water. Rigid coupling to IE3 high energy efficiency electric motors.

**Operating range (flow rate and head)**

1 m<sup>3</sup>/h to 30 m<sup>3</sup>/h with head up to 320 m

**Type of pumped liquid** Clean, free of solids and abrasive substances, non-viscous, non-aggressive, non-crystallised and chemically neutral

**Maximum % of glycol** 30%

**Min. and max. supported liquid temperature**

-30 °C to +120 °C (EPDM)

-15 °C to +120 °C (Viton/FKM)

**Maximum ambient temperature** +50° C

**Maximum operating pressure bar / kPa**

25 bar / 2500 kPa

**Class of protection** IP 55

**Motor insulation class** F

**Impeller/s material**

AISI 304 stainless steel for NKV S

AISI 316 stainless steel for NKV X (only on request)

**Single phase power input** 1x230 V up to 2,2 kW

**Three phase power input**

380 - 415 V at 50 Hz from 3 kW

**Possible type of installation** Vertical position

**Special versions on request**

Yes, available with different types of mechanical seals for aggressive liquids and connections (round, oval, Victaulic, clamp flanges), **with parts in contact with the liquid in AISI 316 stainless steel (X versions)**, other voltages and frequencies, ATEX version



IE3 ≥ 0,75 kW



PAG. 5

MCE/P  
PAG. 23

ACCESSORIES  
PAG. 207



**HIGH EFFICIENCY**

The new NKVE pumps are supplied with IE3 class motors and comply with the highest energy efficiency standards on the water handling market.

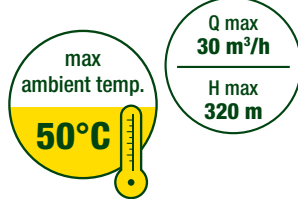

**PERFORMANCE FOR EVERY NEED**

They offer incredible application flexibility thanks to a complete performance range and the ability to work with ambient temperatures up to 50°C.



**ROBUSTNESS AND RELIABILITY**

All parts in contact with liquids are made of AISI 304 stainless steel (AISI 316 X versions). DAB construction quality guarantees solidity and greater resistance to wear and tear.

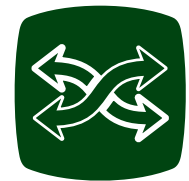

**THE EASIEST REPLACEMENT EVER**

In addition, the new range has been designed to simplify replacement thanks to the standard flanges and standard centre distances.

**NKVE 15 / 10 S 110 E1 IE3**

NOMINAL FLOW (m<sup>3</sup>/h)

NUMBER OF STAGES/IMPELLERS

MATERIALS\*: S=AISI 304; X=AISI 316

MOTOR POWER P2 kW x 10 (110 = 11kW)

**Mechanical seal Type (E1=STANDARD)**

E1=BQGE=Graphite/Silicon Carbide/AISI 316/EPDM

E2=QQGE=Sil. Carbide/Sil. Carbide/AISI 316/EPDM

V3=QQGV=Sil. Carbide/Sil. Carbide/AISI 316/FKM

V4=BQGV=Graphite/Sil. Carbide/AISI 316/FKM

E5=UUGE=Tungsten C/Tungsten C/AISI 316/EPDM

Motor efficiency

\*MATERIALS:

"S" version with pump body/impellers/diffusers in stainless steel AISI 304

"X" version with pump body/ impellers/diffusers in stainless steel AISI 316



# NKVE 1-3-6-10-15-20 S

MULTISTAGE CENTRIFUGAL PUMPS WITH VERTICAL AXIS WITH INVERTER MCE/P



## NKVE 1 S WITH MCE/P

MODEL	CODE	ELECTRICAL DATA				HYDRAULIC DATA							DNA	DNM	H mm	CENTRE DISTANCE mm	WEIGHT Kg
		VOLTAGE 50 Hz	P2 NOMINAL		In A	Q=m <sup>3</sup> /h	0	0.5	1	1.5	2	2.5					
			kW	HP		Q=l/min	0	8.3	16.7	25.0	33.3	42					
NKVE 1/03 S 003 M MCE11/P	60190488	1 x 230 V	0,4	0,5	5,5	H (m)	21,5	20,0	19,0	17,0	14,0	11,0	25	25	752	250	23,8
NKVE 1/05 S 003 M MCE11/P	60190489	1 x 230 V	0,4	0,5	5,5		35,0	33,0	30,5	27,0	22,5	17,0	25	25	797	250	24,8
NKVE 1/07 S 003 M MCE11/P	60190490	1 x 230 V	0,4	0,5	5,5		48,0	45,0	41,5	36,5	30,0	22,0	25	25	842	250	25,8
NKVE 1/09 S 005 M MCE11/P	60190491	1 x 230 V	0,6	0,8	7,2		61,5	58,0	53,0	47,0	39,0	28,5	25	25	887	250	27,2
NKVE 1/11 S 005 M MCE11/P	60190492	1 x 230 V	0,6	0,8	7,2		74,5	69,5	64,0	56,5	46,5	34,0	25	25	932	250	28,2
NKVE 1/13 S 007 M MCE11/P	60190493	1 x 230 V	0,8	1,0	8,1		89,5	84,5	77,5	68,5	57,0	42,0	25	25	993	250	32,5
NKVE 1/15 S 007 M MCE11/P	60190494	1 x 230 V	0,8	1,0	8,1		102,5	96,0	88,0	78,0	64,0	47,0	25	25	1038	250	33,0
NKVE 1/19 S 011 M MCE11/P	60190495	1 x 230 V	1,1	1,5	10,9		131,0	123,5	114,0	101,0	84,0	62,0	25	25	1128	250	36,6
NKVE 1/22 S 011 M MCE11/P	60190496	1 x 230 V	1,1	1,5	10,9		150,5	141,5	130,0	115,0	95,0	69,5	25	25	1195	250	38,1
NKVE 1/25 S 015 M MCE11/P	60190497	1 x 230 V	1,5	2,0	13,9		174,0	164,0	151,5	134,5	112,0	83,5	25	25	1308	250	43,0
NKVE 1/30 S 015 M MCE11/P	60190498	1 x 230 V	1,5	2,0	13,9		206,5	194,5	179,0	158,0	131,0	96,5	25	25	1420	250	45,0
NKVE 1/34 S 022 M MCE15/P	60190499	1 x 230 V	2,2	3,0	19,4		238,0	225,5	208,5	185,5	155,5	116,5	25	25	1510	250	49,0
NKVE 1/37 S 022 M MCE15/P	60190500	1 x 230 V	2,2	3,0	19,4		258,0	244,0	225,5	200,5	167,5	125,0	25	25	1578	250	50,5

## NKVE 3 S WITH MCE/P

MODEL	CODE	ELECTRICAL DATA				HYDRAULIC DATA										DNA	DNM	H mm	CENTRE DISTANCE mm	WEIGHT Kg
		VOLTAGE 50 Hz	P2 NOMINAL		In A	Q=m <sup>3</sup> /h	0	1	1.5	2	2.5	3	3.5	4	4.5					
			kW	HP		Q=l/min	0	16.7	25.0	33.3	42	50.0	58.3	67	75.0					
NKVE 3/04 S 003 M MCE11/P	60190501	1 x 230 V	0,4	0,5	5,5	H (m)	30,0	28,5	27,5	26,0	24,0	21,5	18,5	15,0	10,5	25	25	774	250	24,3
NKVE 3/06 S 005 M MCE11/P	60190502	1 x 230 V	0,6	0,8	5,5		44,5	42,5	40,5	38,5	35,5	32,0	27,0	21,5	15,0	25	25	819	250	25,7
NKVE 3/09 S 007 M MCE11/P	60190503	1 x 230 V	0,8	1,0	5,5		67,0	64,0	61,5	58,0	53,5	48,0	41,0	32,5	22,5	25	25	903	250	30,5
NKVE 3/11 S 011 M MCE11/P	60190504	1 x 230 V	1,1	1,5	7,2		82,5	79,5	76,5	72,5	67,0	60,5	52,0	42,0	29,5	25	25	948	250	33,1
NKVE 3/13 S 011 M MCE11/P	60190505	1 x 230 V	1,1	1,5	7,2		96,5	93,0	89,0	84,5	78,0	70,0	60,0	47,5	33,5	25	25	993	250	34,1
NKVE 3/15 S 015 M MCE11/P	60190506	1 x 230 V	1,5	2,0	8,1		112,5	109,0	105,0	99,5	92,5	83,0	71,5	58,0	41,5	25	25	1083	250	38,5
NKVE 3/17 S 015 M MCE11/P	60190507	1 x 230 V	1,5	2,0	8,1		127,0	122,5	118,0	111,5	103,5	93,0	80,0	64,0	45,5	25	25	1128	250	39,0
NKVE 3/21 S 022 M MCE15/P	60190508	1 x 230 V	2,2	3,0	10,9		158,5	153,5	148,0	140,5	130,5	118,0	102,0	83,0	60,0	25	25	1218	250	43,0
NKVE 3/25 S 022 T MCE30/P	60187820	3 x 380-415	2,2	3,0	10,9		187,5	181,0	174,5	165,5	153,5	138,0	119,0	96,0	68,5	25	25	1308	250	45,0
NKVE 3/29 S 030 T MCE30/P	60187821	3 x 380-415	3,0	4,0	13,9		220,0	213,5	206,5	196,5	183,5	166,0	144,0	117,5	86,0	25	25	1447	250	57,3
NKVE 3/33 S 030 T MCE30/P	60190509	3 x 380-415	3,0	4,0	13,9		249,5	242,0	234,0	222,0	206,5	187,0	162,0	131,5	95,5	25	25	1537	250	59,3

# NKVE 1-3-6-10-15-20 S

MULTISTAGE CENTRIFUGAL PUMPS WITH VERTICAL AXIS WITH INVERTER MCE/P



## NKVE 6 S WITH MCE/P

MODEL	CODE	ELECTRICAL DATA			HYDRAULIC DATA									DNA	DNM	H mm	CENTRE DISTANCE mm	WEIGHT Kg		
		VOLTAGE 50 Hz	P2 NOMINAL		In A	Q=m <sup>3</sup> /h	0	3	3.5	4	4.5	5	5.4						6	7
			kW	HP		Q=l/min	0	50.0	58.3	67	75.0	83.3	90						100.0	116.7
NKVE 6/02 S 003 M MCE11/P	60190510	1 x 230 V	0,4	0,5	5,5	H (m)	15,0	13,5	13,0	12,5	12,0	11,5	11,0	10,0	8,0	32	32	736	250	23,8
NKVE 6/04 S 005 M MCE11/P	60190511	1 x 230 V	0,6	0,8	7,2		29,5	26,0	25,0	24,0	22,5	21,5	20,5	18,5	14,5	32	32	788	250	25,2
NKVE 6/06 S 007 M MCE11/P	60190512	1 x 230 V	0,8	1,0	8,1		44,5	39,5	37,5	36,0	34,0	32,5	30,5	28,0	22,0	32	32	856	250	29,5
NKVE 6/09 S 011 M MCE11/P	60190513	1 x 230 V	1,1	1,5	10,9		67,0	59,0	56,5	54,0	51,5	48,5	46,0	42,5	33,5	32	32	934	250	32,6
NKVE 6/11 S 015 M MCE11/P	60190514	1 x 230 V	1,5	2,0	13,9		82,5	73,5	71,0	67,5	64,5	61,0	58,0	53,5	42,5	32	32	1031	250	37,5
NKVE 6/13 S 015 M MCE11/P	60190515	1 x 230 V	1,5	2,0	13,9		97,0	86,0	82,0	78,5	74,5	70,5	67,0	61,5	48,5	32	32	1083	250	38,5
NKVE 6/16 S 022 M MCE15/P	60190516	1 x 230 V	2,2	3,0	19,4		120,5	108,0	104,0	99,0	94,5	89,5	85,5	78,5	62,5	32	32	1161	250	42,0
NKVE 6/19 S 022 M MCE15/P	60190517	1 x 230 V	2,2	3,0	19,4		142,0	126,5	121,5	115,5	110,0	104,0	99,0	91,0	72,0	32	32	1239	250	43,5
NKVE 6/21 S 030 T MCE30/P	60190518	3 x 380-415	3,0	4,0	7,1		159,0	144,5	139,0	133,0	127,0	120,5	115,0	106,0	85,5	32	32	1340	250	54,8
NKVE 6/25 S 030 T MCE30/P	60190519	3 x 380-415	3,0	4,0	7,1		189,0	170,0	164,0	157,5	150,5	142,5	135,5	123,5	98,5	32	32	1444	250	56,8
NKVE 6/28 S 040 T MCE30/P	60190520	3 x 380-415	4,0	5,5	8,9		214,0	194,5	188,0	181,0	173,5	164,5	156,5	143,0	115,5	32	32	1522	250	62,0
NKVE 6/33 S 040 T MCE30/P	60190521	3 x 380-415	4,0	5,5	8,9		251,5	227,0	219,5	211,0	201,5	191,0	182,0	166,0	133,5	32	32	1652	250	65,0
NKVE 6/36 S 055 T MCE55/P	60190522	3 x 380-415	5,5	7,5	12,6		275,0	249,5	241,5	232,5	222,5	211,5	201,5	184,0	148,5	32	32	1928	250	93,1

## NKVE 10 S WITH MCE/P

MODEL	CODE	ELECTRICAL DATA			HYDRAULIC DATA														DNA	DNM	H mm	CENTRE DISTANCE mm	WEIGHT Kg
		VOLTAGE 50 Hz	P2 NOMINAL		In A	Q=m <sup>3</sup> /h	0	3	5	6	7	8	9	10	11	14							
			kW	HP		Q=l/min	0	50.0	83.3	100.0	116.7	133	150.0	166.7	183	233.3							
NKVE 10/02 S 007 M MCE11/P	60190523	1 x 230 V	0,8	1,0	8,1	H (m)	20,0	20,0	19,0	18,5	17,5	17,0	16,0	15,0	13,5	9,0	40	40	773	280	28,5		
NKVE 10/03 S 011 M MCE11/P	60185542	1 x 230 V	1,1	1,5	10,9		30,0	30,0	28,5	27,5	26,5	25,5	24,0	22,5	20,5	13,5	40	40	803	280	31,1		
NKVE 10/04 S 015 M MCE11/P	60190524	1 x 230 V	1,5	2,0	13,9		40,5	40,0	38,5	37,0	35,5	34,0	32,5	30,5	28,0	18,0	40	40	878	280	35,0		
NKVE 10/05 S 015 M MCE11/P	60190525	1 x 230 V	1,5	2,0	13,9		50,5	49,5	47,0	45,5	43,5	41,5	39,5	37,0	33,5	21,5	40	40	908	280	35,5		
NKVE 10/06 S 022 M MCE15/P	60188934	1 x 230 V	2,2	3,0	19,4		61,0	60,5	57,5	56,0	54,0	51,5	49,0	46,0	42,0	27,5	40	40	938	280	38,5		
NKVE 10/07 S 022 M MCE15/P	60190526	1 x 230 V	2,2	3,0	19,4		70,5	70,0	66,5	64,5	62,0	59,5	56,0	52,5	48,0	31,0	40	40	968	280	39,0		
NKVE 10/08 S 030 T MCE30/P	60190527	3 x 380-415	3,0	4,0	7,1		81,5	81,0	78,0	75,5	73,0	70,0	66,5	62,5	57,5	38,0	40	40	1047	280	50,3		
NKVE 10/09 S 030 T MCE30/P	60190528	3 x 380-415	3,0	4,0	7,1		91,5	91,0	87,5	84,5	81,5	78,0	74,0	69,5	64,0	42,0	40	40	1077	280	50,8		
NKVE 10/10 S 040 T MCE30/P	60190529	3 x 380-415	4,0	5,5	8,9		102,5	102,5	99,0	96,0	93,0	89,0	84,5	79,5	73,5	49,0	40	40	1107	280	55,0		
NKVE 10/12 S 040 T MCE30/P	60190530	3 x 380-415	4,0	5,5	8,9		123,0	122,5	117,5	114,0	110,0	105,5	100,5	94,0	87,0	57,5	40	40	1167	280	56,5		
NKVE 10/15 S 055 T MCE55/P	60190531	3 x 380-415	5,5	7,5	12,6		153,5	153,0	147,0	142,5	138,0	132,0	125,5	118,0	109,0	72,0	40	40	1454	280	85,1		
NKVE 10/17 S 055 T MCE55/P	60190532	3 x 380-415	5,5	7,5	12,6		173,5	172,5	165,5	160,5	155,0	148,5	141,0	132,5	122,0	80,5	40	40	1514	280	86,1		
NKVE 10/19 S 075 T MCE55/P	60190533	3 x 380-415	7,5	10,0	16,5		195,0	194,5	187,5	182,0	176,0	169,0	160,5	151,0	139,5	93,0	40	40	1646	280	96,0		
NKVE 10/23 S 075 T MCE55/P	60190534	3 x 380-415	7,5	10,0	16,5		235,5	234,0	225,0	218,5	211,0	202,0	192,0	180,5	166,5	110,0	40	40	1766	280	98,5		
NKVE 10/24 S 110 T MCE110/P	60190535	3 x 380-415	11,0	15,0	24,8		248,0	247,0	240,5	234,0	227,0	218,0	208,0	196,0	182,0	122,5	40	40	1891	280	124,5		

# NKVE 1-3-6-10-15-20 S

POMPE PLURISTADIO AD ASSE VERTICALE WITH INVERTER MCE/P



## NKVE 15 S WITH MCE/P

MODEL	CODE	ELECTRICAL DATA				HYDRAULIC DATA										DNA	DNM	H mm	CENTRE DISTANCE mm	WEIGHT Kg	
		VOLTAGE 50 Hz	P2 NOMINAL		In A	Q=m3/h	0	8	10	12	14	16	18	20	22						24
			kW	HP		Q=l/min	0	133	167	200	233	266	300	333	367						400
NKVE 15/02 S 022 M MCE22/P	60185543	1 x 230 V	2,2	3,0	8,1	H (m)	29,0	26,0	25,0	24,0	23,0	21,5	19,5	17,0	14,0	11,0	50	50	878	300	43,0
NKVE 15/03 S 030 T MCE30/P	60190536	3 x 380-415	3,0	4,0	10,9		43,5	39,0	38,0	36,5	34,5	32,5	29,5	26,0	21,5	17,0	50	50	975	300	54,8
NKVE 15/04 S 040 T MCE55/P	60190537	3 x 380-415	4,0	5,5	13,9		58,0	52,5	51,0	49,0	46,5	44,0	40,5	35,5	29,5	23,5	50	50	1023	300	60,0
NKVE 15/05 S 040 T MCE55/P	60190538	3 x 380-415	4,0	5,5	13,9		72,5	65,5	63,5	60,5	57,5	54,5	49,5	43,0	36,0	28,5	50	50	1071	300	61,5
NKVE 15/06 S 055 T MCE55/P	60190539	3 x 380-415	5,5	7,5	19,4		87,5	79,5	77,0	74,0	71,0	67,0	61,5	54,0	46,0	36,5	50	50	1328	300	90,1
NKVE 15/07 S 055 T MCE55/P	60190540	3 x 380-415	5,5	7,5	19,4		102,0	92,0	89,0	86,0	82,0	77,5	70,5	62,0	52,5	41,5	50	50	1376	300	91,6
NKVE 15/08 S 075 T MCE55/P	60190541	3 x 380-415	7,5	10,0	7,1		117,0	106,5	103,0	99,5	95,0	90,0	82,5	72,5	62,0	49,0	50	50	1496	300	101,5
NKVE 15/09 S 075 T MCE55/P	60190542	3 x 380-415	7,5	10,0	7,1		131,5	119,0	115,5	111,0	106,0	100,5	92,0	81,0	69,0	54,5	50	50	1544	300	103,0
NKVE 15/10 S 110 T MCE110/P	60190543	3 x 380-415	11,0	15,0	8,9		147,5	134,5	131,0	126,5	121,0	115,0	106,0	94,0	80,5	65,0	50	50	1687	300	130,0
NKVE 15/12 S 110 T MCE110/P	60190544	3 x 380-415	11,0	15,0	8,9		176,5	161,0	156,5	151,0	144,5	137,5	126,5	112,0	96,0	77,0	50	50	1783	300	133,0
NKVE 15/14 S 110 T MCE110/P	60190545	3 x 380-415	11,0	15,0	12,6		205,5	187,5	182,0	175,5	168,0	159,0	146,0	129,0	110,5	88,0	50	50	1879	300	136,0
NKVE 15/16 S 150 T MCE150/P	60190546	3 x 380-415	15,0	20,0	12,6		235,5	214,0	208,0	200,5	192,0	182,5	167,5	148,0	126,5	101,5	50	50	2026	300	147,5
NKVE 15/17 S 150 T MCE150/P	60190547	3 x 380-415	15,0	20,0	16,5		249,5	227,5	220,5	213,0	203,5	193,0	177,5	156,5	134,0	107,0	50	50	2074	300	149,0

## NKVE 20 S WITH MCE/P

MODEL	CODE	ELECTRICAL DATA				HYDRAULIC DATA										DNA	DNM	H mm	CENTRE DISTANCE mm	WEIGHT Kg	
		VOLTAGE 50 Hz	P2 NOMINAL		In A	Q=m3/h	0	10	12	14	16	18	20	22	24						28
			kW	HP		Q=l/min	0	167	200	233	266	300	333	367	400						467
NKVE 20/02 S 022 M MCE15/P	60190548	1 x 230 V	2,2	3,0	8,1	H (m)	31,0	27,5	27,0	26,0	25,0	24,0	22,5	20,5	18,0	12,0	50	50	878	300	43,0
NKVE 20/03 S 030 T MCE30/P	60190549	3 x 380-415	3,0	4,0	10,9		46,5	41,5	40,5	39,5	38,0	36,5	34,5	31,0	27,5	18,5	50	50	975	300	54,8
NKVE 20/04 S 040 T MCE55/P	60190550	3 x 380-415	4,0	5,5	13,9		62,5	56,0	55,0	53,5	51,5	49,5	46,5	42,5	37,0	25,5	50	50	1023	300	60,0
NKVE 20/05 S 055 T MCE55/P	60189126	3 x 380-415	5,5	7,5	13,9		78,0	70,0	68,5	66,5	64,5	62,0	58,0	53,0	47,0	32,5	50	50	1280	300	89,1
NKVE 20/06 S 075 T MCE55/P	60190551	3 x 380-415	7,5	10,0	19,4		94,5	86,5	84,5	82,5	80,0	77,5	73,5	67,5	60,0	42,5	50	50	1400	300	99,0
NKVE 20/07 S 075 T MCE55/P	60190552	3 x 380-415	7,5	10,0	19,4		110,0	100,5	98,0	95,5	93,0	90,0	85,0	77,5	69,0	48,5	50	50	1448	300	100,0
NKVE 20/08 S 110 T MCE110/P	60190553	3 x 380-415	11,0	15,0	7,1		126,5	117,0	114,0	112,0	109,0	106,0	100,5	92,5	82,5	59,5	50	50	1591	300	127,5
NKVE 20/09 S 110 T MCE110/P	60190554	3 x 380-415	11,0	15,0	7,1		142,5	131,0	128,0	125,5	122,0	118,5	112,5	103,5	92,5	66,5	50	50	1639	300	129,0
NKVE 20/10 S 110 T MCE110/P	60190555	3 x 380-415	11,0	15,0	8,9		158,0	145,5	142,0	139,0	135,0	131,5	124,5	114,0	102,0	73,0	50	50	1687	300	130,0
NKVE 20/12 S 150 T MCE150/P	60190556	3 x 380-415	15,0	20,0	8,9		189,5	174,5	170,5	167,0	162,0	157,5	149,0	137,0	122,5	87,5	50	50	1834	300	142,0
NKVE 20/14 S 150 T MCE150/P	60190557	3 x 380-415	15,0	20,0	12,6		220,5	202,5	198,0	193,5	188,0	182,5	172,5	158,0	141,0	100,5	50	50	1930	300	145,0

## SPECIAL VERSION

### VERSION WITH SPECIAL MECHANICAL SEALS

- (1) Ten. Mecc. SPECIALE tipo E2 = SIC - SIC - EPDM = Carbuoro Silicio/Carbuoro Silicio/AISI 316/EPDM
- (2) Ten. Mecc. SPECIALE tipo V3 = SIC - SIC - VITON = Carbuoro Silicio/Carbuoro Silicio/AISI 316/FKM
- (3) Ten. Mecc. SPECIALE tipo V4 = SIC - CAR - VITON = Carbuoro Silicio/Carbone/AISI 316/FKM
- (4) Ten. Mecc. SPECIALE tipo E5 = WC - WC - EPDM = Carbuoro Tungsteno/Carbuoro Tungsteno/AISI 316/EPDM

# NKVE 32-45-65-95

MULTISTAGE CENTRIFUGAL PUMPS WITH VERTICAL AXIS WITH INVERTER MCE/P



DAB's NKVE 32, 45, 65, 95 pumps are multi-impeller vertical centrifugal pumps with coupling with MCE-P inverter installed as standard; designed for pressurization in civil and commercial environments' they can also be used in agriculture and in watering systems.

For the recirculation of water in heating and air conditioning systems. They are particularly versatile, thanks to the use of the MCE-P inverter, which ensures performance levels capable of automatically adapting to the different needs of the system, keeping a constant pressure. Pressure sensor supplied as standard.

Pump body and upper flange in cathaphoretic paint coated cast iron; impellers, diffusers and pump liner made of AISI 304 stainless steel (AISI 316 stainless steel available on request - X version).

Versatility, thanks to the centre distance between the 2 in-line ports, designed to maximise interchangeability. Starting from 5.5 kW models, the silicon carbide-graphite mechanical seal can be removed without removing the motor. Mechanical seals for aggressive liquids and different connections also available (round, oval, Victaulic, clamp flanges).

All the AISI 316 stainless steel - X version - models are certified for use with drinking water (WRAS and ACS certified).

Pumps coupled by rigid coupling to IE3 high energy efficiency electric motors.

**Operating range**

From 1 m<sup>3</sup>/h to 120 m<sup>3</sup>/h with head up to 320 m

**Type of pumped liquid** Clean, free of solids and abrasive substances, non-viscous, non-aggressive, non-crystallised and chemically neutral

**Maximum % of glycol** 30%

**Min. and max. supported liquid temperature**

From -30 to +120°C (EPDM)

From -15°C to +120°C (Viton/FKM)

**Class of protection** IP 55

**Motor insulation class** F

**Impeller/s material**

AISI 304 stainless steel

AISI 316 for NKV X only on request

**Single phase power input** 1x230 V up to 2,2 kW

**Three phase power input**

380 - 415 V at 50 Hz from 3 kW

**Possible type of installation** Vertical position

**Special versions on request**

Yes, available with different types of mechanical seals for aggressive liquids and connections (round, oval, Victaulic, clamp flanges), **with parts in contact with the liquid in AISI 316 stainless steel (X versions)**, other voltages and frequencies, ATEX version



IE3 ≥ 0,75 kW



PAG. 5

MCE/P  
PAG. 23

ACCESSORIES  
PAG. 207

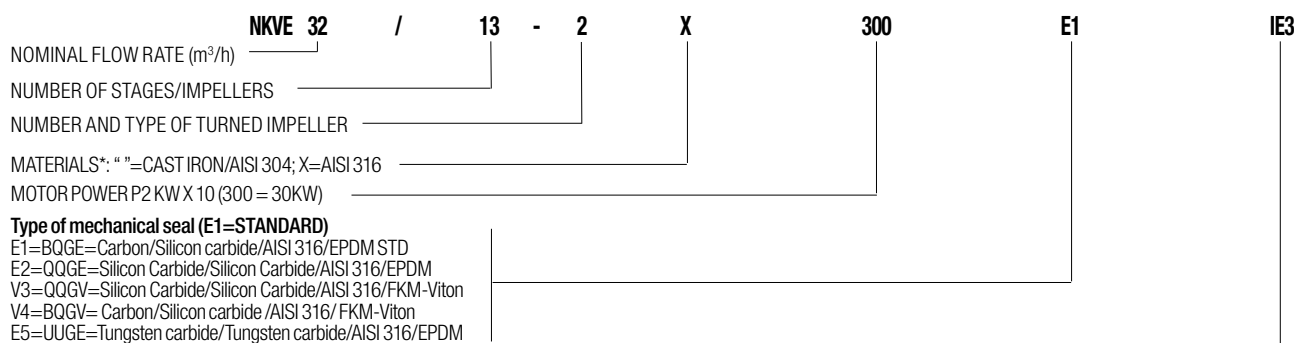

\*MATERIALS:  
"X" version with pump body/impellers/diffusers in AISI 316 stainless steel  
" " standard version with pump body in cast iron and impellers in AISI 304 stainless steel

# NKVE 32-45-65-95

MULTISTAGE CENTRIFUGAL PUMPS WITH VERTICAL AXIS WITH INVERTER MCE/P



## NKVE 32 WITH MCE/P

MODEL	CODE	ELECTRICAL DATA				HYDRAULIC DATA										DNA	DNM	H mm	CENTRE DISTANCE mm	WEIGHT Kg
		VOLTAGE 50 Hz	P2 NOMINAL		In A	Q=m³/h	0	15	18	22	25	30	35	40	45					
			kW	HP		Q=l/min	0	250	300	367	417	500	583	667	750					
NKVE 32/2 T MCE 55/P	60192237	3 x 380-415	5,5	7,5	13,1	H (m)	48,5	43,5	42,5	41,0	39,5	36,5	33,5	29,0	23,5	65	65	1311	320	148
NKVE 32/3-2 T MCE 55/P	60192238	3 x 380-415	5,5	7,5	13,1		60,0	54,5	53,0	50,5	48,0	44,0	38,0	31,5	23,5	65	65	1392	320	152
NKVE 32/3 T MCE 110/P	60167485	3 x 380-415	7,5	10,0	17,6		73,0	65,0	63,5	61,0	59,0	55,0	50,0	43,5	35,5	65	65	1440	320	163
NKVE 32/4 T MCE 110/P	60167486	3 x 380-415	11,0	15,0	25,5		98,0	88,0	86,0	83,0	80,5	75,0	69,0	60,0	49,5	65	65	1657	320	218
NKVE 32/5-2 T MCE 110/P	60167487	3 x 380-415	11,0	15,0	25,5		109,5	99,5	97,0	93,0	89,5	83,0	74,0	63,0	49,5	65	65	1739	320	222
NKVE 32/5 T MCE 150/P	60167488	3 x 380-415	15,0	20,0	34		122,5	109,5	107,0	103,5	100,0	93,5	85,5	75,0	61,5	65	65	1739	320	236
NKVE 32/6 T MCE 150/P	60167489	3 x 380-415	15,0	20,0	34		146,5	131,0	128,0	123,5	119,5	111,5	102,0	89,0	73,0	65	65	1821	320	240
NKVE 32/7-2 T MCE 150/P	60167490	3 x 380-415	15,0	20,0	34		158,0	142,5	139,0	133,5	128,5	119,0	107,0	91,5	72,5	65	65	1903	320	244

## NKVE 45 WITH MCE/P

MODEL	CODE	ELECTRICAL DATA				HYDRAULIC DATA										DNA	DNM	H mm	CENTRE DISTANCE mm	WEIGHT Kg
		VOLTAGE 50 Hz	P2 NOMINAL		In A	Q=m³/h	0	18	25	30	40	54	60	65	70					
			kW	HP		Q=l/min	0	300	417	500	667	900	1000	1083	1166					
NKVE 45/2-2 T MCE 55/P	60192239	3 x 380-415	5,5	7,5	13,1	H (m)	38,5	37,0	35,5	34,5	31,0	23	18,5	14,5	10,0	80	80	1345	365	154
NKVE 45/2 T MCE 110/P	60167491	3 x 380-415	7,5	10,0	17,6		48,5	47,0	45,5	44,0	41,5	34,0	30,5	26,5	23,0	80	80	1393	365	165
NKVE 45/3 T MCE 110/P	60167492	3 x 380-415	11,0	15,0	25,5		73,5	71,0	69,0	67,0	63,0	52,5	47,0	41,0	34,0	80	80	1610	365	220
NKVE 45/4 T MCE 150/P	60167493	3 x 380-415	15,0	20,0	34		97,5	94,5	91,5	89,0	84,0	69,5	62,0	54,5	45,0	80	80	1692	365	238

## NKVE 65 WITH MCE/P

MODEL	CODE	ELECTRICAL DATA				HYDRAULIC DATA										DNA	DNM	H mm	CENTRE DISTANCE mm	WEIGHT Kg
		VOLTAGE 50 Hz	P2 NOMINAL		In A	Q=m³/h	0	30	42	45	54	60	72	78	85					
			kW	HP		Q=l/min	0	500	700	750	900	1000	1200	1300	1417					
NKVE 65/2-2 T MCE 110/P	60192240	3 x 380-415	7,5	10,0	17,6	H (m)	39,0	37,5	35,5	35,0	33,0	31	25,0	22,0	17,5	100	100	1484	365	169,5
NKVE 65/2 T MCE 110/P	60192241	3 x 380-415	11,0	15,0	25,5		56,5	51,0	48,5	48,0	46,0	45,0	41,0	38,5	34,5	100	100	1619	365	220,5
NKVE 65/3-2 T MCE 150/P	60192242	3 x 380-415	15,0	20,0	34		67,5	63,5	60,5	59,5	56,5	54,0	46,5	42,0	35,5	100	100	1711	365	239,0

## NKVE 95 WITH MCE/P

MODEL	CODE	ELECTRICAL DATA				HYDRAULIC DATA										DNA	DNM	H mm	CENTRE DISTANCE mm	WEIGHT Kg
		VOLTAGE 50 Hz	P2 NOMINAL		In A	Q=m³/h	0	45	60	72	78	85	96	108	118					
			kW	HP		Q=l/min	0	750	1000	1200	1300	1417	1600	1800	1967					
NKVE 95/2-2 T MCE 110/P	60192243	3 x 380-415	11,0	15,0	25,5	H (m)	44,5	43,0	41,0	38,5	36,5	34	28,5	21,5	15,0	100	100	1619	380	221
NKVE 95/2 T MCE 150/P	60192244	3 x 380-415	15,0	20,0	34		62,0	55,5	51,5	49,0	47,5	45,0	41,0	35,0	28,5	100	100	1619	380	235

## SPECIAL VERSION VERSION WITH SPECIAL MECHANICAL SEALS

- (1) Ten. Mecc. SPECIALE tipo E2 = SIC - SIC - EPDM = Carbuoro Silicio/Carbuoro Silicio/AISI 316/EPDM
- (2) Ten. Mecc. SPECIALE tipo V3 = SIC - SIC - VITON = Carbuoro Silicio/Carbuoro Silicio/AISI 316/FKM
- (3) Ten. Mecc. SPECIALE tipo V4 = SIC - CAR - VITON = Carbuoro Silicio/Carbone/AISI 316/FKM
- (4) Ten. Mecc. SPECIALE tipo E5 = WC - WC - EPDM = Carbuoro Tungsteno/Carbuoro Tungsteno/AISI 316/EPDM

# ENBLOC ELECTRONIC CENTRIFUGAL PUMPS WITH MCE/C FOR CIRCULATING SYSTEM

PERFORMANCE RANGE

## NKM-GE 4 POLES WITH MCE/C

≈ 1450 1/min

MODEL	P2 NOMINAL		Q (m³/h) (l/min)	H (m)																		
	KW	HP		0	6	12	18	24	30	36	42	48	54	60	66	72	78	84	90	102	114	
NKM-GE 32-125.1/140/A/BAQE/0.25/4 M MCE11/C	0.25	0.33	0	6.2	5.8	4.2																
NKM-GE 32-125/142/A/BAQE/0.37/4 M MCE11/C	0.37	0.5	0	7	6.75	5.85	4.2															
NKM-GE 32-160.1/169/A/BAQE/0.37/4 M MCE11/C	0.37	0.5	0	8.9	8.2	4.6																
NKM-GE 32-160/169/A/BAQE/0.55/4 M MCE11/C	0.55	0.75	0	9.4	9	7.9	5.6															
NKM-GE 32-200.1/200/A/BAQE/0.55/4 M MCE11/C	0.55	0.75	0	12.7	11.2	7.2																
NKM-GE 32-200/219/A/BAQE/1,1/4 M MCE11/C	1.1	1.5	0	16	15.4	14.3	12.2															
NKM-GE 40-125/142/A/BAQE/0.55/4 M MCE11/C	0.55	0.75	0	6.6	6.5	6.2	5.7	4.8														
NKM-GE 40-160/166/A/BAQE/0.75/4 M MCE11/C	0.75	1	0	9.2	9.2	9	8.4	7.4	5.7													
NKM-GE 40-200/219/A/BAQE/1,5/4 M MCE11/C	1.5	2	0	15.6	15.6	15.3	14.7	13.4	11.8	9.8												
NKM-GE 40-250/260/A/BAQE/3/4 T MCE30/C	3	4	0	23.3	23.1	22.8	22.2	20.8	19													
NKM-GE 50-125/141/A/BAQE/0.75/4 M MCE11/C	0.75	1	0	6.5		6.3	6.1	5.8	5.5	5	4.5	3.9										
NKM-GE 50-160/177/A/BAQE/1,5/4 M MCE15/C	1.5	2	0	10.7		10.7	10.7	10.5	10.2	9.8	9.2	8.3										
NKM-GE 50-200/219/A/BAQE/3/4 T MCE30/C	3	4	0	16.8		16.8	16.5	16.1	15.5	14.6	13.6	12.4	10.9									
NKM-GE 50-250/263/A/BAQE/4/4 T MCE30/C	4	5.5	0	23.8		23.8	23.8	23.4	22.7	21.6	20.4	19	17.1									
NKM-GE 65-125/144A/BAQE/1.1/4 M MCE11/C	1.1	1.5	0	6.5		6.4	6.4	6.3	6.2	6	5.75	5.5	5.1	4.65	4.2	3.75						
NKM-GE 65-160/153/A/BAQE/1,1/4 M MCE11/C	1.1	1.5	0	7.4		7.4	7.3	7.15	6.9	6.65	6.25	5.8	5.3	4.4								
NKM-GE 65-160/177/A/BAQE/2,2/4 M MCE22/C	2.2	3	0	10.5				10.4	10.3	10.2	9.9	9.6	9.2	8.75	8.2	7.4	6.6					
NKM-GE 65-200/210/A/BAQE/3/4 T MCE30/C	3	4	0	15.3				15.2	15.2	15.1	14.6	14.1	13.5	12.9	12.2	11.3						
NKM-GE 65-200/219/A/BAQE/4/4 T MCE55/C	4	5.5	0	17				17	16.9	16.8	16.4	16.2	15.8	15.2	14.3	13.8	12.6					
NKM-GE 65-250/263/A/BAQE/5,5/4 T MCE55/C	5.5	7.5	0	24.1				23.8	23.6	23.3	22.8	22.3	21.5	20.8	19.7	18.6	17.3					
NKM-GE 65-315/309/A/BAQE/11/4 T MCE110/C	11	15	0	34.2								33.2	33	32.5	32	31.5	30.7	29.8	29	28	25	21.7

MODEL	P2 NOMINAL		Q (m³/h) (l/min)	H (m)																									
	KW	HP		0	30	36	42	48	54	60	66	72	78	84	90	102	114	120	150	180	210	240	270	300	330	360	390	420	
NKM-GE 80-160/163/A/BAQE/2,2/4 M MCE22/C	2.2	3	0	8.65	8.5	8.45	8.3	8.15	7.9	7.7	7.4	7.2	6.9	6.65	6.3	5.7	4.9	4.6											
NKM-GE 80-160/177/A/BAQE/3/4 T MCE30/C	3	4	0	10.2	10.2	10.1	10	9.9	9.75	9.65	9.5	9.25	9	8.8	8.6	7.9	7.2	6.7											
NKM-GE 80-200/222/A/BAQE/5,5/4 T MCE55/C	5.5	7.5	0	16.6		16.5	16.5	16.4	16.2	16.1	16	15.7	15.4	15	14.3	13.3	12.7												
NKM-GE 80-250/270/A/BAQE/11/4 T MCE110/C	11	15	0	25.6		25.5	25.5	25.4	25.1	25	24.8	24.6	24.2	24	23	21.5	21												
NKM-GE 80-315/305/A/BAQE/15/4 T MCE150/C	15	20	0	32.9				32.7	32.6	32.6	32.5	32.4	32	31.6	30.5	29.5	28.9	24											
NKM-GE 100-200/200/A/BAQE/5.5/4 T MCE55/C	5.5	7.5	0	12.7					12.6	12.6	12.5	12.5	12.4	12.3	12	11.5	11.4	10.1	8.5										
NKM-GE 100-200/214A/BAQE/7.5/4 T MCE110/C	7.5	10	0	15.6					15.4	15.4	15.3	15.2	15.1	15	14.7	14.5	14.3	13.3	11.6	9.8									
NKM-GE 100-250/250/A/BAQE/11/4 T MCE110/C	11	15	0	21.1					21	21	21	21	21	21	20.9	20	19.8	18	16										
NKM-GE 100-250/270/A/BAQE/15/4 T MCE150/C	15	20	0	25.5					25.5	25.5	25.5	25.3	25.1	25.1	25	24.5	24	22.5	20.5	17.5									
NKM-GE 125-250/243/A/BAQE/15/4 T MCE150/C	15	20	0	19.5											19.3	19.3	19.2	19.2	18.7	17.8	16.8	15.5	14.1	12.5	10.9				
NKM-GE 150-200/218/A/BAQE/11/4 T MCE110/C	11	15	0	13.2											13.1	13	13	12.8	12.5	12.1	11.5	11	10.4	9.7	9	8			7



# ENBLOC CENTRIFUGAL PUMPS WITH INVERTER FOR CIRCULATING SYSTEM

PERFORMANCE RANGE

## NKP-GE 2 POLES WITH MCE/C

≈ 2900 1/min

MODEL	P2 NOMINAL		Q (m³/h) (l/min)	0	6	12	18	24	30	36	42	48	54	60	66	72	78	84	90	102	114	120	150	180	210
	kW	HP		0	100	200	300	400	500	600	700	800	900	1000	1100	1200	1300	1400	1500	1700	1900	2000	2500	3000	3500
NKP-GE 32-125.1/115/A/BAQE/1.1/2 M MCE11/C	1.1	1.5		17.2	17	15	12.5																		
NKP-GE 32-125.1/125/A/BAQE/1.5/2 M MCE11/C	1.5	2		21	20.8	19	16.8																		
NKP-GE 32-125.1/140/A/BAQE/2.2/2 M MCE15/C	2.2	3		27	26.9	25.9	23	19.5																	
NKP-GE 32-125/110/A/BAQE/1.1/2 M MCE11/C	1.1	1.5		15.8	15.2	14.5	12.9	9.9																	
NKP-GE 32-125/120/A/BAQE/1.5/2 M MCE11/C	1.5	2		19.3	18.9	18.2	16.8	14.5																	
NKP-GE 32-125/130/A/BAQE/2.2/2 M MCE15/C	2.2	3		23.6	23.1	23	21.6	19.6	16.8																
NKP-GE 32-125/142/A/BAQE/3/2 T MCE30/C	3	4		28.6	28	27.6	26.5	24.6	21.8	17.9															
NKP-GE 32-160.1/166/A/BAQE/3/2 T MCE30/C	3	4		35.3	35	33	28																		
NKP-GE 32-160/151/A/BAQE/3/2 T MCE30/C	3	4		30.5	30	29	27	24	19.5																
NKP-GE 32-160/177/A/BAQE/5,5/2 T MCE55/C	5.5	7.5		43.5	43.2	42.6	41.5	39	36	31.5	25.5														
NKP-GE 32-200.1/205/A/BAQE/5,5/2 T MCE55/C	5.5	7.5		56.6	55.7	52	45.8	36.2																	
NKP-GE 32-200/190/A/BAQE/5,5/2 T MCE55/C	5.5	7.5		46.9	46.5	45	43	40	35	29															
NKP-GE 32-200/210/A/BAQE/7,5/2 T MCE110/C	7.5	10		58.8	58	57	56	53	49	44															
NKP-GE 40-125/107/A/BAQE/1.5/2 M MCE11/C	1.5	2		14.7	14.5	14.3	13.8	13	11.8	10.5	8.6	7													
NKP-GE 40-125/120/A/BAQE/2.2/2 M MCE22/C	2.2	3		19	18.7	18.4	17.8	17	15.9	14.6	13	11													
NKP-GE 40-125/130/A/BAQE/3/2 T MCE30/C	3	4		22.8	22.5	22.3	22	21.2	20.2	19	17.4	15.5	13.5												
NKP-GE 40-125/139/A/BAQE/4/2 T MCE55/C	4	5.5		26.4	26.2	26	25.6	25	24	23	21.5	19.5	17.5	15											
NKP-GE 40-160/158/A/BAQE/5,5/2 T MCE55/C	5.5	7.5		33.7			34	33.4	32.4	31	29.5	27	24												
NKP-GE 40-160/172/A/BAQE/7,5/2 T MCE110/C	7.5	10		40.7			40.2	40.1	39.8	38.5	37.5	35.5	33	30	26.5										
NKP-GE 40-200/210/A/BAQE/11/2 T MCE110/C	11	15		57.1	57	57	56.8	56.5	56	55	53	50	47	43.5	39										
NKP-GE 40-250/230/A/BAQE/15/2 T MCE150/C	15	20		72.5			72.5	72	70	68	66	62.5	60	56	51.5										
NKP-GE 50-125/115/A/BAQE/3/2 T MCE30/C	3	4		17				16.5	16	15.5	15	14.5	13.7	13	12	11	10	9							
NKP-GE 50-125/135/A/BAQE/5,5/2 T MCE55/C	5.5	7.5		24				23.6	23.5	23.2	22.8	22.2	21.5	21	20	19.1	18.5	17.5	16.5	13.4					
NKP-GE 50-125/144/A/BAQE/7,5/2 T MCE110/C	7.5	10		28				27.8	27.5	27.3	27	26.5	25.8	25.3	24.5	23.5	23	21.5	20.5	18	15.5				
NKP-GE 50-160/169/A/BAQE/11/2 T MCE110/C	11	15		39.6					39.5	39.3	39.1	39	38.5	38	37.2	36.5	35	34	32.5						
NKP-GE 50-200/200/A/BAQE/15/2 T MCE150/C	15	20		55.1					54.7	54.6	54	53.5	52	51	49	47.5	45.5	43	41						
NKP-GE 65-125/127/A/BAQE/5,5/2 T MCE55/C	5.5	7.5		19.5						19	18.9	18.7	18.4	18.1	17.5	17.2	16.9	16.5	15.8	14.5	13	12			
NKP-GE 65-125/137/A/BAQE/7,5/2 T MCE110/C	7.5	10		23.5						23.1	23	22.8	22.6	22.5	22	21.6	21.1	20.7	20.2	19	17.5	14.8	12		
NKP-GE 65-160/157/A/BAQE/11/2 T MCE110/C	11	15		32.5								32.3	32	31.9	31.3	30.2	30	29.2	28.7	27	24.8	23.6			
NKP-GE 65-160/173/A/BAQE/15/2 T MCE150/C	15	20		40.1								39.7	39.6	39.5	39.5	39	38.5	38.2	37.5	36	34.5	33.5	26.9		
NKP-GE 80-160/147-127/A/BAQE/11/2 T MCE110/C	11	15		24															22	21.4	20.4	20	17.4	16.8	12
NKP-GE 80-160/153/A/BAQE/15/2 T MCE150/C	15	20		30.5															29	28.4	27.5	27	24.5	21.3	18.3

H (m)

D+CONNECT

COMMAND AND CONTROL SYSTEMS

CIRCULATORS AND IN-LINE PUMPS

MULTISTAGE CENTRIFUGAL AND SELF-PRIMING PUMPS

SWIMMING POOL, POND AND SALT WATER PUMPS

CENTRIFUGAL PUMPS

SUBMERSIBLE PUMPS

SUBMERSIBLE PUMPS AND SUBMERSIBLE MOTORS

PRESSURE UNITS

# NKM-GE / NKP-GE WITH MCE/C

ENBLOC CENTRIFUGAL PUMPS WITH INVERTER



Enbloc electric centrifugal pumps with coupling, designed for a wide range of applications such as:

- Circulation of hot water for heating.
- Circulation of cold water for air conditioning.
- Circulation of cold water for cooling.

Highly versatile pumps thanks to the use of the **MCE/C** inverter, to guarantee performance able to automatically adapt to the various system requirements, while maintaining constant differential pressure. Spiral single-stage body in cast iron according to DIN-EN 733 (ex DIN 24255), cast iron support, flanges according to DIN 2533 and DIN 2532 for DN 200. Cast iron impeller, sealed and dynamically balanced with compensation of the axial thrust via balancing holes, operating (on request) on interchangeable wear rings.

Pump shaft in AISI 304 stainless steel. Seal: standardised mechanical seal according to DIN 24960 in carbon/silicon carbide with O-rings in EPDM. Asynchronous, closed motor cooled by external ventilation, construction design B3/B5, 2-pole for NKPGE and 4-pole for NKM-GE. Rotor mounted on generously sized ball bearings to ensure silent and durable operation.

**Speed of rotation** 1450 - 2900 1/min.

**Operating range**  
from 1 a 450 m³/h head up to 72 metri.

**Liquid temp. range** from -10°C to +140°C.

**Pumped liquid** clean, free from solids or abrasive substances, not viscous, not aggressive, not crystallised and chemically neutral and close to the characteristics of water. **Installation:** normally horizontal or vertical provided the motor is always above the pump.

**Max. ambient temperature** +40°C

**Maximum operating pressure**  
16 bar - 1600 kPa (for DN 200 max. 10 bar).

**Protection rating** IP 55

**Insulation class** F

**Flanging** PN 16 DIN 2533

**Special versions on request**

Pumps for liquids other than water.

Other voltages and/or frequencies.

Inverter modulation with 0-10V signal

IE3 ≥ 0,75 kW



PAG. 5

MCE/P  
PAG. 23

ACCESSORIES  
PAG. 207

## NKM-GE 4 POLES WITH MCE/C - FOR CIRCULATING SYSTEM

MODEL	FLANGE DIMENS. (mm)		VOLTAGE 50/60 Hz - 1x230 ~ V					VOLTAGE 50 Hz - 3x400 ~ V						
	DNA	DNM	CODE	MODEL MCE	P2 NOMINAL		In A	WEIGHT (Kg)	CODE	MODEL MCE	P2 NOMINAL		WEIGHT (Kg)	
					KW	HP					KW	HP		
NKM-GE 32-125.1/140	50	32	60142859	MCE11/C	0,25	0,33	4,7	36						
NKM-GE 32-125/142	50	32	60143037	MCE11/C	0,37	0,50	5,5	39						
NKM-GE 32-160.1/169	50	32	60143038	MCE11/C	0,37	0,50	5,5	38						
NKM-GE 32-160/169	50	32	60142862	MCE11/C	0,55	0,75	6,9	46						
NKM-GE 32-200.1/200	50	32	60142863	MCE11/C	0,55	0,75	6,9	55						
NKM-GE 32-200/219	50	32	60192245	MCE11/C	1,10	1,50	10,4	66	60192104	MCE30/C	1,10	1,50	3,2	68,6
NKM-GE 40-125/142	65	40	60142868	MCE11/C	0,55	0,75	6,9	51						
NKM-GE 40-160/166	65	40	60192246	MCE11/C	0,75	1,00	9,9	54	60192105	MCE30/C	0,75	1,00	2,7	56,6
NKM-GE 40-200/219	65	40	60192247	MCE15/C	1,50	2,00	13,9	70	60192107	MCE30/C	1,50	2,00	4,5	72,6
NKM-GE 40-250/260	65	40							60192248	MCE30/C	3,00	4,00	7,2	98
NKM-GE 50-125/141	65	50	60192249	MCE11/C	0,75	1,00	9,7	55	60192108	MCE30/C	0,75	1,00	t.b.d.	57,6
NKM-GE 50-160/177	65	50	60192250	MCE15/C	1,50	2,00	13,7	64	60192106	MCE30/C	1,50	2,00	4,4	66,6
NKM-GE 50-200/219	65	50							60192251	MCE30/C	3,00	4,00	6,7	90
NKM-GE 50-250/263	65	50							60192252	MCE30/C	4,00	5,50	9,4	105
NKM-GE 65-125/144	80	65	60192253	MCE11/C	1,10	1,50	10,9	65	60192109	MCE30/C	1,10	1,50	t.b.d.	67,6
NKM-GE 65-160/153	80	65	60192254	MCE11/C	1,10	1,50	11,2	67	60192110	MCE30/C	1,10	1,50	3,5	69,6
NKM-GE 65-160/177	80	65	60192255	MCE22/C	2,20	3,00	17,3	80	60192111	MCE30/C	2,20	3,00	5,8	82,6
NKM-GE 65-200/210	80	65							60192256	MCE30/C	3,00	4,00	7,8	97
NKM-GE 65-200/219	80	65							60192257	MCE55/C	4,00	5,50	10,3	105
NKM-GE 65-250/263	80	65							60192258	MCE55/C	5,50	7,50	12,7	168
NKM-GE 65-315/309	80	65							60167494	MCE110/C	11,00	15,00	26,6	263
NKM-GE 80-160/163	100	80							60192262	MCE22/C	2,20	3,00	19,6	87
NKM-GE 80-160/163	100	80							60192112	MCE30/C	2,20	3,00	t.b.d.	89,6
NKM-GE 80-160/177	100	80							60192263	MCE30/C	3,00	4,00	7,6	96
NKM-GE 80-200/222	100	80							60192264	MCE55/C	5,50	7,50	12,9	156
NKM-GE 80-250/270	100	80							60167495	MCE110/C	11,00	15,00	24,4	237
NKM-GE 80-315/305	100	80							60167496	MCE150/C	15,00	20,00	34,7	294
NKM-GE 100-200/200	125	100							60192265	MCE55/C	5,50	7,50	13,7	169
NKM-GE 100-200/214	125	100							60167497	MCE110/C	7,50	10,00	17,7	181
NKM-GE 100-250/250	125	100							60167498	MCE110/C	11,00	15,00	26,0	245
NKM-GE 100-250/270	125	100							60167499	MCE150/C	15,00	20,00	33,2	268
NKM-GE 125-250/243	150	125							60167501	MCE150/C	15,00	20,00	36,7	305
NKM-GE 150-200/218	200	150							60167502	MCE110/C	11,00	15,00	27,8	406

# NKP-GE WITH MCE/C

ENBLOC CENTRIFUGAL PUMPS WITH INVERTER



## NKP-GE 2 POLES WITH MCE/C - FOR CIRCULATING SYSTEM

MODEL	FLANGE DIMENS. (mm)		VOLTAGE 50/60 Hz - 1x230 ~ V						VOLTAGE 50 Hz - 3x400 ~ V					
	DNA	DNM	CODE	MODEL MCE	P2 NOMINAL		In A	WEIGHT (Kg)	CODE	MODEL MCE	P2 NOMINAL		In A	WEIGHT (Kg)
					kW	HP					kW	HP		
NKP-GE 32-125.1/115	50	32	60192113	MCE11/C	1,10	1,5	10,9	51	60192134	MCE30/C	1,10	1,5	t.b.d.	53,6
NKP-GE 32-125.1/125	50	32	60192114	MCE11/C	1,50	2,0	14,7	56	60192135	MCE30/C	1,50	2,0	t.b.d.	58,6
NKP-GE 32-125.1/140	50	32	60192115	MCE15/C	2,20	3,0	19,9	58	60192136	MCE30/C	2,20	3,0	5,6	60,6
NKP-GE 32-125/110	50	32	60192116	MCE11/C	1,10	1,5	13,7	44	60192137	MCE30/C	1,10	1,5	t.b.d.	46,6
NKP-GE 32-125/120	50	32	60192117	MCE11/C	1,50	2,0	17,9	56	60192138	MCE30/C	1,50	2,0	4,1	58,6
NKP-GE 32-125/130	50	32	60192118	MCE15/C	2,20	3,0	24,3	58	60192139	MCE30/C	2,20	3,0	t.b.d.	60,6
NKP-GE 32-125/142	50	32							60192119	MCE30/C	3,00	4,00	7,0	76
NKP-GE 32-160.1/166	50	32							60192120	MCE30/C	3,00	4,00	6,7	70
NKP-GE 32-160.1/177	50	32							60192121	MCE55/C	4,00	5,5	8,5	90,6
NKP-GE 32-160/151	50	32							60192123	MCE30/C	3,00	4,0	7,1	70
NKP-GE 32-160/177	50	32							60192124	MCE55/C	5,50	7,5	12,7	114
NKP-GE 32-200.1/205	50	32							60192125	MCE55/C	5,50	7,5	11,4	114
NKP-GE 32-200/190	50	32							60192126	MCE55/C	5,50	7,5	12,3	126
NKP-GE 32-200/210	50	32							60167568	MCE110/C	7,50	10,0	17,1	135
NKP-GE 40-125/107	65	40	60192127	MCE11/C	1,50	2,0	14,7	61	60192140	MCE30/C	1,50	2,0	t.b.d.	63,6
NKP-GE 40-125/120	65	40	60192128	MCE22/C	2,20	3,0	19,9	74	60192141	MCE30/C	2,20	3,0	t.b.d.	76,6
NKP-GE 40-125/130	65	40							60192129	MCE30/C	3,00	4,0	7,2	85
NKP-GE 40-125/139	65	40							60192130	MCE55/C	4,00	5,5	9,6	107
NKP-GE 40-160/158	65	40							60192122	MCE55/C	5,50	7,5	12,4	119
NKP-GE 40-160/172	65	40							60167569	MCE110/C	7,50	10,0	17,1	127
NKP-GE 40-200/210	65	40							60167570	MCE110/C	11,00	15,0	24,9	207
NKP-GE 40-250/230	65	40							60167571	MCE150/C	15,00	20,0	34,5	220
NKP-GE 50-125/115	65	50							60192131	MCE30/C	3,00	4,0	7,2	87
NKP-GE 50-125/135	65	50							60192132	MCE55/C	5,50	7,5	12,6	124
NKP-GE 50-125/144	65	50							60167572	MCE110/C	7,50	10,0	17,1	133
NKP-GE 50-160/169	65	50							60167573	MCE110/C	11,00	15,0	24,0	132
NKP-GE 50-200/200	65	50							60167574	MCE150/C	15,00	20,0	32,5	216
NKP-GE 65-125/127	80	65							60192133	MCE55/C	5,50	7,5	12,8	122
NKP-GE 65-125/137	80	65							60167575	MCE110/C	7,50	10,0	17,4	131
NKP-GE 65-160/157	80	65							60167576	MCE110/C	11,00	15,0	23,4	202
NKP-GE 65-160/173	80	65							60167577	MCE150/C	15,00	20,0	33,5	212
NKP-GE 80-160/147-127	100	80							60167578	MCE110/C	11,00	15,0	24,1	215
NKP-GE 80-160/153	100	80							60167579	MCE150/C	15,00	20,0	32,6	221

COMMAND AND CONTROL SYSTEMS

CIRCULATORS AND IN-LINE PUMPS

MULTISTAGE CENTRIFUGAL AND SELF-PRIMING PUMPS

SWIMMING POOL, POND AND SALT WATER PUMPS

CENTRIFUGAL PUMPS

SUBMERSIBLE PUMPS

SUBMERSIBLE PUMPS AND SUBMERSIBLE MOTORS

PRESSURE UNITS

# STANDARDISED CENTRIFUGAL PUMPS WITH INVERTER FOR CIRCULATING SYSTEM

PERFORMANCE RANGE

## KDNE 4 POLES WITH MCE/C

≈ 1450 1/min

MODEL	Q (m³/h) (l/min)	0	3	6	12	18	24	30	36	42	48	54	60	66	72	78	84	90	102	114
		0	50	100	200	300	400	500	600	700	800	900	1000	1100	1200	1300	1400	1500	1700	1900
KDNE 32-125.1/140/A/BAQE/1/0,55/4 M MCE11/C		6.6	6.6	6.4	5.1															
KDNE 32-125/142/A/BAQE/1/0,75/4 M MCE11/C		6.9		6.75	6.15	4.5														
KDNE 32-160.1/177/A/BAQE/1/0.75/4 M MCE11/C		9	9.8	9.5	6.6															
KDNE 32-160/177/A/BAQE/1/1,1/4 M MCE11/C		10.5		10.4	9.6	7.8														
KDNE 32-200.1/207/A/BAQE/1/1.1/4 M MCE11/C		13.8	13.8	13	8.9															
KDNE 32-200/200/A/BAQE/1/1,1/4 M MCE11/C		12.6		12.3	11.1	8.7														
KDNE 32-200/219/A/BAQE/1/2,2/4 M MCE22/C		15.7		15.4	14.8	13	9.8													
KDNE 40-125/142/A/BAQE/1/1.1/4 M MCE11/C		6.7		6.6	6.5	6	5.3	4.1												
KDNE 40-160/161/A/BAQE/1/1,1/4 M MCE11/C		8.6		8.5	8.4	8	7.1	5.6												
KDNE 40-160/177/A/BAQE/1/1,5/4 M MCE15/C		10.7		10.7	10.6	10.2	9.5	8.3												
KDNE 40-200/180/A/BAQE/1/1,1/4 M MCE11/C		9.7		9.7	9.4	8.8	7.2													
KDNE 40-200/200/A/BAQE/1/1,5/4 M MCE15/C		12.2		12.1	12	11.7	10.4	8.6												
KDNE 40-200/219/A/BAQE/1/2,2/4 M MCE22/C		15		15	15	14.7	13.8	12.4	10.4											
KDNE 40-250/230/A/BAQE/1/2,2/4 M MCE22/C		17.4			17.2	16.5	15.3	13.7												
KDNE 40-250/240/A/BAQE/1/3/4 T MCE30/C		19.1			19	18.2	17	15.5												
KDNE 40-250/260/A/BAQE/1/4/4 T MCE55/C		22.7			22.6	22.1	21	19.5												
KDNE 50-125/139/A/BAQE/1/1,1/4 M MCE11/C		6.3			6.2	6.1	5.9	5.6	5.2	4.8	4.2									
KDNE 50-125/144/A/BAQE/1/1,5/4 M MCE15/C		6.7			6.7	6.6	6.4	6.2	5.8	5.3	4.8	4.1								
KDNE 50-160/137/A/BAQE/1/1,1/4 M MCE11/C		6			6	5.9	5.6	5.2	4.8											
KDNE 50-160/153/A/BAQE/1/1,5/4 M MCE15/C		7.6			7.6	7.5	7.4	7.2	6.7											
KDNE 50-160/169/A/BAQE/1/2,2/4 M MCE22/C		9.4			9.3	9.2	9.2	9.1	8.8											
KDNE 50-160/177/A/BAQE/1/3/4 T MCE30/C		10.4			10.3	10.3	10.2	10.1	9.95											
KDNE 50-200/170/A/BAQE/1/1,5/4 M MCE15/C		9.5			9.3	9.2	8.8	8	6.85											
KDNE 50-200/190/A/BAQE/1/2,2/4 M MCE22/C		11.8			11.7	11.6	11.4	10.8	10.1	8.9										
KDNE 50-200/210/A/BAQE/1/3/4 T MCE30/C		14.6			14.6	14.5	14.4	13.9	13.2	12.2	11									
KDNE 50-200/219/A/BAQE/1/4/4 T MCE55/C		16			16	16	15.9	15.4	14.2	13.8	12.7	11.4								
KDNE 50-250/220/A/BAQE/1/3/4 T MCE30/C		15.9			15.7	15.6	15.4	14.9	13.8	12.4	10.5									
KDNE 50-250/263/A/BAQE/1/5,5/4 T MCE55/C		23			23	22.9	22.8	22.5	21.7	20.6	19.4	17.5								
KDNE 65-125/130/A/BAQE/1/1,1/4 M MCE11/C		5.1					4.9	4.75	4.6	4.3	4.1	3.8	3.3	2.8						
KDNE 65-125/144/A/BAQE/1/1.5/4 M MCE15/C		6.4					6.35	6.25	6.2	5.9	5.7	5.4	5	4.65	4.2	3.7				
KDNE 65-160/137/A/BAQE/1/1,1/4 M MCE11/C		5.8					5.7	5.4	5.2	4.75	4.3	3.7								
KDNE 65-160/153/A/BAQE/1/1,5/4 M MCE15/C		7.3					7.2	7.2	6.9	6.7	6.3	5.8	5.25							
KDNE 65-160/169/A/BAQE/1/2,2/4 M MCE22/C		9.1					9.1	9	8.9	8.7	8.4	8	7.6	7.1	6.4					
KDNE 65-160/177/A/BAQE/1/3/4 T MCE30/C		10					10	9.9	9.8	9.7	9.45	9.1	8.7	8.2	7.5					
KDNE 65-200/180/A/BAQE/1/2,2/4 M MCE22/C		10.4				10.4	10.4	10.3	10.2	10	9.5	8.8	8.1							
KDNE 65-200/190/A/BAQE/1/3/4 T MCE30/C		12.1				12	12	12	11.9	11.5	11.1	10.5	9.8	8.8						
KDNE65-200/219/A/BAQE/1/5,5/4 T MCE55/C		16.2				16.2	16.2	16.1	16	15.9	15.8	15.4	15	14.4	13.5	12.7				
KDNE 65-250/240/A/BAQE/1/5,5/4 T MCE55/C		19				19	18.9	18.5	18.1	17.5	16.8	16	14.7	13.6						
KDNE 65-250/263/A/BAQE/1/7,5/4 T MCE110/C		23.2				23	23	22.9	22.5	22.2	21.6	20.8	19.8	18.6	17.4	16				
KDNE 65-315/260/A/BAQE/1/7,5/4 T MCE110/C		22.3					22.2	22.1	22	21.5	21	20.5	20	19.2	18.4	17	16	15		
KDNE 65-315/290/A/BAQE/1/11/4 T MCE110/C		28.2					28.2	28.1	28	27.8	27.3	27	26.5	25.5	25	24	23.1	22	19.5	
KDNE 65-315/320/A/BAQE/1/15/4 T MCE150/C		35.7					35.4	35.3	35.2	35.1	35	34.8	34.5	33.8	33.5	32.5	31.5	30.8	28	24.8

H (m)

# STANDARDISED CENTRIFUGAL PUMPS WITH INVERTER FOR CIRCULATING SYSTEM

PERFORMANCE RANGE

## KDNE 4 POLES WITH MCE/C

≈ 1450 1/min

MODEL	Q (m³/h) (l/min)	0	42	48	54	60	66	72	78	84	90	102	114	120	150	180	210	240	270	300	330	360	390	420
		0	700	800	900	1000	1100	1200	1300	1400	1500	1700	1900	2000	2500	3000	3500	4000	4500	5000	5500	6000	6500	7000
KDNE 80-160/153/A/ BAQE/1/2,2/4 M MCE22/C		7.3	7.1	6.9	6.7	6.5	6.3	6	5.75	5.4	5.2	4.55	3.9	3.6										
KDNE 80-160/161/A/ BAQE/1/3/4 T MCE30/C		8.2	8	7.9	7.75	7.5	7.3	7.05	6.8	6.5	6.25	5.6	4.9	4.6										
KDNE 80-160/177/A/ BAQE/1/4/4 T MCE55/C		10	9.9	9.85	9.8	9.7	9.5	9.3	9.1	8.85	8.7	8.1	7.25	6.9										
KDNE 80-200/170/A/ BAQE/1/3/4 T MCE30/C		9.2	9.1	9	8.7	8.5	8.2	7.8	7.5	7.1	6.7	5.6												
KDNE 80-200/200/A/ BAQE/1/5,5/4 T MCE55/C		12.7	12.6	12.6	12.6	12.5	12.4	12.3	12	11.6	11.4	10.5	9.4	8.8										
KDNE 80-200/222/A/ BAQE/1/7,5/4 T MCE110/C		15.9	15.9	15.8	15.7	15.6	15.6	15.5	15.4	15.3	15	14.3	13.4	12.8										
KDNE 80-250/230/A/ BAQE/1/7,5/4 T MCE110/C		17.3	17.3	17.2	17.1	17	16.9	16.8	16.5	16	15.5	14.3	12.4											
KDNE 80-250/260/A/ BAQE/1/11/4 T MCE110/C		22.6	22.5	22.5	22.4	22.3	22.2	22.1	22	21.8	21.4	20.6	19.6	19	15.1									
KDNE 80-250/270/A/ BAQE/1/15/4 T MCE150/C		24.5	24.4	24.4	24.4	24.3	24.2	24.1	24	23.7	23.3	22.4	21.4	20.7	16.3									
KDNE 80-315/290/A/ BAQE/1/15/4 T MCE150/C	H (m)	27.8		27.8	27.8	27.7	27.7	27.6	27.6	27.5	27.4	26.5	25	24.6	19.1									
KDNE 100-200/180/A/ BAQE/1/5,5/4 T MCE55/C		10.1				10.1	10.1	10	9.9	9.7	9.5	9.1	8.5	8.3	7	5.4								
KDNE 100-200/200/A/ BAQE/1/7,5/4 T MCE110/C		12.9				12.8	12.8	12.8	12.7	12.6	12.5	12.2	11.8	11.6	10.4	8.8								
KDNE 100-200/219/A/ BAQE/1/11/4 T MCE110/C		16				15.7	15.7	15.6	15.6	15.5	15.5	15.3	15.1	15	14	12.5	10.8							
KDNE 100-250/240/A/ BAQE/1/11/4 T MCE110/C		18.5				18.3	18.3	18.3	18.2	18.1	18	17.9	17.6	17.4	15.7	13.3								
KDNE 100-250/260/A/ BAQE/1/15/4 T MCE150/C		22.3				22.1	22.1	22.1	22	21.9	21.8	21.7	21.5	21.4	19.8	17.7	15.1							
KDNE 100-315/275/A/ BAQE/1/15/4 T MCE150/C		25.1				25	25	25	24.9	24.8	24.7	24.6	24.4	24	22	19								
KDNE 125-250/230/A/ BAQE/1/15/4 T MCE150/C		16.6										16.6	16.6	16.5	16.3	15.6	14.8	13.8	12.5	12.3	9.5			
KDNE 150-200/218-182/A/ BAQE/1/11/4 T MCE110/C		10.4										10.4	10.4	10.3	10.2	9.9	9.5	9.1	8.6	8.1	7.4	6.6	5.8	
KDNE 150-200/224/A/ BAQE/1/15/4 T MCE150/C		13.8										13.6	13.6	13.5	13.3	13	12.6	12.2	11.7	11.2	10.6	9.9	9.2	8.2

# STANDARDISED CENTRIFUGAL PUMPS WITH INVERTER FOR CIRCULATING SYSTEM

PERFORMANCE RANGE

## KDNE 2 POLES WITH MCE/C

≈ 2900 1/min

MODELLO	Q (m³/h) (l/min)	H (m)																						
		0	6	12	18	24	30	36	42	48	54	60	66	72	78	84	90	102	114	120	150	180	210	240
KDNE 32-125.1/110/A/BAQE/1/1,5/2 M MCE15/C		15.5	15.2	13.9	11.5																			
KDNE 32-125.1/130/A/BAQE/1/2.2/2 M MCE22/C		22.3	22.2	21.3	19																			
KDNE 32-125.1/140/A/BAQE/1/3/2 T MCE30/C		26.5	26.4	25.6	23.4	20.1																		
KDNE 32-125/125/A/BAQE/1/2,2/2 M MCE22/C		20.9		20.1	18.9	16.9	13.5																	
KDNE 32-125/130/A/BAQE/1/3/2 T MCE30/C		22.9		22	21	19.1	16.2																	
KDNE 32-125/142/A/BAQE/1/4/2 T MCE55/C		27.8		27	26.1	24.5	21.7	18																
KDNE 32-160.1/137/A/BAQE/1/1,5/2 M MCE15/C		21.5	21.2	19.3																				
KDNE 32-160.1/145/A/BAQE/1/2,2/2 M MCE22/C		24.7	24.5	22.3	16.5																			
KDNE 32-160.1/153/A/BAQE/1/3/2 T MCE30/C		28.3	28	26	20.5																			
KDNE 32-160.1/177/A/BAQE/1/5,5/2 T MCE55/C		39.5	39.3	38.2	34.5	26																		
KDNE 32-160/145/A/BAQE/1/3/2 T MCE30/C		27		25.8	23.9	21.2	16.9																	
KDNE 32-160/161/A/BAQE/1/5,5/2 T MCE55/C		34		33	31.7	29.1	25.5																	
KDNE 32-160/177/A/BAQE/1/7,5/2 T MCE110/C		41.8		41.5	40.5	38.4	35.3	31.4																
KDNE 32-200.1/170/A/BAQE/1/3/2 T MCE30/C		34.3	34.2	31.9	23.5																			
KDNE 32-200.1/190/A/BAQE/1/5,5/2 T MCE55/C		45.3	44.7	41.5	35.5																			
KDNE 32-200.1/207/A/BAQE/1/7,5/2 T MCE110/C		55.3	55	51.8	46.4	37																		
KDNE 32-200/180/A/BAQE/1/5,5/2 T MCE55/C		39		38.5	36.5	32.5	28																	
KDNE 32-200/200/A/BAQE/1/7,5/2 T MCE110/C		51		49	48	45	40.5	35																
KDNE 32-200/210/A/BAQE/1/11/2 T MCE110/C		57		56	55	52.5	48.5	43	36															
KDNE 32-200/219/A/BAQE/1/15/2 T MCE150/C		63		62	61	59	56.5	52.5	46.5	39.5														
KDNE 40-125/120/A/BAQE/1/3/2 T MCE30/C		18.5		18	17.5	17	16	15	13.5	11.8														
KDNE 40-125/142/A/BAQE/1/5,5/2 T MCE55/C		26.8		26.6	26.4	26	25.3	24.4	23	21.4	19.4	17												
KDNE 40-160/145/A/BAQE/1/5,5/2 T MCE55/C		27.5			27.4	27	25.7	24.2	22.1	19.5														
KDNE 40-160/161/A/BAQE/1/7,5/2 T MCE110/C		34.5			34.5	34.4	33.7	32.3	30.5	28.5	25.8	22.5												
KDNE 40-160/177/A/BAQE/1/11/2 T MCE110/C		42.6			42.5	42.4	42	41.5	40	38.5	35	33	30											
KDNE 40-200/180/A/BAQE/1/7,5/2 T MCE110/C		38.8			38.5	38	37	35	32.5	29	25													
KDNE 40-200/200/A/BAQE/1/11/2 T MCE110/C		48.7			48.4	48.2	47.5	46.5	44	41.5	38.5	34.5												
KDNE 40-200/219/A/BAQE/1/15/2 T MCE150/C		60			59.8	59.7	59.4	59	57	55	52.5	49.5	46	40										
KDNE 40-250/220/A/BAQE/1/15/2 T MCE150/C		63.1			62.8	62.5	61	59	57	55	52	48												
KDNE 50-125/125/A/BAQE/1/5,5/2 T MCE55/C		19.8					19.4	19	18.5	17.9	17.4	16.6	16	15.1	14	13	11.8							
KDNE 50-125/139/A/BAQE/1/7,5/2 T MCE110/C		24.7					24.5	24.3	24	23.5	23	22.4	21.6	20.8	20	19.2	18	15.5						
KDNE 50-125/144/A/BAQE/1/11/2 T MCE110/C		25.9					26.5	26.4	26.1	25.6	25.1	24.5	24	23.2	22.3	21.5	20.5	17.8	15					
KDNE 50-160/145/A/BAQE/1/7,5/2 T MCE110/C		27.2					27	26.9	26.6	26.4	25.5	25	23.8	23	21.5	20.5	19							
KDNE 50-160/161/A/BAQE/1/11/2 T MCE110/C		33.8					33.7	33.7	33.6	33.6	33.3	32.5	31.8	31	29.8	28.5	27.5							
KDNE 50-160/177/A/BAQE/1/15/2 T MCE150/C		41.6					41.5	41.5	41.3	41.2	41	40.6	40.5	39.5	38.8	38	36.7	33.5						
KDNE 50-200/180/A/BAQE/1/11/2 T MCE110/C		42.5					42	41.7	41.4	40.5	39.5	38	36	34	32	29								
KDNE 50-200/190/A/BAQE/1/15/2 T MCE150/C		47.2					46.8	46.6	46	45.7	44.5	43.5	42	40	38	35.5	33							
KDNE 65-125/120-110/A/BAQE/1/5,5/2 T MCE55/C		16								14.4	14	13.6	13.1	12.8	12.2	11.9	11.4	10.2	8.7	8				
KDNE 65-125/130/A/BAQE/1/7,5/2 T MCE110/C		21								19.6	19.5	19.1	18.9	18.5	18	17.5	17	15.7	14.2	13.2				
KDNE 65-125/144/A/BAQE/1/11/2 T MCE110/C		25.6								25.5	25.4	25.2	25	24.6	24.3	24	23.4	22.5	21.1	20.2	16			
KDNE 65-160/137/A/BAQE/1/7,5/2 T MCE110/C		23.1								22.4	22	21.7	21.3	20.5	19.7	19	18	16						
KDNE 65-160/153/A/BAQE/1/11/2 T MCE110/C		29.1								28.8	28.5	28.6	28.5	28	27.5	26.6	26	24	22	21				
KDNE 65-160/169/A/BAQE/1/15/2 T MCE150/C		36.4								36.3	36.2	36.1	36	35.7	35.3	34.7	34	32.7	31	30				
KDNE 65-200/170/A/BAQE/1/15/2 T MCE150/C		37.2								36.8	36.7	36.6	36.5	36	35	34	32.5	30	27	25				
KDNE 80-160/153-136/A/BAQE/1/15/2 T MCE150/C		25.6														24.5	23.8	23	22.5	20.2	17.5	15	11.8	

D+CONNECT

COMMAND AND CONTROL SYSTEMS

CIRCULATORS AND IN-LINE PUMPS

MULTISTAGE CENTRIFUGAL AND SELF-PRIMING PUMPS

SWIMMING POOL, POND AND SALT WATER PUMPS

CENTRIFUGAL PUMPS

SUBMERSIBLE PUMPS

SUBMERSIBLE PUMPS AND SUBMERSIBLE MOTORS

PRESSURE UNITS



# KDNE WITH MCE/C

STANDARDISED CENTRIFUGAL PUMPS ON SKID WITH INVERTER



Standardised centrifugal pumps on skid with elastic coupling, electronics designed for a wide range of applications such as:

- Circulation of hot water for heating.
- Circulation of cold water for air conditioning.
- Circulation of cold water for cooling.

Highly versatile pumps thanks to the use of the DAB MCE/C inverter, to guarantee performance able to automatically adapt to the various system requirements, while maintaining constant differential pressure.

Spiral single-stage body in cast iron according to DIN-EN 733 (ex DIN 24255), cast iron seal cover and motor support, flanges according to DIN 2533 (DIN 2532 for DN 200). Cast iron impeller, sealed and dynamically balanced with axial thrust compensation via balancing holes, operating (on request) on interchangeable wear rings. Pump shaft in stainless steel mounted on two generously sized ball bearings, permanently lubricated and housed in a special chamber inside the support.

Standard seal: standardised mechanical seal according to DIN 24960 in carbon/silicon carbide with O-rings in EPDM. On request, packing seals are available, with hydraulic lubrication ring and gland in two easily removable parts.

Sealed, asynchronous motor cooled by external ventilation; 2-pole or 4-pole. Rotor mounted on generously sized ball bearings to ensure silent and durable operation. Electrical protection: according to standards transposed into the ELECTROMAGNETIC COMPATIBILITY DIRECTIVE EEC 89/336 and subsequent amendments, LOW VOLTAGE DIRECTIVE EEC 73/23 and subsequent amendments and standards CEI 2-3.

**Construction design** B3

**Speed of rotation** 1450 - 2900 1/min.

**Operating range** from 1 a 440 m<sup>3</sup>/h with head up to 70 meters

**Liquid temp. range** from -10°C to +140°C.

**Pumped liquid** clean, free from solid or abrasive substances, not viscous, not aggressive, not crystallised and chemically neutral, characteristics similar to water.

**Max. ambient temperature** +40°C

**Maximum operating pressure** 16 bar - 1600 kPa (per il DN 200 max 10 bar).

**Protection rating** IP 55

**Thermal category** F

**Flanging**

PN 16 DIN 2533

PN 10 DIN 2532 per DN 200

**Installation** fixed horizontally.

**Special versions on request**

IE3 ≥ 0,75 kW

**D CONNECT**

PAG. 5

MCE/P  
PAG. 23

ACCESSORIES  
PAG. 207

## KDNE 4 POLES WITH MCE/C - FOR CIRCULATING SYSTEM

CAST IRON IMPELLER

MODEL	FLANGE DIMENS. (mm)		VOLTAGE 50/60 Hz - 1x230 ~ V				VOLTAGE 50 Hz - 3x400 ~ V					
	DNA	DNM	CODE	MODEL MCE	P2 NOMINAL		WEIGHT (Kg)	CODE	MODEL MCE	P2 NOMINAL		WEIGHT (Kg)
					KW	HP				KW	HP	
KDNE 32-125.1/140	50	32	60142983	MCE11/C	0,55	0,75	87					
KDNE 32-125/142	50	32	60192194	MCE11/C	0,75	1	88	60192167	MCE30/C	0,75	1	90,6
KDNE 32-160.1/177	50	32	60192195	MCE11/C	0,75	1	95	60192168	MCE30/C	0,75	1	97,6
KDNE 32-160/177	50	32	60192196	MCE11/C	1,1	1,5	97	60192169	MCE30/C	1,1	1,5	99,6
KDNE 32-200.1/207	50	32	60192197	MCE11/C	1,1	1,5	110	60192170	MCE30/C	1,1	1,5	112,6
KDNE 32-200/200	50	32	60192198	MCE11/C	1,1	1,5	105	60192171	MCE30/C	1,1	1,5	107,6
KDNE 32-200/219	50	32	60192199	MCE22/C	2,2	3	106	60192172	MCE30/C	2,2	3	108,6
KDNE 40-125/142	65	40	60192200	MCE11/C	1,1	1,5	90	60192173	MCE30/C	1,1	1,5	92,6
KDNE 40-160/161	65	40	60192201	MCE11/C	1,1	1,5	95	60192174	MCE30/C	1,1	1,5	97,6
KDNE 40-160/177	65	40	60192202	MCE15/C	1,5	2	105	60192175	MCE30/C	1,5	2	107,6
KDNE 40-200/180	65	40	60192203	MCE11/C	1,1	1,5	105	60192176	MCE30/C	1,1	1,5	107,6
KDNE 40-200/200	65	40	60192204	MCE15/C	1,5	2	109	60192177	MCE30/C	1,5	2	111,6
KDNE 40-200/219	65	40	60192205	MCE22/C	2,2	3	115	60192178	MCE30/C	2,2	3	117,6
KDNE 40-250/230	65	40	60192206	MCE22/C	2,2	3	133	60192181	MCE30/C	2,2	3	135,6
KDNE 40-250/240	65	40						60192207	MCE30/C	3	4	158
KDNE 40-250/260	65	40						60192208	MCE55/C	4	5,5	209

# KDNE WITH MCE/C

STANDARDISED CENTRIFUGAL PUMPS ON SKID WITH INVERTER



## KDNE 4 POLES WITH MCE/C - FOR CIRCULATING SYSTEM

CAST IRON IMPELLER

MODEL	FLANGE DIMENS. (mm)		VOLTAGE 50/60 Hz - 1x230 ~ V				VOLTAGE 50 Hz - 3x400 ~ V					
	DNA	DNM	CODE	MODEL MCE	P2 NOMINAL		WEIGHT (Kg)	CODE	MODEL MCE	P2 NOMINAL		WEIGHT (Kg)
					kW	HP				kW	HP	
KDNE 50-125/139	65	50	60192209	MCE11/C	1,1	1,5	97	60192182	MCE30/C	1,1	1,5	99,6
KDNE 50-125/144	65	50	60192210	MCE15/C	1,5	2	105	60192179	MCE30/C	1,5	2	107,6
KDNE 50-160/137	65	50	60192211	MCE11/C	1,1	1,5	104	60192180	MCE30/C	1,1	1,5	106,6
KDNE 50-160/153	65	50	60192212	MCE15/C	1,5	2	107	60192183	MCE30/C	1,5	2	109,6
KDNE 50-160/169	65	50	60192213	MCE22/C	2,2	3	111	60192184	MCE30/C	2,2	3	113,6
KDNE 50-160/177	65	50						60192214	MCE30/C	3	4	119
KDNE 50-200/170	65	50	60192215	MCE15/C	1,5	2	118	60192185	MCE30/C	1,5	2	120,6
KDNE 50-200/190	65	50	60192216	MCE22/C	2,2	3	127	60192186	MCE30/C	2,2	3	129,6
KDNE 50-200/210	65	50						60192217	MCE30/C	3	4	131
KDNE 50-200/219	65	50						60192218	MCE55/C	4	5,5	131
KDNE 50-250/220	65	50						60192219	MCE30/C	3	4	147
KDNE 50-250/263	65	50						60192220	MCE55/C	5,5	7,5	182
KDNE 65-125/130	80	65	60192221	MCE11/C	1,1	1,5	104	60192187	MCE30/C	1,1	1,5	106,6
KDNE 65-125/144	80	65	60192222	MCE15/C	1,5	2	107	60192188	MCE30/C	1,5	2	109,6
KDNE 65-160/137	80	65	60192223	MCE11/C	1,1	1,5	107	60192189	MCE30/C	1,1	1,5	109,6
KDNE 65-160/153	80	65	60192224	MCE15/C	1,5	2	118	60192190	MCE30/C	1,5	2	120,6
KDNE 65-160/169	80	65	60192225	MCE22/C	2,2	3	118	60192191	MCE30/C	2,2	3	120,6
KDNE 65-160/177	80	65						60192226	MCE30/C	3	4	157
KDNE 65-200/180	80	65	60192227	MCE22/C	2,2	3	151	60192192	MCE30/C	2,2	3	153,6
KDNE 65-200/190	80	65						60192228	MCE30/C	3	4	159
KDNE 65-200/219	80	65						60192229	MCE55/C	5,5	7,5	209
KDNE 65-250/240	80	65						60192230	MCE55/C	5,5	7,5	210
KDNE 65-250/263	80	65						60167580	MCE110/C	7,5	10	270
KDNE 65-315/260	80	65						60167581	MCE110/C	7,5	10	305
KDNE 65-315/290	80	65						60167582	MCE110/C	11	15	310
KDNE 65-315/320	80	65						60167583	MCE150/C	15	20	310
KDNE 80-160/153	100	80	60192231	MCE22/C	2,2	3	143	60192193	MCE30/C	2,2	3	145,6
KDNE 80-160/161	100	80						60192232	MCE30/C	3	4	147
KDNE 80-160/177	100	80						60192233	MCE55/C	4	5,5	147
KDNE 80-200/170	100	80						60192234	MCE30/C	3	4	177
KDNE 80-200/200	100	80						60192235	MCE55/C	5,5	7,5	197
KDNE 80-200/222	100	80						60167584	MCE110/C	7,5	10	201
KDNE 80-250/230	100	80						60167585	MCE110/C	7,5	10	232
KDNE 80-250/260	100	80						60167586	MCE110/C	11	15	271
KDNE 80-250/270	100	80						60167587	MCE150/C	15	20	290
KDNE 80-315/290	100	80						60167588	MCE150/C	15	20	403
KDNE 100-200/180	125	100						60192236	MCE55/C	5,5	7,5	223
KDNE 100-200/200	125	100						60167589	MCE110/C	7,5	10	222
KDNE 100-200/219	125	100						60167590	MCE110/C	11	15	320
KDNE 100-250/240	125	100						60167591	MCE110/C	11	15	305
KDNE 100-250/260	125	100						60167592	MCE150/C	15	20	313
KDNE 100-315/275	125	100						60167593	MCE150/C	15	20	313
KDNE 125-250/230	150	125						60167594	MCE150/C	15	20	429
KDNE 150-200/218-182	200	150						60167595	MCE110/C	11	15	467
KDNE 150-200/224	200	150						60167596	MCE150/C	15	20	467

COMMAND AND CONTROL SYSTEMS

CIRCULATORS AND IN-LINE PUMPS

MULTISTAGE CENTRIFUGAL AND SELF-PRIMING PUMPS

SWIMMING POOL, POND AND SALT WATER PUMPS

CENTRIFUGAL PUMPS

SUBMERSIBLE PUMPS

SUBMERSIBLE PUMPS AND SUBMERSIBLE MOTORS

PRESSURE UNITS



# KDNE WITH MCE/C

STANDARDISED CENTRIFUGAL PUMPS ON SKID WITH INVERTER



## KDNE 2 POLES WITH MCE/C - FOR CIRCULATING SYSTEM

CAST IRON IMPELLER

MODEL	FLANGE DIMENS. (mm)		VOLTAGE 50/60 Hz - 1x230 ~ V				VOLTAGE 50 Hz - 3x400 ~ V					
	DNA	DNM	CODE	MODEL MCE	P2 NOMINAL		WEIGHT (Kg)	CODE	MODEL MCE	P2 NOMINAL		WEIGHT (Kg)
					KW	HP				KW	HP	
KDNE 32-125.1/110	50	32	60192147	MCE15/C	1,5	2	97	60192142	MCE30/C	1,5	2	99,6
KDNE 32-125.1/130	50	32	60192148	MCE22/C	2,2	3	104	60192143	MCE30/C	2,2	3	106,6
KDNE 32-125.1/140	50	32						60192149	MCE30/C	3	4	111
KDNE 32-125/125	50	32	60192150	MCE22/C	2,2	3	97	60192144	MCE30/C	2,2	3	99,6
KDNE 32-125/130	50	32						60192151	MCE30/C	3	4	105
KDNE 32-125/142	50	32						60192152	MCE55/C	4	5,5	126
KDNE 32-160.1/137	50	32	60192153	MCE15/C	1,5	2	98	60192145	MCE30/C	1,5	2	100,6
KDNE 32-160.1/145	50	32	60192154	MCE22/C	2,2	3	106	60192146	MCE30/C	2,2	3	108,6
KDNE 32-160.1/153	50	32						60192155	MCE30/C	3	4	111
KDNE 32-160.1/177	50	32						60192156	MCE55/C	5,5	7,5	145
KDNE 32-160/145	50	32						60192157	MCE30/C	3	4	111
KDNE 32-160/161	50	32						60192158	MCE55/C	5,5	7,5	145
KDNE 32-160/177	50	32						60167597	MCE110/C	7,5	10	152
KDNE 32-200.1/170	50	32						60192160	MCE30/C	3	4	149
KDNE 32-200.1/190	50	32						60192159	MCE55/C	5,5	7,5	152
KDNE 32-200.1/207	50	32						60167598	MCE110/C	7,5	10	179
KDNE 32-200/180	50	32						60192161	MCE55/C	5,5	7,5	152
KDNE 32-200/200	50	32						60167599	MCE110/C	7,5	10	190
KDNE 32-200/210	50	32						60167600	MCE110/C	11	15	250
KDNE 32-200/219	50	32						60167601	MCE150/C	15	20	261
KDNE 40-125/120	65	40						60192162	MCE30/C	3	4	100
KDNE 40-125/142	65	40						60192163	MCE55/C	5,5	7,5	143
KDNE 40-160/145	65	40						60192164	MCE55/C	5,5	7,5	169
KDNE 40-160/161	65	40						60167602	MCE110/C	7,5	10	178
KDNE 40-160/177	65	40						60167603	MCE110/C	11	15	186
KDNE 40-200/180	65	40						60167604	MCE110/C	7,5	10	160
KDNE 40-200/200	65	40						60167605	MCE110/C	11	15	234
KDNE 40-200/219	65	40						60167606	MCE150/C	15	20	244
KDNE 40-250/220	65	40						60167607	MCE150/C	15	20	291
KDNE 50-125/125	65	40						60192165	MCE55/C	5,5	7,5	152
KDNE 50-125/139	65	40						60167608	MCE110/C	7,5	10	156
KDNE 50-125/144	65	50						60167609	MCE110/C	11	15	156
KDNE 50-160/145	65	50						60167610	MCE110/C	7,5	10	190
KDNE 50-160/161	65	50						60167611	MCE110/C	11	15	201
KDNE 50-160/177	65	50						60167612	MCE150/C	15	20	213
KDNE 50-200/180	65	50						60167613	MCE110/C	11	15	199
KDNE 50-200/190	65	50						60167614	MCE150/C	15	20	293
KDNE 50-200/170	65	50						60192166	MCE55/C	5,5	7,5	152
KDNE 65-125/120-110	80	65						60167615	MCE110/C	7,5	10	159
KDNE 65-125/130	80	65						60167616	MCE110/C	11	15	188
KDNE 65-125/144	80	65						60167617	MCE110/C	7,5	10	186
KDNE 65-160/137	80	65						60167618	MCE110/C	11	15	196
KDNE 65-160/153	80	65						60167619	MCE150/C	15	20	233
KDNE 65-160/169	80	65						60167620	MCE150/C	15	20	292
KDNE 65-200/170	80	65						60167621	MCE150/C	15	20	311
KDNE 80-160/153-136	80	65										

COMMAND AND CONTROL SYSTEMS

CIRCULATORS AND IN-LINE PUMPS

MULTISTAGE CENTRIFUGAL AND SELF-PRIMING PUMPS

SWIMMING POOL, POND AND SALT WATER PUMPS

CENTRIFUGAL PUMPS

SUBMERSIBLE PUMPS

SUBMERSIBLE PUMPS AND SUBMERSIBLE MOTORS

PRESSURE UNITS



Axial suction AISI 304 stainless steel single impeller centrifugal pump for pressurization in civil and industrial environments (cold and hot liquids, and coolants), of thermal waters, and for industrial washing systems.

The standard construction materials ensure higher resistance to oxidation (rust) and therefore to erosion, and most of all operation at high temperatures (90°C).

Other possibilities of use are: in propylene glycol (V version) and ethylene glycol (E version) chiller systems; in industrial washing systems using cold water, hot water, and coolants; with moderately oily or aggressive liquids (V and VS version)

#### Operating range

up to 10 m<sup>3</sup>/h with head up to 32 metres.

**Pumped liquid** clean, free of solids and abrasives, non-viscous, non-crystallised and chemically neutral, with properties similar to water.

**Liquid temperature range** from -10 °C to +90 °C

**Maximum ambient temperature** +40 °C

**Maximum operating pressure** 8 bar (800 kPa)

**Protection class** IP 55

**Insulation class** F

**Standard voltage** 220-230 V/50 Hz single-phase, 230-400 V/50 Hz three-phase

**Installation** fixed horizontal or vertical position, provided that the motor is always above the pump.

#### Special executions on request

special mechanical seals:

**V version** Alox Ceramic/Carbon/FKM: for oily liquids (up to 110°C) and propylene glycol.

**VS version** SiC/SiC/FKM: for oily liquids (up to 110°C) and abrasive particles.

**Version E** SiC/Carbon/EPDM: water up to 120°C and ethylene glycol.

IE3 ≥ 0,75 kW

IE2 ≥ 0,75 kW

EXTRA EU

MODEL	CODE	ELECTRICAL DATA						HYDRAULIC DATA													DNA	DNM	KG	Q.TY x PALLET					
		VOLTAGE 50 Hz	P1 MAX kW	P2 NOMINAL kW	HP	In A	MOTOR TYPE	Q=m <sup>3</sup> /h	0	1,2	3	4,8	5,4	6,6	7,8	8,4	9,6	10,8	11,7	Q=l/min					0	20	50	80	90
KI 30/90 M	60173605	1x220-230 V	1,4	0,75	1	6,5	-	H (m)	31,4	30,1	27,8	25,1	24,0	21,7	19,0	17,5					1"1/4 G	1" G	13,4	27					
KI 30/90 T	60184269	3x230/400 V	1,25	0,75	1	4 / 2,3	IE3		31,4	30,1	27,8	25,1	24,0	21,7	19,0	17,5					1"1/4 G	1" G	12,2	27					
KI 30/120 M	60173606	1x220-230 V	1,55	1	1,36	7	-		32,0	30,7	28,9	27,0	26,3	24,8	22,8	21,6	19,2	16,5			1"1/4 G	1" G	13,4	27					
KI 30/120 T	60179404	3x230/400 V	1,4	1	1,36	4,7 / 2,7	IE3		32,0	30,7	28,9	27,0	26,3	24,8	22,8	21,6	19,2	16,5			1"1/4 G	1" G	12,3	27					
KI 40/120 M*	60173608	1x220-230 V	2,2	1,5	2	9,7	-		40,3	39,1	37,2	35,2	34,5	33,0	31,3	30,4	28,5	26,4	23,0			1"1/4 G	1" G	19,6	18				
KI 40/120 T*	60184272	3x230/400 V	2,1	1,5	2	7 / 4,1	IE3		40,3	39,1	37,2	35,2	34,5	33,0	31,3	30,4	28,5	26,4	23,0			1"1/4 G	1" G	19,3	27				
KI 30/90 T	60184268	3x230/400 V	1,29	0,75	1	4,5 / 2,6	IE2	H (m)	31,4	30,1	27,8	25,1	24,0	21,7	19,0	17,5					1"1/4 G	1" G	12,2	27					
KI 30/120 T	60173607	3x230/400 V	1,45	1	1,36	5 / 2,9			32,0	30,7	28,9	27,0	26,3	24,8	22,8	21,6	19,2	16,5			1"1/4 G	1" G	13,8	27					
KI 40/120 T*	60184271	3x230/400 V	2,2	1,5	2	7,5 / 4,3			40,3	39,1	37,2	35,2	34,5	33,0	31,3	30,4	28,5	26,4	23,0			1"1/4 G	1" G	19,3	27				

\* Not MEI comply, only for EXTRA EU Market

## SPECIAL SEALS

E.g.: KI 30/90 M with elastomers and FKM seal: KI 30/90 M -V

ADDITIONAL DESCRIPTION	MECHANICAL SEAL MATERIAL	ELASTOMERS
-V	Carbon/Alox Ceramic/FKM	FKM
-VS	SiC/SiC/FKM	FKM
-E	Carbon/SiC/EPDM	EPDM

# K SINGLE IMPELLER

## SINGLE IMPELLER CENTRIFUGAL PUMPS



Single impeller centrifugal pump suitable for domestic, civil, industrial and agricultural installations and for decanting, mixing and irrigating uses. Cast iron pump body and motor support. Technopolymer impeller. Stainless steel driving shaft. Carbon/ceramic mechanical seal. Asynchronous, closed motor, cooled by external ventilation. Built-in thermal and current overload protection and a capacitor permanently on in the single-phase version. For the protection of the three-phase motor it is advisable to use a suitable overload protection complying with the regulations in force.



K 35/1200 T

**Operating range** from 1,8 to 96 m<sup>3</sup>/h with head up to 62 metres.

**Pumped liquid characteristics** clean, free from solids or abrasive substances, not viscous, not aggressive, not crystallised, chemically neutral and close to the characteristics of water.

### Liquid temperature range

from -10°C to +50°C: for K 20/41, K 30/70, K 30/100, K 36/100, K 12/200, K 36/200, K 40/200.

from -15°C to +110°C: for the other pups.

### Maximum operating range

K 20/41, K 30/70, K 30/100, K 36/100, K 12/200, K 14/400: **6 bar (600 kPa)**

K 36/200, K 40/200, K 55/200, K 11/500, K 18/500, K 28/500: **8 bar (800 kPa)**

K 40/400, K 50/400, K 30/800, K 40/800, K 50/800,

K 20/1200, K 25/1200, K 35/1200: **10 bar (1000 kPa)**

**Maximum ambient temperature** +40°C.

**Protection level** IP 44.

**Terminal board protection level** IP 55.

**Insulation class** F.

IE3 ≥ 0,75 kW

IE2 ≥ 0,75 kW

EXTRA EU

## K - SINGLE IMPELLER CENTRIFUGAL

MODEL	CODE	ELECTRICAL DATA						HYDRAULIC DATA																	Q.TY x PALLET	
		VOLTAGE 50 Hz	P1 MAX kW	P2 NOMINAL		In A	MOTOR TYPE	Q=m <sup>3</sup> /h	0	1,8	2,4	3,6	4,8	6	7,2	9	9,6	10,8	12	15	18	DNA	DNM	KG		
				kW	HP			Q=l/min	0	30	40	60	80	100	120	150	160	180	200	250	300					
K 20/41 M	102110004	1 x 220 - 240 V ~	0,65	0,37	0,5	3	-																1" G	1" G	10	39
K 20/41 T	102110014	3 x 230 - 400 V ~	0,64	0,37	0,5	2,3-1,3	-																1" G	1" G	9,3	39
K 30/70 M	102110024	1 x 220 - 240 V ~	1,3	0,75	1	6	-		31,8	29,5	28,9	27	24,2	19,8	13,5								1" G	1" G	13,9	30
K 30/70 T	60179407	3 x 230 - 400 V ~	1,2	0,75	1	4-2,3	IE3		31,8	29,5	28,9	27	24,2	19,8	13,5								1" G	1" G	13,7	30
K 30/100 M	102110042	1 x 220 - 240 V ~	1,6	1,1	1,5	7,1	-		29,2		29	28,8	28	26,8	25,3	22,5	21,5	18,5					1½" G	1" G	18,5	21
K 30/100 T	60179858	3 x 230 - 400 V ~	1,6	1,1	1,5	5,4-3,1	IE3		29,2		29	28,8	28	26,8	25,3	22,5	21,5	18,5					1½" G	1" G	18,2	21
K 36/100 M	102110162	1 x 220 - 240 V ~	2,1	1,85	2,5	8,8	-		34,9		34,8	34,6	34	33	32	29,8	29	26,5					1½" G	1" G	23,3	18
K 36/100 T	60179861	3 x 230 - 400 V ~	1,9	1,85	2,5	6-3,5	IE3		34,9		34,8	34,6	34	33	32	29,8	29	26,5					1½" G	1" G	19,7	21
K 12/200 M	60168883	1 x 220 - 240 V ~	1,1	0,75	1	5,2	-		18,4		17,2	16,5	16	15,3	14,7	13,5	13,1	12,3	11,4	8,9	5,5		1½" G	1½" G	13,7	30
K 12/200 T	60179406	3 x 230 - 400 V ~	0,97	0,75	1	3,5-2	IE3		18,4		17,2	16,5	16	15,3	14,7	13,5	13,1	12,3	11,4	8,9	5,5		1½" G	1½" G	13,8	30
K 36/200 M	60152451	1 x 230	3	2,2	3	13,5	-		36	35,5	35	34	33,3	32,5	31,5	28	23,5						2" G	1¼" G	33,1	18
K 36/200 T	60179375	3 x 230 - 400 V ~	3,1	2,2	3	9,7-5,6	IE3		36,6				36	35,5	35	34	33,3	32,5	31,5	28	23,5		2" G	1¼" G	21	18
K 40/200 M	60152452	1 x 230	3,9	3	4	17,5	-		41,3				41	40,5	40	39	38,8	38	37	33,5	29		2" G	1¼" G	34,9	18
K 40/200 T	60179374	3 x 230 - 400 V ~	3,6	3	4	10,9-6,3	IE3		41,3				41	40,5	40	39	38,8	38	37	33,5	29		2" G	1¼" G	19	18
K 55/200 M	60152453	1 x 230	5	4	5,5	21,8	-		54				54	53,9	53,2	53	52	51,5	48,5	45			2" G	1¼" G	39	18
K 55/200 T	60179853	3 x 230 - 400 V ~	5,1	3,7	5	15,9-9,2	IE3		54				54	53,9	53,2	53	52	51,5	48,5	45			2" G	1¼" G	39	18

# K SINGLE IMPELLER

## SINGLE IMPELLER CENTRIFUGAL PUMPS



IE3 ≥ 0,75 kW

IE2 ≥ 0,75 kW

EXTRA EU

MODEL	CODE	ELECTRICAL DATA						HYDRAULIC DATA														DNA	DNM	KG	Q.TY x PALLET
		VOLTAGE 50 Hz	P1 MAX kW	P2 NOMINAL		In A	MOTOR TYPE	Q=m³/h	0	12	15	18	24	30	36	42	60	72	84	96					
				kW	HP			Q=l/min	0	200	250	300	400	500	600	700	1000	1200	1400	1600					
K 14/400 M	102130402	1 x 220 - 240 V ~	2,1	1,85	2,5	9,5	-	H (m)	19	18,8	18,5	18	16,3	13,8	10						2" G	2" G	24,5	18	
K 14/400 T	60179855	3 x 230 - 400 V ~	1,9	1,85	2,5	6-3,5	IE3		19	18,8	18,5	18	16,3	13,8	10						2" G	2" G	22	21	
K 11/500 M	60168869	1 x 230	2,8	2,2	3	12,5	-		24,5	22,5	21,5	20	16,5	11,5	6,5						2½" G	2" G	34,2	18	
K 11/500 T	60179379	3 x 230 - 400 V ~	2,9	2,2	3	9,3-5,4	IE3		24,5	22,5	21,5	20	16,5	11,5	6,5						2½" G	2" G	21	18	
K 18/500 M	60168870	1 x 230	3,9	3	4	18	-		31	30,7	30,4	30	28	24	17,9									18	
K 18/500 T	60179380	3 x 230 - 400 V ~	3,7	3	4	11,4-6,6	IE3		31	30,7	30,4	30	28	24	17,9						2½" G	2" G	19	18	
K 28/500 M	60168871	1 x 230	4,7	4	5,5	21,4	-		35	34,5	34	32,8	29,3	25,2	20						2½" G	2" G	42	18	
K 28/500 T	60179882	3 x 230 - 400 V ~	4,6	3,7	5	14,2-8,2	IE3		35	34,5	34	32,8	29,3	25,2	20						2½" G	2" G	40,6	18	
K 40/400 T	60180172	3 x 400 V ~ <sup>1</sup>	6,7	5,5	7,5	11,7			50,5	49	48	45	37	24							65	50	79	6	
K 50/400 T	60167622	3 x 400 V ~ <sup>1</sup>	8,5	7,5	10	14,5			62	61	60	59	54,5	46							65	50	78,8	6	
K 30/800 T	60167623	3 x 400 V ~ <sup>1</sup>	8,2	7,5	10	14,4			44				42	40	38	35	21,5				80	65	90,2	6	
K 40/800 T	60167624	3 x 400 V ~ <sup>1</sup>	10,2	9,2	12,5	17,1			51,5				50	48	47	43,5	32,5	21			80	65	95	6	
K 50/800 T	60167625	3 x 400 V ~ <sup>1</sup>	12,7	11	15	21			58				56,5	55	53,5	51	41	31			80	65	104,3	6	
K 20/1200 T	60167626	3 x 400 V ~ <sup>1</sup>	8,3	7,5	10	14,3			37,5				36,5	36	35	34	30	26	21	15	80	65	88	6	
K 25/1200 T	60167627	3 x 400 V ~ <sup>1</sup>	9,4	9,2	12,5	16,2			40,7				39	38,5	38	37	33,5	30	25	18	80	65	94	6	
K 35/1200 T	60167628	3 x 400 V ~ <sup>1</sup>	11,8	11	15	20			45						43	42,5	38,5	35	31,5	27	80	65	100	6	

MODEL	CODE	ELECTRICAL DATA						HYDRAULIC DATA														DNA	DNM	KG	Q.TY x PALLET
		VOLTAGE 50 Hz	P1 MAX kW	P2 NOMINAL		In A	MOTOR TYPE	Q=m³/h	0	1,8	2,4	3,6	4,8	6	7,2	9	9,6	10,8	12	15	18				
				kW	HP			Q=l/min	0	30	40	60	80	100	120	150	160	180	200	250	300				
K 30/70 T	60145269	3 x 230 - 1 400 V ~	1,2	0,75	1	4,3/2,5	H (m)	31,8	29,5	28,9	27	24,2	19,8	13,5								1" G	1" G	13,7	30
K 30/100 T	60145771	3 x 230 - 400 V ~	1,63	1,1	1,5	6,9/3,9		29,2		29	28,8	28	26,8	25,3	22,5	21,5	18,5					1½" G	1" G	18,2	21
K 36/100 T	60145837	3 x 230 - 400 V ~	2	1,85	2,5	6,9/4		34,9		34,8	34,6	34	33	32	29,8	29	26,5					1½" G	1" G	19,7	21
K 12/200 T	60168884	3 x 230 - 400 V ~	1,15	0,75	1	3,6/2,1		18,4		17,2	16,5	16	15,3	14,7	13,5	13,1	12,3	11,4	8,9	5,5		1½" G	1½" G	13,8	30
K 36/200 T	60146040	3 x 230 - 400 V ~	3	2,2	3	9,5/2		36,6				36	35,5	35	34	33,3	32,5	31,5	28	23,5		2" G	1¼" G	33,1	18
K 40/200 T	60146050	3 x 230 - 400 V ~	3,5	3	4	11,1/6,4		41,3				41	40,5	40	39	38,8	38	37	33,5	29		2" G	1¼" G	34,9	18
K 55/200 T	60146064	3 x 230 - 400 V ~	5,1	4	5,5	16,3/9,4		54					54	53,9	53,2	53	52	51,5	48,5	45		2" G	1¼" G	39	18

MODEL	CODE	ELECTRICAL DATA						HYDRAULIC DATA														DNA	DNM	KG	Q.TY x PALLET
		VOLTAGE 50 Hz	P1 MAX kW	P2 NOMINAL		In A	MOTOR TYPE	Q=m³/h	0	12	15	18	24	30	36										
				kW	HP			Q=l/min	0	200	250	300	400	500	600										
K 14/400 T	60145845	3 x 230 - 400 V ~	2,1	1,85	2,5	7/4	H (m)	19	18,8	18,5	18	16,3	13,8	10	2" G	2" G	22	21							
K 11/500 T	60168866	3 x 230 - 400 V ~	2,6	2,2	3	7,6/4,4		24,5	22,5	21,5	20	16,5	11,5	6,5	2½" G	2" G	34,2	18							
K 18/500 T	60168867	3 x 230 - 400 V ~	3,4	3	4	10,2/5,9		29,6	29,2	28,5	27,4	24	19,5	13,8	2½" G	2" G	36,6	18							
K 28/500 T	60168868	3 x 230 - 400 V ~	4,5	4	5,5	14,7/8,5		35	34,5	34	32,8	29,3	25,2	20	2½" G	2" G	40,6	18							

<sup>1</sup> Star (A) starting is possible

## K - SINGLE IMPELLER CENTRIFUGAL - SINGLE-PHASE

MODEL	CODE	ELECTRICAL DATA						HYDRAULIC DATA														DNA	DNM	WEIGHT Kg	Q.TY x PALLET
		VOLTAGE 50 Hz	P1 MAX kW	P2 NOMINAL		In A	MOTOR TYPE	Q=m³/h	0	4,8	6	7,2	9	9,6	10,8	12	15	18	24	30	36				
				kW	HP			Q=l/min	0	80	100	120	150	160	180	200	250	300	400	500	600				
K 36/200 M	60152451	1 x 230	3,0	2,2	3	13,5	H (m)	36,6	36	35,5	35	34	33,3	32,5	31,5	28	23,5					2" G	1¼" G	33,1	18
K 40/200 M	60152452	1 x 230	3,6	3	4	16,0		41,3	41	40,5	40	39	38,8	38	37	33,5	29					2" G	1¼" G	34,9	18
K 55/200 M	60152453	1 x 230	5,0	4	5,5	21,8		54		54	53,9	53,2	53	52	51,5	48,5	45					2" G	1¼" G	39	18
K 11/500 M	60168869	1 x 230	2,5	2,2	3	11,2		24,5							22,5	21,5	20	16,5	11,5	6,5		2½" G	2" G	34,2	18

# K TWIN IMPELLERS

TWIN IMPELLERS CENTRIFUGAL PUMPS



K 35/40 M



K 70/300 T

Twin impeller centrifugal pump designed for use in pressurisation units for water supply systems for domestic, civil and industrial use. Suitable for sprinkling irrigation and other water supply applications. Cast iron pump body and motor support. Technopolymer impeller. Stainless steel driving shaft. Carbon/ceramic mechanical seal. Asynchronous, closed motor, cooled by external ventilation. Built-in thermal and current overload protection and a capacitor permanently on in the single-phase version. For the protection of the three-phase motor it is advisable to use a suitable overload protection complying with the regulations in force.

### Operating range

from 1.2 to 30 m<sup>3</sup>/h with head up to 97 metres.

**Pumped liquid characteristics** clean, free from solids or abrasive substances, not viscous, not aggressive, not crystallised, chemically neutral and close to the characteristics of water.

### Liquid temperature range

from -10°C to +50°C: for K 35/40, K 45/50, K 35/100, K 40/100, K 55/100  
from -15°C to +110°C: for K 55/50, K 66/100, K 90/100, K 70/300, K 80/300, K 70/400, K 80/400.

### Maximum operating range

K 35/40, K 35/100, K 40/100: **6 bar (600 kPa)**

K 45/50, K 55/50: **8 bar (800 kPa)**

K 55/100, K 66/100: **10 bar (1000 kPa)**

K 90/100, K 70/300, K 80/300 K 70/400, K 80/400: **12 bar (1200 kPa).**

**Maximum ambient temperature** +40°C

**Protection level** IP 44

**Terminal board protection level** IP 55

**Insulation class** F

IE3 ≥ 0,75 kW

IE2 ≥ 0,75 kW

EXTRA EU

## K - TWIN IMPELLERS CENTRIFUGAL

MODEL	CODE	ELECTRICAL DATA						HYDRAULIC DATA																	DNA	DNM	KG	Q.TY x PALLET
		VOLTAGE 50 Hz	P1 MAX kW	P2 NOMIN. kW HP	In A	MOTOR TYPE	Q=m <sup>3</sup> /h	0	1,2	1,8	2,4	3,6	4,8	6	7,2	9	9,6	10,8	12	15	18	24	30					
K 35/40 M	102120004	1 x 220 - 240 V ~	1,2	0,75	1	5,5	-	43,5	41,5	40	38	33	23,5												1" G	1" G	15,9	27
K 35/40 M-P**	102122004	1 x 220 - 240 V ~	1,2	0,75	1	5,5	-	43,5	41,5	40	38	33	23,5												1" G	1" G	16,7	14
K 35/40 T	60179870	3 x 230 - 400 V ~	1,2	0,75	1	3,8-2,2	IE3	43,5	41,5	40	38	33	23,5												1" G	1" G	15	27
K 45/50 M	102120022	1 x 220 - 240 V ~	1,86	1,1	1,5	8,3	-	51	49	47,5	46	42	37	30											1 1/4" G	1" G	23,3	21
K 45/50 M-P**	102122022	1 x 220 - 240 V ~	1,86	1,1	1,5	8,3	-	51	49	47,5	46	42	37	30											1 1/4" G	1" G	24	21
K 45/50 T	60179854	3 x 230 - 400 V ~	1,8	1,1	1,5	5,9-3,4	IE3	51	49	47,5	46	42	37	30											1 1/4" G	1" G	22,5	21
K 55/50 M	102120162	1 x 220 - 240 V ~	2,7	1,85	2,5	12,8	-	62	60	58	57	52	45	34											1 1/2" G	1" G	27,2	18
K 55/50 T	60179852	3 x 230 - 400 V ~	2,4	1,85	2,5	8,4-4,8	IE3	62	60	58	57	52	45	34											1 1/2" G	1" G	23,9	21
K 35/100 M	102121002	1 x 220 - 240 V ~	1,56	1,1	1,5	7,1	-	38,5				37,5	36,5	35	32	28,5	18,5	17,5							1 1/2" G	1" G	22	21
K 35/100 T	60179877	3 x 230 - 400 V ~	1,6	1,1	1,5	6,5-3,5	IE3	38,5				37,5	36,5	35	32	28,5	18,5	17,5							1 1/2" G	1" G	21	21
K 40/100 M	102121032	1 x 220 - 240 V ~	2	1,85	2,5	9	-	44				43,4	42,5	41	39	35,7	29	26	18,5						1 1/2" G	1" G	25,9	18
K 40/100 T	60179869	3 x 230 - 400 V ~	1,8	1,85	2,5	7-4	IE3	44				43,4	42,5	41	39	35,7	29	26	18,5						1 1/2" G	1" G	22	21
K 55/100 M	60152448	1 x 230	3,4	2,2	3	14,9	-	62				59,5	57	54,5	51	47	39	36							1 1/2" G	1" G	40	18
K 55/100 T	60179373	3 x 230 - 400 V ~	3,7	2,2	3	11,6-6,7	IE3	62				59,5	57	54,5	51	47	39	36							1 1/2" G	1" G	19	18
K 66/100 M	60152449	1 x 230	4,4	3	4	19,5	-	73				70	67,5	64	60,5	57	49	47							1 1/2" G	1" G	44	18
K 66/100 T	60179857	3 x 230 - 400 V ~	5	3,7	5	14,6-8,4	IE3	73				70	67,5	64	60,5	57	49	47							1 1/2" G	1" G	40,7	18
K 90/100 M	60152450	1 x 230	5	4	5,5	21,9	-	83,5				82	79,5	76,5	72,5	68	61	58							1 1/2" G	1" G	46	18
K 90/100 T	60179859	3 x 230 - 400 V ~	5	3,7	5	16,5-9,5	IE3	83,5				82	79,5	76,5	72,5	68	61	58							1 1/2" G	1" G	44	18
K 70/300 T	60179381	3 x 400 V ~ <sup>1</sup>	6,9	5,5	7,5	12,9	-	76							74	73	72	71,5	70	69	65	60,5	43,5		2" G	1 1/4" G	72	6
K 80/300 T	60167629	3 x 400 V ~ <sup>1</sup>	9,1	7,5	10	15,2	IE3	95							93	92,2	91	90,5	90	89,5	87	82	68		2" G	1 1/4" G	78,5	6
K 70/400 T	60167630	3 x 400 V ~ <sup>1</sup>	9,2	9,2	12,5	15,5	-	86								84	83,2	82,5	82	79	76	65	47		2" G	1 1/4" G	74	6
K 80/400 T	60167631	3 x 400 V ~ <sup>1</sup>	10,8	11	15	18,5	-	97									95	94,5	94	92	89	80	64		2" G	1 1/4" G	79	6

<sup>1</sup> Star (Λ) starting is possible

\*\* Pump equipped with pressure gauge, pressure switch, power cable with plug and five -way fitting to use for connecting to a tank.

# K TWIN IMPELLERS

TWIN IMPELLERS CENTRIFUGAL PUMPS



IE3 ≥ 0,75 kW

IE2 ≥ 0,75 kW

EXTRA EU

## K - TWIN IMPELLERS CENTRIFUGAL

MODEL	CODE	ELECTRICAL DATA						HYDRAULIC DATA													DNA	DNM	KG	Q.TY x PALLET			
		VOLTAGE 50 Hz	P1 MAX kW	P2 NOMINAL		In A	MOTOR TYPE	Q=m³/h																			
				kW	HP			0	1,2	1,8	2,4	3,6	4,8	6	7,2	9	9,6	10,8	0	20					30	40	60
K 35/40 T	60145196	3 x 230 - 400 V ~	1,2	0,75	1	3,8-2,2	IE2	H (m)	43,5	41,5	40	38	33	23,5									1" G	1" G	15	27	
K 45/50 T	60145774	3 x 230 - 400 V ~	1,96	1,1	1,5	7,2-4			51	49	47,5	46	42	37	30									1½" G	1" G	22,5	21
K 55/50 T	60145840	3 x 230 - 400 V ~	2,5	1,85	2,5	8,4-4,8			62	60	58	57	52	45	34									1½" G	1" G	23,9	21
K 35/100 T	60145775	3 x 230 - 400 V ~	1,65	1,1	1,5	6,5-3,5			38,5				37,5	36,5	35	32	28,5	18,5	17,5					1½" G	1" G	21	21
K 40/100 T	60145841	3 x 230 - 400 V ~	2	1,85	2,5	7-4			44				43,4	42,5	41	39	35,7	29	26	18,5				1½" G	1" G	22	21
K 55/100 T	60146054	3 x 230 - 400 V ~	3,9	2,2	3	11,6-6,7			62				59,5	57	54,5	51	47	39	36					1½" G	1" G	38,1	18
K 66/100 T	60146067	3 x 230 - 400 V ~	4,7	3	4	14,6-8,4			73				70	67,5	64	60,5	57	49	47					1½" G	1" G	40,7	18
K 90/100 T	60146068	3 x 230 - 400 V ~	5,4	4	5,5	16,5-9,5			83,5				82	79,5	76,5	72,5	68	61	58					1½" G	1" G	44	18

\* Star (Λ) starting is possible

## K - TWIN IMPELLERS CENTRIFUGAL - SINGLE-PHASE

MODEL	CODE	ELECTRICAL DATA					HYDRAULIC DATA																			DNA	DNM	Kg	Q.TY x PALLET												
		VOLTAGE 50 Hz	P1 MAX kW	P2 NOMINAL		In A	Q=m³/h																																		
				kW	HP		0	1,2	1,8	2,4	3,6	4,8	6	7,2	9	9,6	10,8	12	15	18	24	30	0	20	30					40	60	80	100	120	150	160	180	200	250	300	400
K 55/100 M	60152448	1 x 230	3,4	2,2	3	14,9	H (m)	62			59,5	57	54,5	51	47	39	36																					1½" G	1" G	38,1	18
K 66/100 M	60152449	1 x 230	4,4	3	4	19,5		73				70	67,5	64	60,5	57	49	47																				1½" G	1" G	40,7	18
K 90/100 M	60152450	1 x 230	5,0	4	5,5	21,9		83,5				82	79,5	76,5	72,5	68	61	58																					1½" G	1" G	44

# KC / KCV

## CENTRIFUGAL PUMPS FOR AIR CONDITIONING



KC



KCV

Pumping of water or other non-aggressive non-explosive liquids that do not contain solid particles or fibre. Especially suitable for handling water and glycol solutions in air conditioning circuits.

**- PLUS**

**VERSATILE:** thanks to the high quality construction materials and oversized motors, the KC and KCV series of pumps can be used in surroundings with temperatures up to 65°C and a glycol percentage of as much as 40% in the handled liquid.

**RELIABLE:** all components are sized to guarantee a working life of at least 50,000 duty hours (with the exception of the bearings and mechanical seals, the manufacturers of which guarantee an average life of 25,000 hours in the most severe duty conditions)

**RUST PROOF:** all components in contact with the liquid are made of thermoplastic (polypropylene or reinforced Noryl) and the pump shaft is made of AISI 304 stainless steel

**FLEXIBLE:** facility to rotate the pump body in steps of 90° for greater installation flexibility.

Complete hydraulic section (pump body, seal holder flange, impeller, diffuser) made of fibreglass reinforced technopolymer, shaft extension in contact with liquid in AISI 304 stainless steel, mechanical seal in silicon carbide/graphite.

O-rings in EPDM Externally cooled asynchronous motor for continuous duty (S1), 2 poles

**Maximum ambient temperature** 65°C

**Motor protection rating** IP55

**Insulation class**

F (copper wire with class H insulation)

**Standard input voltage**

three-phase 230-400 V/50 Hz

Sealed, water resistant and humidity resistant ball bearings Motor construction to EN 60335-2-41

**Operating range** from 3 to 45 m<sup>3</sup>/h

**Maximum head** 24 m

**Maximum working pressure** 6.5 bar

**Liquid temperature range** from -10 to +55°C

**Maximum glycol contents** up to 40%

**Installation** fixed or portable in horizontal position

**Pumped liquid**

Maximum ambient temperature: 65 °C

**Special versions on request**

alternative voltages and/or frequencies.

**IE3 ≥ 0,75 kW**

MODEL	CODE	ELECTRICAL DATA					HYDRAULIC DATA								DNA	DNM	WEIGHT KG
		VOLTAGE 50 Hz	P1 MAX kW	P2 (W)	In A	RESISTANCE MOTOR STARTER (Ohm)	Q=m <sup>3</sup> /h	0	10	15	20	25	30	40			
							Q=l/min	0	167	250	333	417	500	667			
<b>KC 150 T</b>	60180128	3 x 230 - 400 V ~	1,2	870	2,3	6,28	H (m)	13,6	12,8	11,5	9,5	6,5			2" m gas	2" m gas	14
<b>KC 200 T</b>	60180129	3 x 230 - 400 V ~	1,5	1260	3,1	3,51		16,8	15,7	15	14	11,8	9		2" gas	2" gas	16
<b>KC 250 T</b>	60180130	3 x 230 - 400 V ~	2,3	1900	4,3	2,55		21	20	19,1	17,7	15,5	12		2" m gas	2" m gas	19
<b>KC 300 T</b>	60180131	3 x 230 - 400 V ~	3	2560	5,8	1,72		24,3		23,4	22,5	21,3	19,5	13,9	2" gas	2" gas	23
<b>KCV 150 T</b>	60180132	3 x 230 - 400 V ~	1,2	870	2,3	6,28		13,6	12,8	11,5	9,5	6,5			2" Victaulic	2" Victaulic	14
<b>KCV 200 T</b>	60180133	3 x 230 - 400 V ~	1,5	1260	3,1	3,51		16,8	15,7	15	14	11,8	9		2" Victaulic	2" Victaulic	16
<b>KCV 250 T</b>	60179377	3 x 230 - 400 V ~	2,3	1900	4,3	2,55		21	20	19,1	17,7	15,5	12		2" Victaulic	2" Victaulic	19
<b>KCV 300 T</b>	60179378	3 x 230 - 400 V ~	3	2560	5,8	1,72		24,3		23,4	22,5	21,3	19,5	13,9	2" Victaulic	2" Victaulic	23

# NKM-G / NKP-G

STANDARDISED ENBLOC CENTRIFUGAL PUMPS



Enbloc centrifugal electric pumps with integral shaft designed for a wide range of applications, such as:

- Water supply
- Circulation of hot water for central heating.
- Circulation of cold water for air conditioning and refrigerating.
- Transfer of liquids in agriculture, horticulture and industries.
- Implementation of pumping systems

#### Pump construction characteristics:

Single-stage, cast iron spiral body made to DIN-EN 733 (formerly DIN 24255), cast iron support, flanges in accordance with DIN 2533. Cast iron impeller, encased and dynamically balanced with compensation of the axial thrust by means of balancing holes, operating (on request) with interchangeable consumable rings. AISI 304 stainless steel pump shaft.

Seal: standardised mechanical seal made to DIN 24960 in carbon / carborundum with O' rings in EPDM.

#### Motor construction characteristics

Closed, asynchronous motor with external ventilation, 2 poles for NKP and 4 poles for NKM. Rotor mounted on oversized ball bearings to ensure silent running and long life. We recommend using overload protection for the motor, in accordance with current norms. In the case of liquids denser than water, the motors must be proportionally more powerful.

**Built to** IEC 2-3 standards

**Protection level** IP 55

**Insulation level** F

**Standard voltage** 230/400 V 50 Hz up to 2,2 Kw included 400 V 50 Hz over 2,2 Kw

**Speed of rotation** 1450 - 2900 1/min.

#### Operating range

from 1 to 105 m<sup>3</sup>/h with head up to 96 metres.

**Characteristics of pumped liquid** clean, free from solids or abrasive substances, not viscous, not aggressive, not crystallised and chemically neutral and close to the characteristics of water.

#### Liquid temperature range

from -10°C to +140°C

**Maximum ambient temperature** +40°C

#### Maximum operating pressure

16 bar - 1600 kPa

**Flanging** PN 16 DIN 2533

**Installation** normally horizontal or vertical provided the motor is always above the pump.

#### Special versions on request

pumps for liquids other than water.  
Other voltages and/or frequencies.

IE3 ≥ 0,75 kW

ACCESSORIES  
PAG. 207

## NKM-G - STANDARDISED ENBLOC - 4 POLES

CAST IRON IMPELLER

≈ 1450 1/min

MODEL	CODE	ELECTRICAL DATA					HYDRAULIC DATA								DNA	DNM	WEIGHT KG								
		VOLTAGE 50 Hz	P2 NOMINAL		In (A)		Q=m <sup>3</sup> /h	0	6	12	18	24	30	36				Q=1/min	0	100	200	300	400	500	600
			kW	HP	230V	400V	H (m)																		
NKM-G 32-125.1/140/A/BAQE/0.25/4	1D1K11BX3	3 x 230 - 400 V ~	0.25	0.33	1,56	0,9	6.2	5.8	4.2						50	32	32,8								
NKM-G 32-125/142/A/BAQE/0.37/4	1D1111B13	3 x 230 - 400 V ~	0.37	0.5	1,69	1	7	6.75	5.85	4.2					50	32	33,5								
NKM-G 32-160.1 169/A/BAQE/0.37/4	1D1L11B13	3 x 230 - 400 V ~	0.37	0.5	1,69	1	8.9	8.2	4.6						50	32	35,6								
NKM-G 32-160/169/A/BAQE/0,55/4	1D1211B23	3 x 230 - 400 V ~	0.55	0.75	2,6	1,5	9.4	9	7.9	5.6					50	32	39,8								
NKM-G 32-200.1 200/A/BAQE/0,55/4	1D1M11B23	3 x 230 - 400 V ~	0.55	0.75	2,6	1,5	12.7	11.2	7.2						50	32	45								
NKM-G 32-200/200/A/BAQE/0,75/4	1D1311B3W	3 x 230 - 400 V ~	0.75	1	3,12	1,8	13	12.5	11.1	8.45					50	32	42								
NKM-G 32-200/219/A/BAQE/1,1/4	1D1311B4W	3 x 230 - 400 V ~	1.1	1.5	4,33	2,5	16	15.4	14.3	12.2					50	32	41								
NKM-G 40-125/115/A/BAQE/0.25/4	1D2111B13	3 x 230 - 400 V ~	0.25	0.33	1,56	0,9	4.2	4.1	3.7	3	2.1				65	40	34,2								
NKM-G 40-125/130/A/BAQE/0.37/4	1D2111B23	3 x 230 - 400 V ~	0.37	0.5	1,69	1	5.4	5.3	5	4.4	3.5				65	40	35,3								
NKM-G 40-125/142/A/BAQE/0.55/4	1D2111BX3	3 x 230 - 400 V ~	0.55	0.75	2,60	1,5	6.6	6.5	6.2	5.7	4.8				65	40	39,4								
NKM-G 40-160/153/A/BAQE/0.55/4	1D2211B23	3 x 230 - 400 V ~	0.55	0.75	2,60	1,5	7.6	7.6	7.5	6.7	5.5				65	40	40								
NKM-G 40-160/166/A/BAQE/0.75/4	1D2211B3W	3 x 230 - 400 V ~	0.75	1	3,12	1,8	9.2	9.2	9	8.4	7.4	5.7			65	40	35								
NKM-G 40-200/200/A/BAQE/1,1/4	1D2311B4W	3 x 230 - 400 V ~	1.1	1.5	4,3	2,5	12.5	12.5	12.3	11.2	9.7	7.7			65	40	41								
NKM-G 40-200/219/A/BAQE/1,5/4	1D2311B5W	3 x 230 - 400 V ~	1.5	2	6,24	3,6	15.6	15.6	15.3	14.7	13.4	11.8	9.8		65	40	42								
NKM-G 40-250/245/A/BAQE/2,2/4	1D2411B6W	3 x 230 - 400 V ~	2.2	3	10,22	5,9	20.6	20.5	20.1	19.2	17.8	16			65	40	63								
NKM-G 40-250/260/A/BAQE/3/4	1D2411B7X	3 x 400 V ~	3	4	-	6,8	23.3	23.1	22.8	22.2	20.8	19			65	40	59								



# NKM-G

STANDARDISED ENBLOC CENTRIFUGAL PUMPS



## NKM-G - STANDARDISED ENBLOC - 4 POLES

**CAST IRON IMPELLER**

≅ 1450 1/min

MODEL	CODE	ELECTRICAL DATA				HYDRAULIC DATA															DNA	DNM	KG					
		VOLTAGE 50 Hz	P2 NOMINAL		In (A)		Q=m³/h																					
			kW	HP	230V	400V	Q=l/min	0	12	18	24	30	36	42	48	54	60	66	72	78				84	90	102	114	
NKM-G 50-125/130/A/ BAQE/0.55/4	1D3111B23	3 x 230 - 400 V ~	0.55	0.75	2,60	1,5																				65	50	43
NKM-G 50-125/141/A/ BAQE/0.75/4	1D3111B3W	3 x 230 - 400 V ~	0.75	1	3,12	1,8																				65	50	37
NKM-G 50-160/161/A/ BAQE/1.1/4	1D3211B4W	3 x 230 - 400 V ~	1.1	1.5	4,33	2,5																				65	50	37
NKM-G 50-160/177/A/ BAQE/1,5/4	1D3211B5W	3 x 230 - 400 V ~	1.5	2	6,24	3,6																				65	50	35
NKM-G 50-200/210/A/ BAQE/2,2/4	1D3311B6W	3 x 230 - 400 V ~	2.2	3	10,22	5,9																				65	50	55
NKM-G 50-200/219/A/ BAQE/3/4	1D3311B7X	3 x 400 V ~	3	4	-	6,8																				65	50	52
NKM-G 50-250/263/A/ BAQE/4/4	1D3411B8X	3 x 400 V ~	4	5.5	-	8,2																				65	50	56
NKM-G 65-125/130/A/ BAQE/0.75/4	1D4111B3W	3 x 230 - 400 V ~	0.75	1	3,12	1,8																				80	65	52
NKM-G 65-125/144/A/ BAQE/1.1/4	1D4111B4W	3 x 230 - 400 V ~	1.1	1.5	4,33	2,5																				80	65	39
NKM-G 65-160/153/A/ BAQE/1,1/4	1D4211B4W	3 x 230 - 400 V ~	1.1	1.5	4,33	2,5																				80	65	42
NKM-G 65-160/165/A/ BAQE/1,5/4	1D4211B5W	3 x 230 - 400 V ~	1.5	2	6,24	3,6																				80	65	40
NKM-G 65-160/177/A/ BAQE/2,2/4	1D4211B6W	3 x 230 - 400 V ~	2.2	3	10,22	5,9																				80	65	52
NKM-G 65-200/210/A/ BAQE/3/4	1D4311B7X	3 x 400 V ~	3	4	-	6,8																				80	65	56
NKM-G 65-200/219/A/ BAQE/4/4	1D4311B8X	3 x 400 V ~	4	5.5	-	8,2																				80	65	58
NKM-G 65-250/263/A/ BAQE/5,5/4	1D4411B9X	3 x 400 V ~	5.5	7.5	-	10,6																				80	65	142
NKM-G 65-315/279/A/ BAQE/7,5/4	1D4511BAX	3 x 400 V ~	7.5	10	-	14,4																				80	65	163
NKM-G 65-315/309/A/ BAQE/11/4	1D4511BBX	3 x 400 V ~	11	15	-	22,4																				80	65	231

H  
(m)

# NKM-G

STANDARDISED ENBLOC CENTRIFUGAL PUMPS



## NKM-G - STANDARDISED ENBLOC - 4 POLES

CAST IRON IMPELLER

≈ 1450 1/min

MODEL	CODE	ELECTRICAL DATA					HYDRAULIC DATA																		DNA	DNM	KG			
		VOLTAGE 50 Hz		P2 NOMINAL		In (A)	Q=m³/h	0	30	36	42	48	54	60	66	72	78	84	90	102	114	120	150	180						
		kW	HP	230V	400V	Q=l/min	0	500	600	700	800	900	1000	1100	1200	1300	1400	1500	1700	1900	2000	2500	3000							
NKM-G 80-160/153-136/A/BAQE/1.5/4	1D5211B5W	3 x 230 - 400 V ~	1.5	2	6,24	3,6	H (m)	6.5	6.35	6.3	6.2	5.95	5.75	5.55	5.3	5	4.7	4.5	4.25	3.65	3						100	80	46	
NKM-G 80-160/163/A/BAQE/2,2/4	1D5211B6W	3 x 230 - 400 V ~	2.2	3	10,22	5,9		8.65	8.5	8.45	8.3	8.15	7.9	7.7	7.4	7.2	6.9	6.65	6.3	5.7	4.9	4.6						100	80	61
NKM-G 80-160/177/A/BAQE/3/4	1D5211B7X	3 x 400 V ~	3	4	-	6,8		10.2	10.2	10.1	10	9.9	9.75	9.65	9.5	9.25	9	8.8	8.6	7.9	7.2	6.7						100	80	58
NKM-G 80-200/200/A/BAQE/4/4	1D5311B8X	3 x 400 V ~	4	5.5	-	8,2		13.2			13.1	13	12.9	12.8	12.7	12.4	12	11.7	11.3	10.4	9.3	8.7						100	80	83
NKM-G 80-200/222/A/BAQE/5,5/4	1D5311B9X	3 x 400 V ~	5.5	7.5	-	10,6		16.6			16.5	16.5	16.4	16.2	16.1	16	15.7	15.4	15	14.3	13.3	12.7						100	80	130
NKM-G 80-250/240/A/BAQE/7,5/4	1D5411BAX	3 x 400 V ~	7.5	10	-	14,4		20.4			20.3	20.3	20.2	20.1	20	19.9	19.8	19.5	19	18	16.7	16						100	80	153
NKM-G 80-250/270/A/BAQE/11/4	1D5411BBX	3 x 400 V ~	11	15	-	22,4		25.6			25.5	25.5	25.4	25.1	25	24.8	24.6	24.2	24	23	21.5	21						100	80	205
NKM-G 80-315/305/A/BAQE/15/4	1D5511BCX	3 x 400 V ~	15	20	-	30,5		32.9					32.7	32.6	32.6	32.5	32.4	32	31.6	30.5	29.5	28.9	24					100	80	263
NKM-G 80-315/320/A/BAQE/18,5/4	1D5511BDX	3 x 400 V ~	18.5	25	-	34,3		36.8					36.7	36.7	36.6	36.5	36.5	36.5	36.1	35.5	34.5	34	29.5					100	80	275
NKM-G 80-315/334/A/BAQE/22/4	1D5511BEX	3 x 400 V ~	22	30	-	40,2		41					40.8	40.8	40.7	40.6	40.6	40.4	40.2	39.8	39	38.5	34.8	29				100	80	298

MODEL	CODE	ELECTRICAL DATA					HYDRAULIC DATA																		DNA	DNM	KG				
		VOLTAGE 50 Hz		P2 NOMINAL		In (A)	Q=m³/h	0	60	66	72	78	84	90	102	114	120	150	180	210											
		kW	HP	Q=l/min	0	1000	1100	1200	1300	1400	1500	1700	1900	2000	2500	3000	3500														
NKM-G100-200/200/A/BAQE/5.5/4	1D6311B9X	3 x 400 V ~	5.5	7.5	10,6	H (m)	12.7	12.6	12.6	12.5	12.5	12.4	12.3	12	11.5	11.4	10.1	8.5										125	100	166	
NKM-G100-200/214/A/BAQE/7.5/4	1D6311BAX	3 x 400 V ~	7.5	10	14,4		15.6	15.4	15.4	15.3	15.2	15.1	15	14.7	14.5	14.3	13.3	11.6	9.8									125	100	149	
NKM-G100-250/250/A/BAQE/11/4	1D6411BBX	3 x 400 V ~	11	15	22,4		21.1	21	21	21	21	21	21	20.9	20	19.8	18	16										125	100	213	
NKM-G100-250/270/A/BAQE/15/4	1D6411BCX	3 x 400 V ~	15	20	30,5		25.5	25.5	25.5	25.5	25.3	25.1	25.1	25	24.5	24	22.5	20.5	17.5										125	100	237
NKM-G100-315/300/A/BAQE/18.5/4	1D6511BDX	3 x 400 V ~	18.5	25	34,3		32						31.5	31.4	31	30.5	28.8	26	23										125	100	257
NKM-G100-315/316/A/BAQE/22/4	1D6511BEX	3 x 400 V ~	22	30	40,2		36							35.5	35.2	35	34.6	33.2	31	28	24								125	100	272

MODEL	CODE	ELECTRICAL DATA					HYDRAULIC DATA																		DNA	DNM	KG				
		VOLTAGE 50 Hz		P2 NOMINAL		In (A)	Q=m³/h	0	102	114	120	150	180	210	240	270	300	330	360	390	420										
		kW	HP	Q=l/min	0	1700	1900	2000	2500	3000	3500	4000	4500	5000	5500	6000	6500	7000													
NKM-G125-250/243/A/BAQE/15/4	1D7411BCX	3 x 400 V ~	15	20	30,5	H (m)	19.5	19.3	19.3	19.2	19.2	18.7	17.8	16.8	15.5	14.1	12.5	10.9											150	125	274
NKM-G125-250/256/A/BAQE/18,5/4	1D7411BDX	3 x 400 V ~	18.5	25	34,3		21.9	21.8	21.8	21.7	21.6	21.3	20.5	19.5	18.5	17.2	15.6	14	12									150	125	290	
NKM-G125-250/266/A/BAQE/22/4	1D7411BEX	3 x 400 V ~	22	30	40,2		24.6	24.4	24.2	24.1	24	23.5	22.9	22	21	19.8	18.5	16.7	15									150	125	309	
NKM-G150-200/218/A/BAQE/11/4	1D8311BBX	3 x 400 V ~	11	15	22,4		13.2	13.1	13	13	12.8	12.5	12.1	11.5	11	10.4	9.7	9	8	7									150	125	280

# NKM-G

STANDARDISED ENBLOC CENTRIFUGAL PUMPS



## NKM-G - STANDARDISED ENBLOC - 4 POLES

**BRONZE IMPELLER**

≈ 1450 1/min

MODEL	CODE	ELECTRICAL DATA						HYDRAULIC DATA								DNA	DNM	KG		
		VOLTAGE 50 Hz	P2 NOMINAL		In (A)		Q=m³/h	0	6	12	18	24	30	36						
			kW	HP	230V	400V	Q=l/min	0	100	200	300	400	500	600						
NKM-G 32-125.1/ 140/B/BAQE/0.25/4	1D1121B13	3 x 230 - 400 V ~	0.25	0.33	1,56	0,9	H (m)d	6.2	5.8	4.2							50	32	32,8	
NKM-G 32-125/142/B/ BAQE/0.37/4	1D1221B23	3 x 230 - 400 V ~	0.37	0.5	1,69	1		7	6.75	5.85	4.2							50	32	33,5
NKM-G 32-160.1/ 169/B/BAQE/0.37/4	1D1321B3W	3 x 230 - 400 V ~	0.37	0.5	1,69	1		8.9	8.2	4.6								50	32	35,6
NKM-G 32-160/169/B/ BAQE/0,55/4	1D1321B4W	3 x 230 - 400 V ~	0.55	0.75	2,6	1,5		9.4	9	7.9	5.6							50	32	39,8
NKM-G 32-200.1/200/B/ BAQE/0,55/4	1D1K21BX3	3 x 230 - 400 V ~	0.55	0.75	2,6	1,5		12.7	11.2	7.2								50	32	45
NKM-G 32-200/200/B/ BAQE/0,75/4	1D1L21B13	3 x 230 - 400 V ~	0.75	1	3,12	1,8		13	12.5	11.1	8.45							50	32	42
NKM-G 32-200/219/B/ BAQE/1,1/4	1D1M21B23	3 x 230 - 400 V ~	1.1	1.5	4,33	2,5		16	15.4	14.3	12.2							50	32	41
NKM-G 40-125/115/B/ BAQE/0.25/4	1D2121B13	3 x 230 - 400 V ~	0.25	0.33	1,56	0,9		4.2	4.1	3.7	3	2.1						65	40	34,2
NKM-G 40-125/130/B/ BAQE/0.37/4	1D2121B23	3 x 230 - 400 V ~	0.37	0.5	1,69	1		5.4	5.3	5	4.4	3.5						65	40	35,3
NKM-G 40-125/142/B/ BAQE/0.55/4	1D2121BX3	3 x 230 - 400 V ~	0.55	0.75	2,60	1,5		6.6	6.5	6.2	5.7	4.8						65	40	39,4
NKM-G 40-160/153/B/ BAQE/0.55/4	1D2221B23	3 x 230 - 400 V ~	0.55	0.75	2,60	1,5		7.6	7.6	7.5	6.7	5.5						65	40	40
NKM-G 40-160/166/B/ BAQE/0.75/4	1D2221B3W	3 x 230 - 400 V ~	0.75	1	3,12	1,8		9.2	9.2	9	8.4	7.4	5.7					65	40	35
NKM-G 40-200/200/B/ BAQE/1,1/4	1D2321B4W	3 x 230 - 400 V ~	1.1	1.5	4,3	2,5		12.5	12.5	12.3	11.2	9.7	7.7					65	40	41
NKM-G 40-200/219/B/ BAQE/1,5/4	1D2321B5W	3 x 230 - 400 V ~	1.5	2	6,24	3,6		15.6	15.6	15.3	14.7	13.4	11.8	9.8				65	40	42
NKM-G 40-250/245/B/ BAQE/2,2/4	1D2421B6W	3 x 230 - 400 V ~	2.2	3	10,22	5,9		20.6	20.5	20.1	19.2	17.8	16					65	40	63
NKM-G 40-250/260/B/ BAQE/3/4	1D2421B7X	3 x 400 V ~	3	4	-	6,8		23.3	23.1	22.8	22.2	20.8	19					65	40	59

COMMAND AND  
CONTROL SYSTEMS

CIRCULATORS AND  
IN-LINE PUMPS

MULTISTAGE CENTRIFUGAL  
AND SELF-PRIMING PUMPS

SWIMMING POOL, POND AND  
SALT WATER PUMPS

CENTRIFUGAL PUMPS

SUBMERSIBLE PUMPS

SUBMERSIBLE PUMPS  
AND SUBMERSIBLE MOTORS

PRESSURE UNITS

# NKM-G

STANDARDISED ENBLOC CENTRIFUGAL PUMPS



## NKM-G - STANDARDISED ENBLOC - 4 POLES

**BRONZE IMPELLER**

≈ 1450 1/min

MODEL	CODE	ELECTRICAL DATA				HYDRAULIC DATA																DNA	DNM	KG							
		VOLTAGE 50 Hz	P2 NOMINAL		In (A)	Q=m³/h	Q=l/min																								
			KW	HP			230V	400V	0	12	18	24	30	36	42	48	54	60	66	72	78				84	90	102	114			
NKM-G 50-125/130/B/ BAQE/0.55/4	1D3121B23	3 x 230 - 400 V ~	0.55	0.75	2,60	1,5		5.5	5.2	5	4.7	4.3	3.9	3.3	2.6														65	50	43
NKM-G 50-125/141/B/ BAQE/0.75/4	1D3121B3W	3 x 230 - 400 V ~	0.75	1	3,12	1,8		6.5	6.3	6.1	5.8	5.5	5	4.5	3.9														65	50	38
NKM-G 50-160/161/B/ BAQE/1.1/4	1D3221B4W	3 x 230 - 400 V ~	1.1	1.5	4,33	2,5		8.6	8.6	8.5	8.2	7.8	7.3	6.7	5.7														65	50	37
NKM-G 50-160/177/B/ BAQE/1,5/4	1D3221B5W	3 x 230 - 400 V ~	1.5	2	6,24	3,6		10.7	10.7	10.7	10.5	10.2	9.8	9.2	8.3														65	50	35
NKM-G 50-200/210/B/ BAQE/2,2/4	1D3321B6W	3 x 230 - 400 V ~	2.2	3	10,22	5,9		15.3	15.3	15.2	14.8	14	13.3	12.1	10.8	9.4													65	50	54
NKM-G 50-200/219/B/ BAQE/3/4	1D3321B7X	3 x 400 V ~	3	4	-	6,8		16.8	16.8	16.5	16.1	15.5	14.6	13.6	12.4	10.9													65	50	52
NKM-G 50-250/263/B/ BAQE/4/4	1D3421B8X	3 x 400 V ~	4	5.5	-	8,2		23.8	23.8	23.8	23.4	22.7	21.6	20.4	19	17.1													65	50	56
NKM-G 65-125/130/B/ BAQE/0.75/4	1D4121B3W	3 x 230 - 400 V ~	0.75	1	3,12	1,8		5.1	4.9	4.8	4.75	4.7	4.4	4.2	3.8	3.4	3	2.5											80	65	52
NKM-G 65-125/144/B/ BAQE/1.1/4	1D4121B4W	3 x 230 - 400 V ~	1.1	1.5	4,33	2,5		6.5	6.4	6.4	6.3	6.2	6	5.75	5.5	5.1	4.65	4.2	3.75										80	65	39
NKM-G 65-160/153/B/ BAQE/1,1/4	1D4221B4W	3 x 230 - 400 V ~	1.1	1.5	4,33	2,5		7.4	7.4	7.3	7.15	6.9	6.65	6.25	5.8	5.3	4.4												80	65	42
NKM-G 65-160/165/B/ BAQE/1,5/4	1D4221B5W	3 x 230 - 400 V ~	1.5	2	6,24	3,6		8.9		8.8	8.7	8.6	8.3	8	7.6	7.15	6.6	6											80	65	40
NKM-G 65-160/177/B/ BAQE/2,2/4	1D4221B6W	3 x 230 - 400 V ~	2.2	3	10,22	5,9		10.5			10.4	10.3	10.2	9.9	9.6	9.2	8.75	8.2	7.4	6.6									80	65	52
NKM-G 65-200/210/B/ BAQE/3/4	1D4321B7X	3 x 400 V ~	3	4	-	6,8		15.3			15.2	15.2	15.1	14.6	14.1	13.5	12.9	12.2	11.3										80	65	56
NKM-G 65-200/219/B/ BAQE/4/4	1D4321B8X	3 x 400 V ~	4	5.5	-	8,2		17			17	16.9	16.8	16.4	16.2	15.8	15.2	14.3	13.8	12.6									80	65	58
NKM-G 65-250/263/B/ BAQE/5,5/4	1D4421B9X	3 x 400 V ~	5.5	7.5	-	10,6		24.1			23.8	23.6	23.3	22.8	22.3	21.5	20.8	19.7	18.6	17.3									80	65	142
NKM-G 65-315/279/B/ BAQE/7,5/4	1D4521BAX	3 x 400 V ~	7.5	10	-	14,4		27						26	25.5	25	24.5	23.6	22.7	21.5	20.2	19						80	65	163	
NKM-G 65-315/309/B/ BAQE/11/4	1D4521BBX	3 x 400 V ~	11	15	-	22,4		34.2							33.2	33	32.5	32	31.5	30.7	29.8	29	28	25	21.7			80	65	231	

H  
(m)

COMMAND AND  
CONTROL SYSTEMS

CIRCULATORS AND  
IN-LINE PUMPS

MULTISTAGE CENTRIFUGAL  
AND SELF-PRIMING PUMPS

SWIMMING POOL, POND AND  
SALT WATER PUMPS

CENTRIFUGAL PUMPS

SUBMERSIBLE PUMPS

SUBMERSIBLE PUMPS  
AND SUBMERSIBLE MOTORS

PRESSURE UNITS

# NKM-G

STANDARDISED ENBLOC CENTRIFUGAL PUMPS



## NKM-G - STANDARDISED ENBLOC - 4 POLES

**BRONZE IMPELLER**

≅ 1450 1/min

MODEL	CODE	ELECTRICAL DATA				HYDRAULIC DATA																		DNA	DNM	KG				
		VOLTAGE 50 Hz		P2 NOMINAL		In (A)	Q=m³/h	Q=l/min																						
		kW	HP	230V	400V			0	30	36	42	48	54	60	66	72	78	84	90	102	114	120	150				180			
NKM-G 80-160/153-136/B/BAQE/1,5/4	1D5221B5W	3 x 230 - 400 V ~	1.5	2	6,24	3,6	H (m)	6.5	6.35	6.3	6.2	5.95	5.75	5.55	5.3	5	4.7	4.5	4.25	3.65	3						100	80	46	
NKM-G 80-160/163/B/BAQE/2,2/4	1D5221B6W	3 x 230 - 400 V ~	2.2	3	10,22	5,9		8.65	8.5	8.45	8.3	8.15	7.9	7.7	7.4	7.2	6.9	6.65	6.3	5.7	4.9	4.6						100	80	61
NKM-G 80-160/177/B/BAQE/3/4	1D5221B7X	3 x 400 V ~	3	4	-	6,8		10.2	10.2	10.1	10	9.9	9.75	9.65	9.5	9.25	9	8.8	8.6	7.9	7.2	6.7						100	80	58
NKM-G 80-200/200/B/BAQE/4/4	1D5321B8X	3 x 400 V ~	4	5.5	-	8,2		13.2			13.1	13	12.9	12.8	12.7	12.4	12	11.7	11.3	10.4	9.3	8.7						100	80	84
NKM-G 80-200/222/B/BAQE/5,5/4	1D5321B9X	3 x 400 V ~	5.5	7.5	-	10,6		16.6			16.5	16.5	16.4	16.2	16.1	16	15.7	15.4	15	14.3	13.3	12.7						100	80	130
NKM-G 80-250/240/B/BAQE/7,5/4	1D5421BAX	3 x 400 V ~	7.5	10	-	14,4		20.4			20.3	20.3	20.2	20.1	20	19.9	19.8	19.5	19	18	16.7	16						100	80	153
NKM-G 80-250/270/B/BAQE/11/4	1D5421BBX	3 x 400 V ~	11	15	-	22,4		25.6			25.5	25.5	25.4	25.1	25	24.8	24.6	24.2	24	23	21.5	21						100	80	205
NKM-G 80-315/305/B/BAQE/15/4	1D5521BCX	3 x 400 V ~	15	20	-	30,5		32.9					32.7	32.6	32.6	32.5	32.4	32	31.6	30.5	29.5	28.9	24					100	80	263
NKM-G 80-315/320/B/BAQE/18,5/4	1D5521BDX	3 x 400 V ~	18.5	25	-	34,3		36.8					36.7	36.6	36.6	36.5	36.5	36.5	36.1	35.5	34.5	34	29.5					100	80	275
NKM-G 80-315/334/B/BAQE/22/4	1D5521BEX	3 x 400 V ~	22	30	-	40,2		41					40.8	40.8	40.7	40.6	40.6	40.4	40.2	39.8	39	38.5	34.8	29				100	80	298

MODEL	CODE	ELECTRICAL DATA				HYDRAULIC DATA																		DNA	DNM	KG				
		VOLTAGE 50 Hz		P2 NOMINAL		In (A)	Q=m³/h	Q=l/min																						
		kW	HP	0	60			66	72	78	84	90	102	114	120	150	180	210												
NKM-G100-200/200/B/BAQE/5.5/4	1D6321B9X	3 x 400 V ~	5.5	7.5	10,6	H (m)	12.7	12.6	12.6	12.5	12.5	12.4	12.3	12	11.5	11.4	10.1	8.5									125	100	142	
NKM-G100-200/214/B/BAQE/7.5/4	1D6321BAX	3 x 400 V ~	7.5	10	14,4		15.6	15.4	15.4	15.3	15.2	15.1	15	14.7	14.5	14.3	13.3	11.6	9.8								125	100	149	
NKM-G100-250/250/B/BAQE/11/4	1D6421BBX	3 x 400 V ~	11	15	22,4		21.1	21	21	21	21	21	21	20.9	20	19.8	18	16									125	100	213	
NKM-G100-250/270/B/BAQE/15/4	1D6421BCX	3 x 400 V ~	15	20	30,5		25.5	25.5	25.5	25.5	25.3	25.1	25.1	25	24.5	24	22.5	20.5	17.5									125	100	237
NKM-G100-315/300/B/BAQE/18.5/4	1D6521BDX	3 x 400 V ~	18.5	25	34,3		32						31.5	31.4	31	30.5	28.8	26	23									125	100	257
NKM-G100-315/316/B/BAQE/22/4	1D6521BEX	3 x 400 V ~	22	30	40,2		36							35.5	35.2	35	34.6	33.2	31	28	24							125	100	272

MODEL	CODE	ELECTRICAL DATA				HYDRAULIC DATA																		DNA	DNM	KG					
		VOLTAGE 50 Hz		P2 NOMINAL		In (A)	Q=m³/h	Q=l/min																							
		kW	HP	0	102			114	120	150	180	210	240	270	300	330	360	390	420												
NKM-G125-250/243/B/BAQE/15/4	1D7421BCX	3 x 400 V ~	15	20	30,5	H (m)	19.5	19.3	19.3	19.2	19.2	18.7	17.8	16.8	15.5	14.1	12.5	10.9											150	125	274
NKM-G125-250/256/B/BAQE/18,5/4	1D7421BDX	3 x 400 V ~	18.5	25	34,3		21.9	21.8	21.8	21.7	21.6	21.3	20.5	19.5	18.5	17.2	15.6	14	12									150	125	290	
NKM-G125-250/266/B/BAQE/22/4	1D7421BEX	3 x 400 V ~	22	30	40,2		24.6	24.4	24.2	24.1	24	23.5	22.9	22	21	19.8	18.5	16.7	15									150	125	309	
NKM-G150-200/218/B/BAQE/11/4	1D8321BBX	3 x 400 V ~	11	15	22,4		13.2	13.1	13	13	12.8	12.5	12.1	11.5	11	10.4	9.7	9	8	7								150	125	280	

# NKP-G

STANDARDISED ENBLOC CENTRIFUGAL PUMPS



## NKP-G - STANDARDISED ENBLOC - 2 POLES

**CAST IRON IMPELLER**

≅ 2900 1/min

MODEL	CODE	ELECTRICAL DATA				HYDRAULIC DATA														DNA	DNM	KG	
		VOLTAGE 50 Hz	P2 NOMINAL		In (A)		Q=m³/h	0	6	12	18	24	30	36	42	48	54	60	66				72
			KW	HP	230V	400V	Q=l/min	0	100	200	300	400	500	600	700	800	900	1000	1100				1200
NKP-G 32-125.1/102/A/BAQE/0.75/2	1D1K11B3U	3 x 230 - 400 V ~	0,75	1	2,94	1,7	13	12.5	11	8										50	32	30	
NKP-G 32-125.1/115/A/BAQE/1.1/2	1D1K11B4U	3 x 230 - 400 V ~	1,1	1.5	4,16	2,4	17.2	17	15	12.5										50	32	31	
NKP-G 32-125.1/125/A/BAQE/1.5/2	1D1K11B5U	3 x 230 - 400 V ~	1,5	2	5,20	3	21	20.8	19	16.8										50	32	33	
NKP-G 32-125.1/140/A/BAQE/2.2/2	1D1K11B6U	3 x 230 - 400 V ~	2,2	3	7,97	4,6	27	26.9	25.9	23	19.5									50	32	34	
NKP-G 32-125/110/A/BAQE/1.1/2	1D1K11B3U	3 x 230 - 400 V ~	1,1	1.5	4,16	2,4	15.8	15.2	14.5	12.9	9.9									50	32	28	
NKP-G 32-125/120/A/BAQE/1.5/2	1D1K11B4U	3 x 230 - 400 V ~	1,5	2	5,20	3	19.3	18.9	18.2	16.8	14.5									50	32	32	
NKP-G 32-125/130/A/BAQE/2.2/2	1D1K11B5U	3 x 230 - 400 V ~	2,2	3	7,97	4,6	23.6	23.1	23	21.6	19.6	16.8								50	32	34	
NKP-G 32-125/142/A/BAQE/3/2	1D1K11B6U	3 x 400 V ~	3,0	4	-	5,6	28.6	28	27.6	26.5	24.6	21.8	17.9							50	32	48	
NKP-G 32-160.1 155/A/BAQE/2.2/2	1D1L11B6U	3 x 230 - 400 V ~	2,2	3	7,97	4,6	31.7	32.4	31	26.7										50	32	35	
NKP-G 32-160.1 166/A/BAQE/3/2	1D1L11B7V	3 x 400 V ~	3,0	4	-	5,6	36.7	37.3	36.3	32.8	27									50	32	42	
NKP-G 32-160.1 177/A/BAQE/4/2	1D1L11B8V	3 x 400 V ~	4	5,5	-	8,2	42.7	43.4	42.6	38.5	33.9									50	32	59	
NKP-G 32-160/151/A/BAQE/3/2	1D1211B7V	3 x 400 V ~	3,0	4	-	5,6	30.5	30	29	27	24	19.5								50	32	45	
NKP-G 32-160/163/A/BAQE/4/2	1D1211B8V	3 x 400 V ~	4,0	5,5	-	8,2	36.2	36	35	33.5	30.5	27	22							50	32	32	
NKP-G 32-160/177/A/BAQE/5,5/2	1D1211B9V	3 x 400 V ~	5,5	7,5	-	10,2	43.5	43.2	42.6	41.5	39	36	31.5	25.5						50	32	51	
NKP-G 32-200.1 188/A/BAQE/4/2	1D1M11B8V	3 x 400 V ~	4,0	5,5	-	8,2	45.3	44.4	40.8	34.4	26.8									50	32	38	
NKP-G 32-200.1 205/A/BAQE/5,5/2	1D1M11B9V	3 x 400 V ~	5,5	7,5	-	10,2	56.6	55.7	52	45.8	36.2									50	32	54	
NKP-G 32-200/190/A/BAQE/5.5/2	1D1311B9V	3 x 400 V ~	5,5	7,5	-	10,2	46.9	46.5	45	43	40	35	29							50	32	57	
NKP-G 32-200/210/A/BAQE/7.5/2	1D1311BAV	3 x 400 V ~	7,5	10	-	14,4	58.8	58	57	56	53	49	44							50	32	96	
NKP-G 40-125/107/A/BAQE/1.5/2	1D2111B5U	3 x 230 - 400 V ~	1,5	2	5,20	3	14.7	14.5	14.3	13.8	13	11.8	10.5	8.6	7					65	40	34	
NKP-G 40-125/120/A/BAQE/2.2/2	1D2111B6U	3 x 230 - 400 V ~	2,2	3	7,97	4,6	19	18.7	18.4	17.8	17	15.9	14.6	13	11					65	40	36	
NKP-G 40-125/130/A/BAQE/3/2	1D2111B7V	3 x 400 V ~	3,0	4	-	5,6	22.8	22.5	22.3	22	21.2	20.2	19	17.4	15.5	13.5				65	40	47	
NKP-G 40-125/139/A/BAQE/4/2	1D2111B8V	3 x 400 V ~	4,0	5,5	-	8,2	26.4	26.2	26	25.6	25	24	23	21.5	19.5	17.5	15			65	40	35	
NKP-G 40-160/158/A/BAQE/5,5/2	1D2211B9V	3 x 400 V ~	5,5	7,5	-	10,2	33.7			34	33.4	32.4	31	29.5	27	24				65	40	51	
NKP-G 40-160/172/A/BAQE/7,5/2	1D2211BAV	3 x 400 V ~	7,5	10	-	14,4	40.7			40.2	40.1	39.8	38.5	37.5	35.5	33	30	26.5		65	40	90	
NKP-G 40-200/210/A/BAQE/11/2	1D2311BBV	3 x 400 V ~	11,0	15	-	19,7	57.1	57	57	56.8	56.5	56	55	53	50	47	43.5	39		65	40	170	
NKP-G 40-250/230/A/BAQE/15/2	1D2411BCV	3 x 400 V ~	15,0	20	-	26,7	72.5			72.5	72	70	68	66	62.5	60	56	51.5		65	40	180	
NKP-G 40-250/245/A/BAQE/18.5/2	1D2411BDV	3 x 400 V ~	18,5	25	-	33	83			83	82.5	81.5	80	77	74	71.5	67.5	63.5	58.5	65	40	192	
NKP-G 40-250/260/A/BAQE/22/2	1D2411BEV	3 x 400 V ~	22,0	30	-	38,1	96			95	94.5	93.5	92	90	87.5	84	81	76.5	71.5	65	40	223	

# NKP-G

STANDARDISED ENBLOC CENTRIFUGAL PUMPS



## NKP-G - STANDARDISED ENBLOC - 2 POLES

CAST IRON IMPELLER

≅ 2900 1/min

MODEL	CODE	ELECTRICAL DATA				HYDRAULIC DATA																				DNA	DNM	KG	
		VOLTAGE 50 Hz		P2 NOMINAL		In A	Q=m³/h																						
		kW	HP	0	24		30	36	42	48	54	60	66	72	78	84	90	102	114	120	150								
Q=l/min		0	400	500	600	700	800	900	1000	1100	1200	1300	1400	1500	1700	1900	2000	2500											
NKP-G 50-125/115/A/ BAQE/3/2	1D3111B7V	3 x 400 V ~	3,0	4	5,6	17	16.5	16	15.5	15	14.5	13.7	13	12	11	10	9									65	50	48	
NKP-G 50-125/125/A/ BAQE/4/2	1D3111B8V	3 x 400 V ~	4,0	5.5	8,2	20.5	20	19.5	19.1	18.5	18	17.5	16.5	15.8	14.8	14	12.5	11.5									65	50	42
NKP-G 50-125/135/A/ BAQE/5,5/2	1D3111B9V	3 x 400 V ~	5,5	7.5	10,2	24	23.6	23.5	23.2	22.8	22.2	21.5	21	20	19.1	18.5	17.5	16.5	13.4								65	50	53
NKP-G 50-125/144/A/ BAQE/7,5/2	1D3111BAV	3 x 400 V ~	7,5	10	14,4	28	27.8	27.5	27.3	27	26.5	25.8	25.3	24.5	23.5	23	21.5	20.5	18	15.5							65	50	87
NKP-G 50-160/153/A/ BAQE/7,5/2	1D3211BAV	3 x 400 V ~	7,5	10	14,4	31.9	31.5	31.5	31.5	31.2	31	30.5	29.5	28.5	27.5	26	25	23.5									65	50	64
NKP-G 50-160/169/A/ BAQE/11/2	1D3211BBV	3 x 400 V ~	11,0	15	19,7	39.6		39.5	39.3	39.1	39	38.5	38	37.2	36.5	35	34	32.5									65	50	96
NKP-G 50-200/200/A/ BAQE/15/2	1D3311BCV	3 x 400 V ~	15,0	20	26,7	55.1		54.7	54.6	54	53.5	52	51	49	47.5	45.5	43	41									65	50	176
NKP-G 50-200/210/A/ BAQE/18,5/2	1D3311BDV	3 x 400 V ~	18,5	25	33	61.7		61.7	61.6	61.5	60.5	59	58	56.5	55	53	51	48.5	43								65	50	187
NKP-G 50-200/219/A/ BAQE/22/2	1D3311BEV	3 x 400 V ~	22,0	30	38,1	67.7		67.5	67.4	66.5	66	65.5	64	62.5	61	59.5	57	55	50								65	50	218
NKP-G 50-250/230/A/ BAQE/22/2	1D3411BEV	3 x 400 V ~	22,0	30	38,1	73.6		73.2	73.1	72.8	72	71	68.5	67	65	62.5	60	57	49								65	50	223
NKP-G 50-250/257/A/ BAQE/30/2	1D3411BFV	3 x 400 V ~	30,0	40	52,1	93		92.5	92.3	92	91.5	91	89	87.5	86	83	81	78	72								65	50	351
NKP-G 65-125/120-110/A/ BAQE/4/2	1D4111B8V	3 x 400 V ~	4,0	5.5	8,2	16			15	14.6	14.2	13.7	13.3	12.8	12.3	12	11.4	10	8.5	8						80	65	40	
NKP-G 65-125/127/A/ BAQE/5,5/2	1D4111B9V	3 x 400 V ~	5,5	7.5	10,2	19.5			19	18.9	18.7	18.4	18.1	17.5	17.2	16.9	16.5	15.8	14.5	13	12					80	65	55	
NKP-G 65-125/137/A/ BAQE/7,5/2	1D4111BAV	3 x 400 V ~	7,5	10	14,4	23.5			23.1	23	22.8	22.6	22.5	22	21.6	21.1	20.7	20.2	19	17.5	14.8	12				80	65	94	
NKP-G 65-160/157/A/ BAQE/11/2	1D4211BBV	3 x 400 V ~	11,0	15	19,7	32.5					32.3	32	31.9	31.3	30.2	30	29.2	28.7	27	24.8	23.6					80	65	166	
NKP-G 65-160/173/A/ BAQE/15/2	1D4211BCV	3 x 400 V ~	15,0	20	26,7	40.1					39.7	39.6	39.5	39.5	39	38.5	38.2	37.5	36	34.5	33.5	26.9				80	65	172	
NKP-G 65-200/190/A/ BAQE/18,5/2	1D4311BDV	3 x 400 V ~	18,5	25	33	51.1					51	50.8	50.5	50	49	48.5	48	47.5	45	42.5	41					80	65	192	
NKP-G 65-200/200/A/ BAQE/22/2	1D4311BEV	3 x 400 V ~	22,0	30	38,1	56.4					56.1	56.1	56	55.8	55.5	55	54.8	54.5	53	51	49					80	65	223	
NKP-G 65-200/219/A/ BAQE/30/2	1D4311BFV	3 x 400 V ~	30,0	40	52,1	68.9					68.8	68.8	68.7	68.7	68.6	68.5	68.4	67.5	66	64	63.1	57				80	65	351	

MODEL	CODE	ELECTRICAL DATA				HYDRAULIC DATA														DNA	DNM	KG						
		VOLTAGE 50 Hz		P2 NOMINAL		In A	Q=m³/h																					
		kW	HP	0	90		102	114	120	150	180	210	240															
Q=l/min		0	1500	1700	1900	2000	2500	3000	3500	4000																		
NKP-G 80-160/147-127/A/ BAQE/11/2	1D5211BBV	3 x 400 V ~	11,0	15	19,7		24	22	21.4	20.4	20	17.4	16.8	12												100	80	179
NKP-G 80-160/153/A/ BAQE/15/2	1D5211BCV	3 x 400 V ~	15,0	20	26,7		30.5	29	28.4	27.5	27	24.5	21.3	18.3												100	80	181
NKP-G 80-160/163/A/ BAQE/18,5/2	1D5211BDV	3 x 400 V ~	18,5	25	33		35.5	34.3	33.6	32.6	32.3	29.8	26.8	23.6	20											100	80	192
NKP-G 80-160/169/A/ BAQE/22/2	1D5211BEV	3 x 400 V ~	22,0	30	38,1		38.5	37.2	36.8	36	35.8	33.5	30.8	27.5	24											100	80	221
NKP-G 80-200/190/A/ BAQE/30/2	1D5311BFV	3 x 400 V ~	30,0	40	52,1		48.3	47.9	47.6	47.5	47.3	44.7	41	36	29											100	80	374

# NKP-G

STANDARDISED ENBLOC CENTRIFUGAL PUMPS



## NKP-G - STANDARDISED ENBLOC - 2 POLES

**BRONZE IMPELLER**
 $\approx 2900 \text{ 1/min}$ 

MODEL	CODE	ELECTRICAL DATA					HYDRAULIC DATA																DNA	DNM	KG
		VOLTAGE 50 Hz	P2 NOMINAL		In (A)		Q=m³/h Q=l/min	0	6	12	18	24	30	36	42	48	54	60	66	72					
			kW	HP	230V	400V		0	100	200	300	400	500	600	700	800	900	1000	1100	1200					
NKP-G 32-125.1/102/B/ BAQE/0.75/2	1D1K21B3U	3 x 230 - 400 V ~	0,75	1	2,94	1,7		13	12.5	11	8											50	32	30	
NKP-G 32-125.1/115/B/ BAQE/1.1/2	1D1K21B4U	3 x 230 - 400 V ~	1,1	1.5	4,16	2,4		17.2	17	15	12.5											50	32	31	
NKP-G 32-125.1/125/B/ BAQE/1.5/2	1D1K21B5U	3 x 230 - 400 V ~	1,5	2	5,20	3		21	20.8	19	16.8											50	32	33	
NKP-G 32-125.1/140/B/ BAQE/2.2/2	1D1K21B6U	3 x 230 - 400 V ~	2,2	3	7,97	4,6		27	26.9	25.9	23	19.5										50	32	34	
NKP-G 32-125/110/B/ BAQE/1.1/2	1D1121B4U	3 x 230 - 400 V ~	1,1	1.5	4,16	2,4		15.8	15.2	14.5	12.9	9.9										50	32	28	
NKP-G 32-125/120/B/ BAQE/1.5/2	1D1121B5U	3 x 230 - 400 V ~	1,5	2	5,20	3		19.3	18.9	18.2	16.8	14.5										50	32	32	
NKP-G 32-125/130/B/ BAQE/2.2/2	1D1121B6U	3 x 230 - 400 V ~	2,2	3	7,97	4,6		23.6	23.1	23	21.6	19.6	16.8									50	32	34	
NKP-G 32-125/142/B/ BAQE/3/2	1D1121B7V	3 x 400 V ~	3,0	4	-	5,6		28.6	28	27.6	26.5	24.6	21.8	17.9								50	32	48	
NKP-G 32-160.1 155/B/ BAQE/2.2/2	1D1L21B6U	3 x 230 - 400 V ~	2,2	3	7,97	4,6		29.2	29	26.5	20.5											50	32	35	
NKP-G 32-160.1 166/B/ BAQE/3/2	1D1L21B7V	3 x 400 V ~	3,0	4	-	5,6		35.3	35	33	28											50	32	42	
NKP-G 32-160.1 177/B/ BAQE/4/2	1D1L21B8V	3 x 400 V ~	4	5,5	-	8,2		42.7	43.4	42.6	38.5	33.9										50	32	59	
NKP-G 32-160/151/B/ BAQE/3/2	1D1221B7V	3 x 400 V ~	3,0	4	-	5,6		30.5	30	29	27	24	19.5									50	32	45	
NKP-G 32-160/163/B/ BAQE/4/2	1D1221B8V	3 x 400 V ~	4,0	5,5	-	8,2		36.2	36	35	33.5	30.5	27	22								50	32	32	
NKP-G 32-160/177/B/ BAQE/5,5/2	1D1221B9V	3 x 400 V ~	5,5	7,5	-	10,2		43.5	43.2	42.6	41.5	39	36	31.5	25.5							50	32	51	
NKP-G 32-200.1 188/B/ BAQE/4/2	1D1M21B8V	3 x 400 V ~	4,0	5,5	-	8,2		45.3	44.4	40.8	34.4	26.8										50	32	38	
NKP-G 32-200.1 205/B/ BAQE/5,5/2	1D1M21B9V	3 x 400 V ~	5,5	7,5	-	10,2		56.6	55.7	52	45.8	36.2										50	32	54	
NKP-G 32-200/190/B/ BAQE/5.5/2	1D1321B9V	3 x 400 V ~	5,5	7,5	-	10,2		46.9	46.5	45	43	40	35	29								50	32	57	
NKP-G 32-200/210/B/ BAQE/7.5/2	1D1321BAV	3 x 400 V ~	7,5	10	-	14,4		58.8	58	57	56	53	49	44								50	32	96	
NKP-G 40-125/107/B/ BAQE/1.5/2	1D2121B5U	3 x 230 - 400 V ~	1,5	2	5,20	3		14.7	14.5	14.3	13.8	13	11.8	10.5	8.6	7						65	40	34	
NKP-G 40-125/120/B/ BAQE/2.2/2	1D2121B6U	3 x 230 - 400 V ~	2,2	3	7,97	4,6		19	18.7	18.4	17.8	17	15.9	14.6	13	11						65	40	36	
NKP-G 40-125/130/B/ BAQE/3/2	1D2121B7V	3 x 400 V ~	3,0	4	-	5,6		22.8	22.5	22.3	22	21.2	20.2	19	17.4	15.5	13.5					65	40	47	
NKP-G 40-125/139/B/ BAQE/4/2	1D2121B8V	3 x 400 V ~	4,0	5,5	-	8,2		26.4	26.2	26	25.6	25	24	23	21.5	19.5	17.5	15				65	40	35	
NKP-G 40-160/158/B/ BAQE/5,5/2	1D2221B9V	3 x 400 V ~	5,5	7,5	-	10,2		33.7			34	33.4	32.4	31	29.5	27	24					65	40	51	
NKP-G 40-160/172/B/ BAQE/7,5/2	1D2221BAV	3 x 400 V ~	7,5	10	-	14,4		40.7			40.2	40.1	39.8	38.5	37.5	35.5	33	30	26.5			65	40	90	
NKP-G 40-200/210/B/ BAQE/11/2	1D2321BBV	3 x 400 V ~	11,0	15	-	19,7		57.1	57	57	56.8	56.5	56	55	53	50	47	43.5	39			65	40	170	
NKP-G 40-250/230/B/ BAQE/15/2	1D2421BCV	3 x 400 V ~	15,0	20	-	26,7		72.5			72.5	72	70	68	66	62.5	60	56	51.5			65	40	180	
NKP-G 40-250/245/B/ BAQE/18.5/2	1D2421BDV	3 x 400 V ~	18,5	25	-	33		83			83	82.5	81.5	80	77	74	71.5	67.5	63.5	58.5		65	40	192	
NKP-G 40-250/260/B/ BAQE/22/2	1D2421BEV	3 x 400 V ~	22,0	30	-	38,1		96			95	94.5	93.5	92	90	87.5	84	81	76.5	71.5		65	40	223	

H  
(m)



# NKP-G

STANDARDISED ENBLOC CENTRIFUGAL PUMPS



## NKP-G - STANDARDISED ENBLOC - 2 POLES

**BRONZE IMPELLER**

≅ 2900 1/min

MODEL	CODE	ELECTRICAL DATA				HYDRAULIC DATA																			DNA	DNM	KG
		VOLTAGE 50 Hz	P2 NOMINAL		In A	Q=m³/h Q=l/min	0	24	30	36	42	48	54	60	66	72	78	84	90	102	114	120	150				
			kW	HP			0	400	500	600	700	800	900	1000	1100	1200	1300	1400	1500	1700	1900	2000	2500				
NKP-G 50-125/115/B/BAQE/3/2	1D3121B7V	3 x 400 V ~	3,0	4	5,6	H (m)	17	16.5	16	15.5	15	14.5	13.7	13	12	11	10	9						65	50	48	
NKP-G 50-125/125/B/BAQE/4/2	1D3121B8V	3 x 400 V ~	4,0	5.5	8,2		20.5	20	19.5	19.1	18.5	18	17.5	16.5	15.8	14.8	14	12.5	11.5						65	50	42
NKP-G 50-125/135/B/BAQE/5,5/2	1D3121B9V	3 x 400 V ~	5,5	7.5	10,2		24	23.6	23.5	23.2	22.8	22.2	21.5	21	20	19.1	18.5	17.5	16.5	13.4					65	50	53
NKP-G 50-125/144/B/BAQE/7,5/2	1D3121BAV	3 x 400 V ~	7,5	10	14,4		28	27.8	27.5	27.3	27	26.5	25.8	25.3	24.5	23.5	23	21.5	20.5	18	15.5				65	50	87
NKP-G 50-160/153/B/BAQE/7,5/2	1D3221BAV	3 x 400 V ~	7,5	10	14,4		31.9	31.5	31.5	31.5	31.2	31	30.5	29.5	28.5	27.5	26	25	23.5						65	50	64
NKP-G 50-160/169/B/BAQE/11/2	1D3221BBV	3 x 400 V ~	11,0	15	19,7		39.6		39.5	39.3	39.1	39	38.5	38	37.2	36.5	35	34	32.5						65	50	96
NKP-G 50-200/200/B/BAQE/15/2	1D3321BCV	3 x 400 V ~	15,0	20	26,7		55.1		54.7	54.6	54	53.5	52	51	49	47.5	45.5	43	41						65	50	176
NKP-G 50-200/210/B/BAQE/18,5/2	1D3321BDV	3 x 400 V ~	18,5	25	33		61.7		61.7	61.6	61.5	60.5	59	58	56.5	55	53	51	48.5	43					65	50	187
NKP-G 50-200/219/B/BAQE/22/2	1D3321BEV	3 x 400 V ~	22,0	30	38,1		67.7		67.5	67.4	66.5	66	65.5	64	62.5	61	59.5	57	55	50					65	50	218
NKP-G 50-250/230/B/BAQE/22/2	1D3421BEV	3 x 400 V ~	22,0	30	38,1		73.6		73.2	73.1	72.8	72	71	68.5	67	65	62.5	60	57	49					65	50	223
NKP-G 50-250/257/B/BAQE/30/2	1D3421BFV	3 x 400 V ~	30,0	40	52,1		93		92.5	92.3	92	91.5	91	89	87.5	86	83	81	78	72					65	50	351
NKP-G 65-125/120-110/B/BAQE/4/2	1D4121B8V	3 x 400 V ~	4,0	5.5	8,2		16			15	14.6	14.2	13.7	13.3	12.8	12.3	12	11.4	10	8.5	8			80	65	40	
NKP-G 65-125/127/B/BAQE/5,5/2	1D4121B9V	3 x 400 V ~	5,5	7.5	10,2		19.5			19	18.9	18.7	18.4	18.1	17.5	17.2	16.9	16.5	15.8	14.5	13	12		80	65	55	
NKP-G 65-125/137/B/BAQE/7,5/2	1D4121BAV	3 x 400 V ~	7,5	10	14,4		23.5			23.1	23	22.8	22.6	22.5	22	21.6	21.1	20.7	20.2	19	17.5	14.8	12	80	65	94	
NKP-G 65-160/157/B/BAQE/11/2	1D4221BBV	3 x 400 V ~	11,0	15	19,7		32.5					32.3	32	31.9	31.3	30.2	30	29.2	28.7	27	24.8	23.6		80	65	166	
NKP-G 65-160/173/B/BAQE/15/2	1D4221BCV	3 x 400 V ~	15,0	20	26,7		40.1					39.7	39.6	39.5	39.5	39	38.5	38.2	37.5	36	34.5	33.5	26.9	80	65	172	
NKP-G 65-200/190/B/BAQE/18,5/2	1D4321BDV	3 x 400 V ~	18,5	25	33	51.1					51	50.8	50.5	50	49	48.5	48	47.5	45	42.5	41		80	65	192		
NKP-G 65-200/200/B/BAQE/22/2	1D4321BEV	3 x 400 V ~	22,0	30	38,1	56.4					56.1	56.1	56	55.8	55.5	55	54.8	54.5	53	51	49		80	65	223		
NKP-G 65-200/219/B/BAQE/30/2	1D4321BFV	3 x 400 V ~	30,0	40	52,1	68.9					68.8	68.8	68.7	68.7	68.6	68.5	68.4	67.5	66	64	63.1	57	80	65	351		

MODEL	CODE	ELECTRICAL DATA				HYDRAULIC DATA												DNA	DNM	KG	
		VOLTAGE 50 Hz	P2 NOMINAL		In A	Q=m³/h Q=l/min	0	90	102	114	120	150	180	210	240						
			kW	HP			0	1500	1700	1900	2000	2500	3000	3500	4000						
NKP-G 80-160/147-127/BAQE/11/2	1D5221BBV	3 x 400 V ~	11,0	15	19,7	H (m)	24	22	21.4	20.4	20	17.4	16.8	12					100	80	179
NKP-G 80-160/153/B/BAQE/15/2	1D5221BCV	3 x 400 V ~	15,0	20	26,7		30.5	29	28.4	27.5	27	24.5	21.3	18.3					100	80	181
NKP-G 80-160/163/B/BAQE/18,5/2	1D5221BDV	3 x 400 V ~	18,5	25	33		35.5	34.3	33.6	32.6	32.3	29.8	26.8	23.6	20				100	80	192
NKP-G 80-160/169/B/BAQE/22/2	1D5221BEV	3 x 400 V ~	22,0	30	38,1		38.5	37.2	36.8	36	35.8	33.5	30.8	27.5	24				100	80	221
NKP-G 80-200/190/B/BAQE/30/2	1D5321BFV	3 x 400 V ~	30,0	40	52,1		48.3	47.9	47.6	47.5	47.3	44.7	41	36	29				100	80	374

# NKM-G / NKP-G

STANDARDISED ENBLOC CENTRIFUGAL PUMPS



## SPECIAL VERSION

MODEL
NKM-G/NKP-G 32/125.1
NKM-G/NKP-G 32/160.1
NKM-G/NKP-G 32/200.1
NKM-G/NKP-G 32/125
NKM-G/NKP-G 32/160
NKM-G/NKP-G 32/200
NKM-G/NKP-G 40/125
NKM-G/NKP-G 40/160
NKM-G/NKP-G 40/200
NKM-G/NKP-G 40/250
NKM-G/NKP-G 50/125
NKM-G/NKP-G 50/160
NKM-G/NKP-G 50/200
NKM-G/NKP-G 50/250
NKM-G/NKP-G 65/125
NKM-G/NKP-G 65/160
NKM-G/NKP-G 65/200
NKM-G 65/250
NKM-G 65/315
NKM-G/NKP-G 80/160
NKM-G/NKP-G 80/200
NKM-G 80/250
NKM-G 80/315
NKM-G 100/200
NKM-G 100/250
NKM-G 100/315
NKM-G 125/250
NKM-G 150/200

MODEL
NKM-G / NKP-G 32/125.1
NKM-G / NKP-G 32/125
NKM-G / NKP-G 32/160.1
NKM-G / NKP-G 32/160
NKM-G / NKP-G 32/200.1
NKM-G / NKP-G 32/200
NKM-G / NKP-G 40/125
NKM-G / NKP-G 40/160
NKM-G / NKP-G 40/200
NKM-G / NKP-G 40/250
NKM-G / NKP-G 50/125
NKM-G / NKP-G 50/160
NKM-G / NKP-G 50/200
NKM-G / NKP-G 50/250
NKM-G / NKP-G 65/125
NKM-G / NKP-G 65/160
NKM-G / NKP-G 65/200
NKM-G / NKP-G 65/250
NKM-G / NKP-G 65/315
NKM-G / NKP-G 80/160
NKM-G / NKP-G 80/200
NKM-G / NKP-G 80/250
NKM-G / NKP-G 80/315
NKM-G / NKP-G 100/200
NKM-G / NKP-G 100/250
NKM-G / NKP-G 100/315
NKM-G / NKP-G 125/250
NKM-G / NKP-G 150/200

## VERSIONS WITH SPECIAL MECHANICAL SEALS

- (1) Ref. Technical catalogue mechanical seal "E version" = Silicon carbide/silicon carbide/EPDM
- (2) Ref. Technical catalogue mechanical seal "C version" = with rubber bellow: silicon carbide/silicon carbide/Viton
- (3) Ref. Technical catalogue mechanical seal "D version" = with rubber bellow: carbon/silicon carbide/Viton

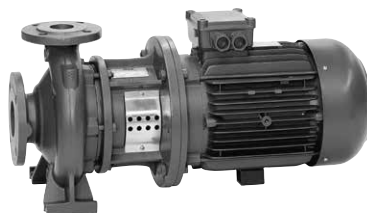

## CATAPHORESIS COATING FOR COMPONENTS IN CONTACT WITH LIQUID

FOR BRONZE IMPELLER VERSIONS

# STANDARDISED CENTRIFUGAL PUMPS - KDN

PERFORMANCE RANGE

4 POLES = 1450 1/min

MODEL	Q (m³/h)	0	12	18	24	30	36	42	48	54	60	66	72	78	84	90	102	114	
	(l/min)	0	200	300	400	500	600	700	800	900	1000	1100	1200	1300	1400	1500	1700	1900	
KDN 50-125/115	H (m)	4.2	4.1	3.9	3.6	3.3	2.9	2.3											
KDN 50-125/120		4.6	4.4	4.3	4	3.7	3.3	2.8											
KDN 50-125/125		5	4.9	4.7	4.5	4.2	3.7	3.3											
KDN 50-125/130		5.6	5.4	5.2	5	4.7	4.2	3.8	3.2										
KDN 50-125/135		6	5.8	5.7	5.5	5.2	4.8	4.3	3.8										
KDN 50-125/139		6.3	6.2	6.1	5.9	5.6	5.2	4.8	4.2										
KDN 50-125/144		6.7	6.7	6.6	6.4	6.2	5.8	5.3	4.8	4.1									
KDN 50-160/137		6	6	5.9	5.6	5.2	4.8												
KDN 50-160/145		6.8	6.7	6.7	6.5	6.2	5.8												
KDN 50-160/153		7.6	7.6	7.5	7.4	7.2	6.7												
KDN 50-160/161		8.4	8.4	8.3	8.2	8.1	7.7												
KDN 50-160/169		9.4	9.3	9.2	9.2	9.1	8.8												
KDN 50-160/177		10.4	10.3	10.3	10.2	10.1	9.95												
KDN 50-200/170		9.5	9.3	9.2	8.8	8	6.85												
KDN 50-200/180		10.6	10.6	10.5	10.1	9.5	8.6	7.3											
KDN 50-200/190		11.8	11.7	11.6	11.4	10.8	10.1	8.9											
KDN 50-200/200		13.1	13	13	12.8	12.3	11.6	10.6	9.4										
KDN 50-200/210		14.6	14.6	14.5	14.4	13.9	13.2	12.2	11										
KDN 50-200/219		16	16	16	15.9	15.4	14.2	13.8	12.7	11.4									
KDN 50-250/220		15.9	15.7	15.6	15.4	14.9	13.8	12.4	10.5										
KDN 50-250/230		17.4	17.3	17.2	17	16.5	15.5	14.2	12.6	10.3									
KDN 50-250/240		19	19	19	18.8	18.2	17.4	16.2	14.7	12.4									
KDN 50-250/250		20.8	20.8	20.7	20.6	20.1	19.2	18.1	17	14.8									
KDN 50-250/263		23	23	22.9	22.8	22.5	21.7	20.6	19.4	17.5									
KDN 65-125/120/110		3.75			3.5	3.3	3.2	2.9	2.7	2.3	1.9								
KDN 65-125/120		4.25			3.9	3.8	3.6	3.3	3.1	2.7	2.3								
KDN 65-125/125		4.7			4.4	4.25	4.1	3.8	3.6	3.25	2.8								
KDN 65-125/130		5.1			4.9	4.75	4.6	4.3	4.1	3.8	3.3	2.8							
KDN 65-125/135		5.6			5.4	5.3	5.2	4.9	4.7	4.3	3.9	3.5	3						
KDN 65-125/140		6			5.9	5.8	5.7	5.5	5.2	4.9	4.5	4.1	3.6						
KDN 65-125/144		6.4			6.35	6.25	6.2	5.9	5.7	5.4	5	4.65	4.2	3.7					
KDN 65-160/137		5.8			5.7	5.4	5.2	4.75	4.3	3.7									
KDN 65-160/145		6.5			6.5	6.3	6	5.7	5.3	4.75	4.1								
KDN 65-160/153		7.3			7.2	7.2	6.9	6.7	6.3	5.8	5.25								
KDN 65-160/161		8.2			8.1	8.1	7.9	7.7	7.3	6.85	6.3	5.8							
KDN 65-160/169		9.1			9.1	9	8.9	8.7	8.4	8	7.6	7.1	6.4						
KDN 65-160/177		10			10	9.9	9.8	9.7	9.45	9.1	8.7	8.2	7.5						
KDN 65-200/170		9.3		9.3	9.2	9.2	9	8.5	7.9	7.1	6.3								
KDN 65-200/180		10.4		10.4	10.4	10.3	10.2	10	9.5	8.8	8.1								
KDN 65-200/190		12.1		12	12	12	11.9	11.5	11.1	10.5	9.8	8.8							
KDN 65-200/200		13.3		13.3	13.3	13.2	13.1	13	12.8	12.3	11.6	10.8							
KDN 65-200/210		14.8		14.7	14.7	14.7	14.6	14.6	14.3	13.8	13.4	12.7	12						
KDN 65-200/219		16.2		16.2	16.2	16.1	16	15.9	15.8	15.4	15	14.4	13.5	12.7					
KDN 65-250/220		15.8			15.8	15.5	15.1	14.5	14	13.2	12	10.7							
KDN 65-250/230		17.4			17.4	17.2	16.8	16.3	15.7	15	14.1	12.7	11.4						
KDN 65-250/240	19			19	18.9	18.5	18.1	17.5	16.8	16	14.7	13.6							
KDN 65-250/250	20.7			20.7	20.6	20.4	20	19.5	18.8	18	17	15.9	14.5						
KDN 65-250/263	23.2			23	23	22.9	22.5	22.2	21.6	20.8	19.8	18.6	17.4	16					
KDN 65-315/260	22.3			22.2	22.1	22	21.5	21	20.5	20	19.2	18.4	17	16	15				
KDN 65-315/275	25.1			25.1	25	24.8	24.6	24.1	23.5	23	22.5	21.5	20.5	19.4	18.1				
KDN 65-315/290	28.2			28.2	28.1	28	27.8	27.3	27	26.5	25.5	25	24	23.1	22	19.5			
KDN 65-315/305	31.7			31.5	31.4	31.4	31.3	31.2	30.8	30.4	29.6	29	28	27.2	26.1	23.5			
KDN 65-315/320	35.7			35.4	35.3	35.2	35.1	35	34.8	34.5	33.8	33.5	32.5	31.5	30.8	28	24.8		

# STANDARDISED CENTRIFUGAL PUMPS - KDN

PERFORMANCE RANGE

4 POLES = 1450 1/min

MODEL	Q (m³/h)		H (m)																							
	0	(l/min)	0	42	48	54	60	66	72	78	84	90	102	114	120	150	180	210	240	270	300	330	360	390	420	
KDN 80-160/147/127	5.7	5.4	5.25	5.05	4.8	4.6	4.35	4.15	3.85	3.6	3.1	2.5	2.2													
KDN 80-160/153/136	6.4	6.2	6.05	5.85	5.7	5.4	5.15	4.8	4.65	4.4	3.85	3.3	3													
KDN 80-160/153	7.3	7.1	6.9	6.7	6.5	6.3	6	5.75	5.4	5.2	4.55	3.9	3.6													
KDN 80-160/161	8.2	8	7.9	7.75	7.5	7.3	7.05	6.8	6.5	6.25	5.6	4.9	4.6													
KDN 80-160/169	9.1	9	8.85	8.7	8.6	8.35	8.1	7.85	7.6	7.3	6.75	6	5.7													
KDN 80-160/177	10	9.9	9.85	9.8	9.7	9.5	9.3	9.1	8.85	8.7	8.1	7.25	6.9													
KDN 80-200/170	9.2	9.1	9	8.7	8.5	8.2	7.8	7.5	7.1	6.7	5.6															
KDN 80-200/180	10.3	10.2	10.2	10	9.9	9.6	9.2	9	8.6	8.2	7.2															
KDN 80-200/190	11.4	11.4	11.3	11.2	11.1	11	10.7	10.5	10.1	9.8	8.7	6.8														
KDN 80-200/200	12.7	12.6	12.6	12.6	12.5	12.4	12.3	12	11.6	11.4	10.5	9.4	8.8													
KDN 80-200/210	14.1	14	14	14	13.9	13.8	13.7	13.6	13.3	13.1	12.1	11.2	10.6													
KDN 80-200/222	15.9	15.9	15.8	15.7	15.6	15.6	15.5	15.4	15.3	15	14.3	13.4	12.8													
KDN 80-250/220	16	15.9	15.8	15.7	15.6	15.5	15.2	14.9	14.5	13.9	12.8															
KDN 80-250/230	17.3	17.3	17.2	17.1	17	16.9	16.8	16.5	16	15.5	14.3	12.4														
KDN 80-250/240	19	19	19	18.9	18.8	18.7	18.6	18.4	18	17.6	16.6	15.3	14.6													
KDN 80-250/250	20.8	20.7	20.7	20.7	20.6	20.5	20.4	20.3	19.9	19.6	18.6	17.4	16.8													
KDN 80-250/260	22.6	22.5	22.5	22.4	22.3	22.2	22.1	22	21.8	21.4	20.6	19.6	19	15.1												
KDN 80-250/270	24.5	24.4	24.4	24.4	24.3	24.2	24.1	24	23.7	23.3	22.4	21.4	20.7	16.3												
KDN 80-315/275	24.8		24.8	24.8	24.7	24.6	24.5	24.4	24.3	24	23	21.4	20.5													
KDN 80-315/290	27.8		27.8	27.8	27.7	27.7	27.6	27.6	27.5	27.4	26.5	25	24.6	19.1												
KDN 80-315/305	31.4		31.4	31.3	31.2	31.2	31.2	31.2	31.2	30.9	30	29	28.5	24												
KDN 80-315/320	34.8		34.7	34.6	34.6	34.5	34.4	34.3	34	33.9	33.8	33.2	32.8	28.8												
KDN 80-315/334	38.3		38.2	38.2	38.2	38.2	38.2	38.1	38	37.9	37.6	37	36.9	33.1	28											
KDN 100-200/180	10.1				10.1	10.1	10	9.9	9.7	9.5	9.1	8.5	8.3	7	5.4											
KDN 100-200/190	11.6				11.5	11.4	11.3	11.2	11.1	11	10.5	10.1	10	8.6	7											
KDN 100-200/200	12.9				12.8	12.8	12.8	12.7	12.6	12.5	12.2	11.8	11.6	10.4	8.8											
KDN 100-200/210	14.3				14.2	14.2	14.2	14.2	14.1	14	13.8	13.5	13.3	12.3	10.7	9										
KDN 100-200/219	16				15.7	15.7	15.6	15.6	15.5	15.5	15.3	15.1	15	14	12.5	10.8										
KDN 100-250/220	15.2				14.9	14.9	14.9	14.8	14.7	14.6	14.3	13.7	13.4	11.4												
KDN 100-250/230	16.9				16.7	16.7	16.6	16.5	16.4	16.3	16.1	15.7	15.3	13.6	11.1											
KDN 100-250/240	18.5				18.3	18.3	18.3	18.2	18.1	18	17.9	17.6	17.4	15.7	13.3											
KDN 100-250/250	20.1				20	20	19.9	19.8	19.7	19.6	19.5	19.4	19.2	17.6	15.4											
KDN 100-250/260	22.3				22.1	22.1	22.1	22	21.9	21.8	21.7	21.5	21.4	19.8	17.7	15.1										
KDN 100-250/270	24.3				24.3	24.3	24.3	24.3	24.3	24.2	24.1	23.7	23.5	22.1	20.1	17.3										
KDN 100-315/275	25.1				25	25	25	24.9	24.8	24.7	24.6	24.4	24	22	19											
KDN 100-315/290	28				27.9	27.9	27.9	27.9	27.8	27.7	27.6	27.5	27	25.5	23											
KDN 100-315/305	31.3				31.1	31.1	31.1	31	30.9	30.8	30.7	30.6	30.5	29	27	24										
KDN 100-315/320	34.5				34.4	34.4	34.4	34.4	34.4	34.3	34.2	34.1	34	33	31	28.1										
KDN 100-315/334	38.2				38.2	38.1	38.1	38.1	38	38	37.7	37.5	37.3	36.5	34.8	32	28.8									
KDN 125-250/220	15										14.9	14.9	14.8	14.5	14	13	11.8	10.5	9.2							
KDN 125-250/230	16.6										16.6	16.6	16.5	16.3	15.6	14.8	13.8	12.5	12.3	9.5						
KDN 125-250/240	18.2										18.1	18.1	18.1	18	17.7	16.8	15.8	14.5	13.3	11.6	10.1					
KDN 125-250/250	19.9										19.8	19.8	19.7	19.6	19.4	18.7	17.8	16.6	15.5	14	12.3					
KDN 125-250/260	21.7										21.7	21.6	21.5	21.4	21.3	20.6	19.9	18	17.7	16.3	14.6	13				
KDN 125-250/269	23.9										23.9	23.9	23.8	23.6	23.2	22.7	22.1	22.2	20.2	19	17.5	15.6	14			
KDN 150-200/210/170	8.9										8.9	8.9	8.8	8.7	8.6	8.3	7.9	7.4	6.8	6.2	5.4	4.5				
KDN 150-200/218/182	10.4										10.4	10.4	10.3	10.2	9.9	9.5	9.1	8.6	8.1	7.4	6.6	5.8				
KDN 150-200/218/200	11.4										11.4	11.4	11.4	11.2	10.9	10.6	10.1	9.7	9.2	8.5	7.8	6.9	5.9			
KDN 150-200/218	12.9										12.7	12.7	12.6	12.4	12.1	11.7	11.2	10.7	10.2	9.6	8.8	8	7.1			
KDN 150-200/224	13.8										13.6	13.6	13.5	13.3	13	12.6	12.2	11.7	11.2	10.6	9.9	9.2	8.2			

D+CONNECT

COMMAND AND CONTROL SYSTEMS

CIRCULATORS AND IN-LINE PUMPS

MULTISTAGE CENTRIFUGAL AND SELF-PRIMING PUMPS

SWIMMING POOL, POND AND SALT WATER PUMPS

CENTRIFUGAL PUMPS

SUBMERSIBLE PUMPS

SUBMERSIBLE PUMPS AND SUBMERSIBLE MOTORS

PRESSURE UNITS



# STANDARDISED CENTRIFUGAL PUMPS - KDN

PERFORMANCE RANGE

2 POLES = 2900 1/min

MODEL	Q (m³/h)	0	6	12	18	24	30	36	42	48	54
	(l/min)	0	100	200	300	400	500	600	700	800	900
KDN 32-125.1/105	H (m)	13.8	13.6	12.3	9.7						
KDN 32-125.1/110		15.5	15.2	13.9	11.5						
KDN 32-125.1/115		17.1	16.8	15.5	13.2						
KDN 32-125.1/120		18.8	18.5	17.3	15.1						
KDN 32-125.1/125		20.5	20.3	19.1	17						
KDN 32-125.1/130		22.3	22.2	21.3	19						
KDN 32-125.1/135		24.4	24.1	23.3	21.1	17.8					
KDN 32-125.1/140		26.5	26.4	25.6	23.4	20.1					
KDN 32-125/115		17.3		16.5	15.1	12.9					
KDN 32-125/120		19		18.2	17	14.9	11.1				
KDN 32-125/125		20.9		20.1	18.9	16.9	13.5				
KDN 32-125/130		22.9		22	21	19.1	16.2				
KDN 32-125/135		24.9		24	22.1	21.5	18.5	14.7			
KDN 32-125/142		27.8		27	26.1	24.5	21.7	18			
KDN 32-160.1/137		21.5	21.2	19.3							
KDN 32-160.1/145		24.7	24.5	22.3	16.5						
KDN 32-160.1/153		28.3	28	26	20.5						
KDN 32-160.1/161		32	31.8	30	25						
KDN 32-160.1/169		36	35.7	34.4	29.5						
KDN 32-160.1/177		39.5	39.3	38.2	34.5	26					
KDN 32-160/137		23.7		22.6	20.7	17.6					
KDN 32-160/145		27		25.8	23.9	21.2	16.9				
KDN 32-160/153		30.4		29.5	27.7	25.8	21.2				
KDN 32-160/161		34		33	31.7	29.1	25.5				
KDN 32-160/169		38		37.3	36	33.6	35.7	26.5			
KDN 32-160/177		41.8		41.5	40.5	38.4	35.3	31.4			
KDN 32-200.1/170		34.3	34.2	31.9	23.5						
KDN 32-200.1/180		39.4	39.2	36.7	30						
KDN 32-200.1/190		45.3	44.7	41.5	35.5						
KDN 32-200.1/200		51.5	51	47.3	41	35					
KDN 32-200.1/207		55.3	55	51.8	46.4	37					
KDN 32-200/170		34		33	31	27	21				
KDN 32-200/180	39		38.5	36.5	32.5	28					
KDN 32-200/190	45		43.5	42	39	34	28.5				
KDN 32-200/200	51		49	48	45	40.5	35				
KDN 32-200/210	57		56	55	52.5	48.5	43	36			
KDN 32-200/219	63		62	61	59	56.5	52.5	46.5	39.5		

D+CONNECT

COMMAND AND CONTROL SYSTEMS

CIRCULATORS AND IN-LINE PUMPS

MULTISTAGE CENTRIFUGAL AND SELF-PRIMING PUMPS

SWIMMING POOL, POND AND SALT WATER PUMPS

CENTRIFUGAL PUMPS

SUBMERSIBLE PUMPS

SUBMERSIBLE PUMPS AND SUBMERSIBLE MOTORS

PRESSURE UNITS

# STANDARDISED CENTRIFUGAL PUMPS - KDN

PERFORMANCE RANGE

2 POLES = 2900 1/min

MODEL	Q (m <sup>3</sup> /h) (l/min)	0	6	12	18	24	30	36	42	48	54	60	66	72	78	84	90	102	114	
		0	100	200	300	400	500	600	700	800	900	1000	1100	1200	1300	1400	1500	1700	1900	
KDN 40-125/115	H (m)	16.8		13.3	15.6	15	14.3	13.2	12.6	9.8										
KDN 40-125/120		18.5		18	17.5	17	16	15	13.5	11.8										
KDN 40-125/125		20.4		20	19.5	19	18	16.7	15.3	13.5										
KDN 40-125/130		22		21.8	21.5	21	20	19	17.5	15.7	14									
KDN 40-125/135		24.1		24	23.9	23.4	22.5	21.5	20	18.3	16.4									
KDN 40-125/142		26.8		26.6	26.4	26	25.3	24.4	23	21.4	19.4	17								
KDN 40-160/137		23.9			23.8	23	22	20.5	18	15										
KDN 40-160/145		27.5			27.4	27	25.7	24.2	22.1	19.5										
KDN 40-160/153		31.1			31	30.5	29.5	28	26.5	24	21									
KDN 40-160/161		34.5			34.5	34.4	33.7	32.3	30.5	28.5	25.8	22.5								
KDN 40-160/169		38.4			38.4	38.2	38	37	35	33.5	31	28								
KDN 40-160/177		42.6			42.5	42.4	42	41.5	40	38.5	35	33	30							
KDN 40-200/170		33.6			33	32.6	32	30	26.5	22.5										
KDN 40-200/180		38.8			38.5	38	37	35	32.5	29	25									
KDN 40-200/190		43.4			43.1	43	42.7	41	38	35	31.5	27								
KDN 40-200/200		48.7			48.4	48.2	47.5	46.5	44	41.5	38.5	34.5								
KDN 40-200/210		54.3			54.1	54	53.6	53	51	48.5	46	42.5	38							
KDN 40-200/219		60			59.8	59.7	59.4	59	57	55	52.5	49.5	46	40						
KDN 40-250/220		63.1			62.8	62.5	61	59	57	55	52	48								
KDN 40-250/230		69.5			69.3	68.5	67.8	66	63.5	61	58	55	51							
KDN 40-250/240		76.3			76	75.8	75	73	70.5	68	65	62	58.5							
KDN 40-250/250		82.8			82.5	82	81.8	80	78	75.5	72.5	69	66							
KDN 40-250/260		91			90.5	90	89.5	88.5	86.5	84	81	78	74							
KDN 50-125/115		17.1					15.9	15.5	15	14.3	13.6	13	12.2	11.5	10.4	9				
KDN 50-125/120		18.2					17.5	17	16.5	16	15.3	14.7	14	13.2	12	11.2	10			
KDN 50-125/125		19.8					19.4	19	18.5	17.9	17.4	16.6	16	15.1	14	13	11.8			
KDN 50-125/130	21.5					21.1	20.8	20.5	19.8	19.2	18.5	17.8	17	16.5	15.2	14				
KDN 50-125/135	23.2					23	22.6	22.3	21.8	21.2	20.6	19.9	19.3	18.4	17.5	16.3	13.7			
KDN 50-125/139	24.7					24.5	24.3	24	23.5	23	22.4	21.6	20.8	20	19.2	18	15.5			
KDN 50-125/144	25.9					26.5	26.4	26.1	25.6	25.1	24.5	24	23.2	22.3	21.5	20.5	17.8	15		
KDN 50-160/137	24.2					23.8	23.7	23.5	22.5	22	21	20.3	19	18	16.8	15				
KDN 50-160/145	27.2					27	26.9	26.6	26.4	25.5	25	23.8	23	21.5	20.5	19				
KDN 50-160/153	30.3					30.3	30.2	30	29.9	29.5	28.5	27.7	26.5	25.5	24.5	23				
KDN 50-160/161	33.8					33.7	33.7	33.6	33.6	33.3	32.5	31.8	31	29.8	28.5	27.5				
KDN 50-160/169	37.7					37.7	37.5	37.5	37.4	37	36.2	35.7	35.5	34.2	33	31.5	29			
KDN 50-160/177	41.6					41.5	41.5	41.3	41.2	41	40.6	40.5	39.5	38.8	38	36.7	33.5			
KDN 50-200/170	37.9					37	36.8	36.4	35	34	32	30	27	25						
KDN 50-200/180	42.5					42	41.7	41.4	40.5	39.5	38	36	34	32	29					
KDN 50-200/190	47.2					46.8	46.6	46	45.7	44.5	43.5	42	40	38	35.5	33				
KDN 50-200/200	52.4					52.2	52	51.8	51.5	50.5	49	47.5	46	44.5	42	40				
KDN 50-200/210	58.4					58.4	58.2	58	57.5	56.5	55.5	54	52.5	51	49	46.5	41.5			
KDN 50-200/219	64					64	64	64	63.5	62.5	61.5	60	58.5	57	55	53	48.5			
KDN 50-250/220	63.7					63.3	63.1	63	62	61	59	57.5	55	53	50	46.5	36			
KDN 50-250/230	69.6					69.3	69	68.8	68.5	68	66	64	62	60	57	54	45			
KDN 50-250/240	76					75.8	75.5	75.3	75	74.5	73	71.5	69	67	65	62	55			
KDN 50-250/250	83.2					83	82.9	82.8	83.5	82	80.5	78.5	77	75	72.5	70	64			
KDN 50-250/263	92.1					92	91.8	91.6	91.5	91.3	89.9	88.5	86.5	84.5	82.5	80	75	61		

D+CONNECT

COMMAND AND CONTROL SYSTEMS

CIRCULATORS AND IN-LINE PUMPS

MULTISTAGE CENTRIFUGAL AND SELF-PRIMING PUMPS

SWIMMING POOL, POND AND SALT WATER PUMPS

CENTRIFUGAL PUMPS

SUBMERSIBLE PUMPS

SUBMERSIBLE PUMPS AND SUBMERSIBLE MOTORS

PRESSURE UNITS



# STANDARDISED CENTRIFUGAL PUMPS - KDN

PERFORMANCE RANGE

2 POLES = 2900 1/min

MODEL	Q (m³/h) (l/min)	0	48	54	60	66	72	78	84	90	102	114	120	150	180	210	240	270	300	330	360	390	420
		0	800	900	1000	1100	1200	1300	1400	1500	1700	1900	2000	2500	3000	3500	4000	4500	5000	5500	6000	6500	7000
KDN 65-125/120/110		16	14.4	14	13.6	13.1	12.8	12.2	11.9	11.4	10.2	8.7	8										
KDN 65-125/120		17.8	16	15.8	15.3	14.9	14.4	13.9	13.4	13	11.5	10.3	9.4										
KDN 65-125/125		19.4	17.8	17.5	17.1	16.8	16.4	16	15.4	15	13.5	12.2	11.4										
KDN 65-125/130		21	19.6	19.5	19.1	18.9	18.5	18	17.5	17	15.7	14.2	13.2										
KDN 65-125/135		22.6	21.8	21.5	21.3	21	20.5	20.1	19.6	19.2	18	16.5	15.6										
KDN 65-125/140		24	23.6	23.6	23.4	23	22.8	22.3	22	21.4	20.3	18.9	18	13.8									
KDN 65-125/144		25.6	25.5	25.4	25.2	25	24.6	24.3	24	23.4	22.5	21.1	20.2	16									
KDN 65-160/137		23.1	22.4	22	21.7	21.3	20.5	19.7	19	18	16												
KDN 65-160/145		26.2	25.7	25.5	25	24.6	24	23.5	22.7	22	20	17.8	16.5										
KDN 65-160/153		29.1	28.8	28.5	28.6	28.5	28	27.5	26.6	26	24	22	21										
KDN 65-160/161		32.6	32.5	32.4	32.3	32	31.7	31.3	30.5	30	28.5	26.5	25.5										
KDN 65-160/169		36.4	36.3	36.2	36.1	36	35.7	35.3	34.7	34	32.7	31	30										
KDN 65-160/177		40.1	39.9	39.8	39.7	40	39.8	39.5	39	38.5	37.2	35.5	34.7	28.5									
KDN 65-200/170		37.2	36.8	36.7	36.6	36.5	36	35	34	32.5	30	27	25										
KDN 65-200/180		41.7	41.4	41.3	41.2	41.1	41	40.5	40	39	36.5	34	32										
KDN 65-200/190		48.3	48.2	48.1	48	47.9	47.5	47	41	45	43	40.5	39										
KDN 65-200/200		53.2	53.1	52.9	52.8	52.7	52.5	52.3	52	51.8	50	48	46.5										
KDN 65-200/210		59.2	59.1	59	58.9	58.8	58.7	58.5	58.2	58	56.5	54.5	53.5										
KDN 65-200/219		64.9	64.9	64.8	64.5	64.3	64.1	64	63.8	62.5	62.4	61	60	52.5									
KDN 65-250/220		63.2	62.8	62.5	62	61	60	59.5	58	57	54	50.5	48										
KDN 65-250/230		69.5	69.5	69	68.5	68	67	66	65	64	63	58.5	56.5										
KDN 65-250/240		76	75.7	75.5	75	75	74	73	72	71	69	66	64										
KDN 65-250/250		83	82.3	82.3	82.2	82	81.5	81	80	79	76.5	73.5	72	60									
KDN 65-250/263		92.6	91.8	91.8	91.7	91.5	91.5	91	90	89.5	87.5	85	83	72.5									
KDN 65-315/260		92.8				92.7	91.9	90.9	89.7	88.5	85.5	81.9	79.9	67.8									
KDN 65-315/275		105				104.5	103.9	103.1	102.1	101.1	98.5	95.5	93.8	83.3	69.5								
KDN 65-315/290		117.1				117.0	116.5	115.9	115.1	114.3	112.2	109.7	108.3	99.4	87.6								
KDN 65-315/305		130				129.5	129.2	128.7	128.0	127.3	125.5	123.2	121.9	113.8	103.0	89.6							
KDN 65-315/320		143				142.9	142.6	142.1	171.6	140.9	139.3	137.3	136.2	128.9	119.1	106.8	92.0						
KDN 80-160/147/127	H (m)	23								21.5	20.7	20	19.5	17	14.5	11.8	8.8						
KDN 80-160/153/136		25.6									24.5	23.8	23	22.5	20.2	17.5	15	11.8					
KDN 80-160/153	29.3									28	27.3	26.5	26	23.5	20.7	16.5	14.5						
KDN 80-160/161	32.8									32	31.5	30.5	30	27.8	25	21.5	18.5						
KDN 80-160/169	36.5									35.7	35.2	34.5	34.2	32	29.5	26.5	22.6	18.5					
KDN 80-160/177	40									39.5	39.2	38.7	38.5	37	34.8	31.8	27.8	23					
KDN 80-200/170	36.6									35.7	35.5	34.5	34	31	27	21.5							
KDN 80-200/180	41									40.6	40.5	40	39.5	37	33	27.5							
KDN 80-200/190	45.7									45.4	45	44.5	44	42	29	34							
KDN 80-200/200	50.8									50.4	50.2	50	49.6	49	46.5	41	35						
KDN 80-200/210	56.3									55.9	55.8	55.7	55.6	54.8	52	48	43						
KDN 80-200/222	63.6									63.4	63.3	63.2	63.1	63	60	56.5	51.5	45					
KDN 80-250/220	62.6									62.5	62.4	62	61.8	60	55.5	49							
KDN 80-250/230	68.3									68.2	68.1	67.9	67.9	67	63	57	50						
KDN 80-250/240	75.5									75.4	75.3	75.2	75	74.5	71	66.5	58.5						
KDN 80-250/250	82.5									82.3	82	81.9	81.7	82	78.5	74	67.5	60.5					
KDN 80-250/260	90									89.7	89.6	86.5	89.3	89	86.5	82	77	70	61.5				
KDN 80-250/270	97.9									97.8	97.5	91.3	97	96.3	94	89	84	77	69				
KDN 80-315/275	106									106.1	105.3	104.3	103.7	99.4	93.4	85.6	76.0						
KDN 80-315/290	118									118.4	117.8	117.1	116.6	113.2	108.2	101.5	93.2	83.4					
KDN 100-200/180	40.4													40	38	36	33	30.5	28	25			
KDN 100-200/190	46.5													45	44	42	39	37	34.5	31	28		
KDN 100-200/200	51.5													51	50	48.5	46	44	42	39	35	31.5	
KDN 100-200/210	57.5													57	56	55	53	51	49	46	43	39	36
KDN 100-200/219	64													62.5	62	61	60	58	56	53	50	47	43
KDN 100-250/220	61.1													60	59.5	57	54	50.5	46.5	42			
KDN 100-250/230	67.4													66.9	66.5	64	61	58	54	49	44		
KDN 100-250/240	73.5													72.9	71	70.5	69	66	63	58.5	53		
KDN 100-250/250	79.7													79.5	79	78.8	77	74	71	67	62.5		
KDN 100-250/260	88.6													88.2	88.1	88	86	83	79.5	76	71.5	66	



Enbloc, centrifugal electric pumps with coupling designed for a wide range of applications such as:

- Supplying water.
- The circulation of hot water for central heating.
- The circulation of cold water for air conditioning and refrigerating.
- The transfer of liquids in agriculture, horticulture and industries.
- The implementation of pumping systems.

These can be connected to a two or four poles electric motor with a coupling and mounted on a pressed metal bedplate in accordance with UNI EN 23661.

Single-stage, cast iron spiral body made to DIN-EN 733 (formerly DIN 24255), cast iron seal holder cover and motor support, flanges in accordance with DIN 2533 (DIN 2532 for DN 200).

Impeller in cast iron, encased and dynamically balanced with compensation of the axial thrust by means of balancing holes, operating (on request) with interchangeable consumable rings.

Stainless steel pump shaft supported by two large maintenance-free greased ball bearings, housed inside a special chamber of the support. Standard seal: standardised mechanical seal made to DIN 24960 in carbon/carborundum with O' rings in EPDM. Packing on request with hydraulic lubricating ring and stuffing box in two easily removable parts.

**Speed of rotation** 1450 - 2900 1/min.

**Operating range**

from 1 to 500 m<sup>3</sup>/h with a head of up to 100 metres.

**Pumped liquid** clean, without solid or abrasive substances, not viscous, not aggressive, not crystallised and chemically neutral, close to water characteristics.

**Liquid temperature range**

from -10°C to +140°C.

**Maximum ambient temperature** +40°C.

**Maximum working pressure**

16 bar - 1600 kPa (for DN 200 max. 10 bar).

**Flanging**

PN 16 DIN 2533 - PN 10 DIN 2532 for DN 200

**Installation** normally horizontal.

**Special versions on request** pumps for liquids other than water.

Other voltages and/or frequencies.

IE3 ≥ 0,75 kW

ACCESSORIES  
PAG. 207

MODEL		POWER (kW)		CAST IRON IMPELLER	VOLTAGE 50 Hz	In A	FLANGE DIMENSIONS (mm)		BRONZE IMPELLER	STANDARD COUPLING	SPACER COUPLING
		4 POLES	2 POLES	CODE			DNA	DNM	CODE		
KDN 32-125.1	4 poles	0,37	-	1D1K11113	3 x 230 - 400 V ~	1,7/0,975	50	32	1D1K21113	81	86
		0,55	-	1D1K11123	3 x 230 - 400 V ~	2,6/1,5	50	32	1D1K21123	83	88
	2 poles	-	0,75	1D1K1113U	3 x 230 - 400 V ~	2,9/1,7	50	32	1D1K2113U	79	84
		-	1,1	1D1K1114U	3 x 230 - 400 V ~	4,2/2,4	50	32	1D1K2114U	79	84
		-	1,5	1D1K1115U	3 x 230 - 400 V ~	5,2/3	50	32	1D1K2115U	87	92
		-	2,2	1D1K1116U	3 x 230 - 400 V ~	8/4,6	50	32	1D1K2116U	92	97
		-	3	1D1K1117V	3 x 400 V ~ (1)	5,6	50	32	1D1K2117V	91	96
-	4	1D1K1118V	3 x 400 V ~ (1)	7	50	32	1D1K2118V	84	89		
KDN 32-125	4 poles	0,37	-	1D1111113	3 x 230 - 400 V ~	1,7/0,975	50	32	1D1121113	81	86
		0,55	-	1D1111123	3 x 230 - 400 V ~	2,6/1,5	50	32	1D1121123	83	88
		0,75	-	1D111113W	3 x 230 - 400 V ~	3,1/1,8	50	32	1D112113W	78	83
	2 poles	-	1,1	1D111114U	3 x 230 - 400 V ~	4,2/2,4	50	32	1D112114U	78	83
		-	1,5	1D111115U	3 x 230 - 400 V ~	5,2/3	50	32	1D112115U	80	85
		-	2,2	1D111116U	3 x 230 - 400 V ~	8/4,6	50	32	1D112116U	85	90
		-	3	1D111117V	3 x 400 V ~ (1)	5,6	50	32	1D112117V	85	90
		-	4	1D111118V	3 x 400 V ~ (1)	7	50	32	1D112118V	99	104

(1) Star starting is possible





MODEL	POWER (kW)		CAST IRON IMPELLER			FLANGE DIMENSIONS (mm)		BRONZE IMPELLER	STANDARD COUPLING	SPACER COUPLING	
	4 POLES	2 POLES	CODE	VOLTAGE 50 Hz	In A	DNA	DNM	CODE	WEIGHT Kg	WEIGHT Kg	
KDN 32-160.1	4 poles	0,37	-	1D1L1113	3 x 230 - 400 V ~	1,7/0,975	50	32	1D1L2113	83	88
		0,55	-	1D1L1123	3 x 230 - 400 V ~	2,6/1,5	50	32	1D1L2123	86	91
		0,75	-	1D1L113W	3 x 230 - 400 V ~	3,1/1,8	50	32	1D1L213W	80	85
	2 poles	-	1.1	1D1L114U	3 x 230 - 400 V ~	4,2/2,4	50	32	1D1L214U	81	86
		-	1.5	1D1L115U	3 x 230 - 400 V ~	5,2/3	50	32	1D1L215U	88	93
		-	2.2	1D1L116U	3 x 230 - 400 V ~	8/4,6	50	32	1D1L216U	94	99
		-	3	1D1L117V	3 x 400 V ~(-)	5,6	50	32	1D1L217V	91	96
		-	4	1D1L118V	3 x 400 V ~(-)	7	50	32	1D1L218V	86	91
		-	5.5	1D1L119V	3 x 400 V ~(-)	10	50	32	1D1L219V	117	122
		-	-	1D1L119V	3 x 400 V ~(-)	10	50	32	1D1L219V	117	122
KDN 32-160	4 poles	0,37	-	1D121113	3 x 230 - 400 V ~	1,7/0,975	50	32	1D122113	83	88
		0,55	-	1D121123	3 x 230 - 400 V ~	2,6/1,5	50	32	1D122123	85	90
		0,75	-	1D12113W	3 x 230 - 400 V ~	3,1/1,8	50	32	1D12213W	80	85
		1,1	-	1D12114W	3 x 230 - 400 V ~	4,3/2,5	50	32	1D12214W	78	83
	2 poles	-	2.2	1D12116U	3 x 230 - 400 V ~	8/4,6	50	32	1D12216U	84	92
		-	3	1D12117V	3 x 400 V ~(-)	5,6	50	32	1D12217V	91	96
		-	4	1D12118V	3 x 400 V ~(-)	7	50	32	1D12218V	86	91
		-	5.5	1D12119V	3 x 400 V ~(-)	10	50	32	1D12219V	117	122
		-	7.5	1D1211AV	3 x 400 V ~(-)	13,1	50	32	1D1221AV	925	118
		-	-	1D1211AV	3 x 400 V ~(-)	13,1	50	32	1D1221AV	925	118
KDN 32-200.1	4 poles	0,37	-	1D1M1113	3 x 230 - 400 V ~	1,7/0,975	50	32	1D1M2113	87	92
		0,55	-	1D1M1123	3 x 230 - 400 V ~	2,6/1,5	50	32	1D1M2123	89	94
		0,75	-	1D1M113W	3 x 230 - 400 V ~	1,7/0,975	50	32	1D1M213W	95	100
		1,1	-	1D1M114W	3 x 230 - 400 V ~	2,6/1,5	50	32	1D1M214W	96	101
	2 poles	-	2.2	1D1M116U	3 x 230 - 400 V ~	8/4,6	50	32	1D1M216U	98	103
		-	3	1D1M117V	3 x 400 V ~(-)	5,6	50	32	1D1M217V	129	134
		-	4	1D1M118V	3 x 400 V ~(-)	7	50	32	1D1M218V	125	130
		-	5.5	1D1M119V	3 x 400 V ~(-)	10	50	32	1D1M219V	124	129
		-	7.5	1D1M11AV	3 x 400 V ~(-)	13,1	50	32	1D1M21AV	925	145
		-	-	1D1M11AV	3 x 400 V ~(-)	13,1	50	32	1D1M21AV	925	145
KDN 32-200	4 poles	0,37	-	1D131113	3 x 230 - 400 V ~	1,7/0,975	50	32	1D132113	87	92
		0,55	-	1D131123	3 x 230 - 400 V ~	2,6/1,5	50	32	1D132123	89	94
		0,75	-	1D13113W	3 x 230 - 400 V ~	3,1/1,8	50	32	1D13213W	84	89
		1,1	-	1D13114W	3 x 230 - 400 V ~	4,3/2,5	50	32	1D13214W	91	96
		1,5	-	1D13115W	3 x 230 - 400 V ~	6,2/3,6	50	32	1D13215W	87	92
		2,2	-	1D13116W	3 x 230 - 400 V ~	10,2/5,9	50	32	1D13216W	92	97
	2 poles	-	3	1D13117V	3 x 400 V ~(-)	5,6	50	32	1D13217V	92	97
		-	4	1D13118V	3 x 400 V ~(-)	7	50	32	1D13218V	86	91
		-	5.5	1D13119V	3 x 400 V ~(-)	10	50	32	1D13219V	124	129
		-	7.5	1D1311AV	3 x 400 V ~(-)	13,1	50	32	1D1321AV	151	156
		-	11	1D1311BV	3 x 400 V ~(-)	19,7	50	32	1D1321BV	214	219
		-	15	1D1311CV	3 x 400 V ~(-)	26,7	50	32	1D1321CV	221	226
		-	-	1D1311CV	3 x 400 V ~(-)	26,7	50	32	1D1321CV	221	226
KDN 40-125	4 poles	0,37	-	1D211113	3 x 230 - 400 V ~	1,7/0,975	65	40	1D212113	81	86
		0,55	-	1D211123	3 x 230 - 400 V ~	2,6/1,5	65	40	1D212123	83	88
		0,75	-	1D21113W	3 x 230 - 400 V ~	3,1/1,8	65	40	1D21213W	78	83
		1,1	-	1D21114W	3 x 230 - 400 V ~	4,3/2,5	65	40	1D21214W	76	71
	2 poles	-	1.5	1D21115U	3 x 230 - 400 V ~	5,2/3	65	40	1D21215U	80	85
		-	2.2	1D21116U	3 x 230 - 400 V ~	8/4,6	65	40	1D21216U	83	88
		-	3	1D21117V	3 x 400 V ~(-)	5,6	65	40	1D21217V	80	85
		-	4	1D21118V	3 x 400 V ~(-)	7	65	40	1D21218V	84	89
		-	5.5	1D21119V	3 x 400 V ~(-)	10	65	40	1D21219V	115	120
		-	7.5	1D2111AV	3 x 400 V ~(-)	13,1	65	40	1D2121AV	925	116
KDN 40-160	4 poles	0,37	-	1D221113	3 x 230 - 400 V ~	1,7/0,975	65	40	1D222113	85	90
		0,55	-	1D221123	3 x 230 - 400 V ~	2,6/1,5	65	40	1D222123	89	94
		0,75	-	1D22113W	3 x 230 - 400 V ~	3,1/1,8	65	40	1D22213W	83	88
		1,1	-	1D22114W	3 x 230 - 400 V ~	4,3/2,5	65	40	1D22214W	81	86
		1,5	-	1D22115W	3 x 230 - 400 V ~	6,2/3,6	65	40	1D22215W	87	92
	2 poles	-	3	1D22117V	3 x 400 V ~(-)	5,6	65	40	1D22217V	91	96
		-	4	1D22118V	3 x 400 V ~(-)	7	65	40	1D22218V	86	91
		-	5.5	1D22119V	3 x 400 V ~(-)	10	65	40	1D22219V	141	146
		-	7.5	1D2211AV	3 x 400 V ~(-)	13,1	65	40	1D2221AV	139	144
		-	11	1D2211BV	3 x 400 V ~(-)	19,7	65	40	1D2221BV	150	155
		-	15	1D2211CV	3 x 400 V ~(-)	26,7	65	40	1D2221CV	146	151
		-	-	1D2211CV	3 x 400 V ~(-)	26,7	65	40	1D2221CV	146	151
		-	-	1D2211CV	3 x 400 V ~(-)	26,7	65	40	1D2221CV	146	151

(1) Star starting is possible



MODEL	POWER (kW)		CAST IRON IMPELLER		VOLTAGE 50 Hz	In A	FLANGE DIMENSIONS (mm)		BRONZE IMPELLER		STANDARD COUPLING	SPACER COUPLING
	4 POLES	2 POLES	CODE	CODE			DNA	DNM	CODE	WEIGHT Kg	WEIGHT Kg	
KDN 40-200	4 poles	0.55	–	1D2311123	3 x 230 - 400 V ~	2,6/1,5	65	40	1D2321123	98	103	
		0.75	–	1D231113W	3 x 230 - 400 V ~	3,1/1,8	65	40	1D232113W	92	97	
		1.1	–	1D231114W	3 x 230 - 400 V ~	4,3/2,5	65	40	1D232114W	91	96	
		1.5	–	1D231115W	3 x 230 - 400 V ~	6,2/3,6	65	40	1D232115W	91	96	
		2.2	–	1D231116W	3 x 230 - 400 V ~	10,2/5,9	65	40	1D232116W	101	106	
	2 poles	3	–	1D231117X	3 x 400 V ~(-)	6,8	65	40	1D232117X	104	109	
		–	4	1D231118V	3 x 400 V ~(-)	7	65	40	1D232118V	117	122	
		–	5.5	1D231119V	3 x 400 V ~(-)	10	65	40	1D232119V	127	132	
		–	7.5	1D23111AV	3 x 400 V ~(-)	13,1	65	40	1D23211AV	121	126	
		–	11	1D23111BV	3 x 400 V ~(-)	19,7	65	40	1D23211BV	198	203	
KDN 40-250	4 poles	1.5	–	1D241115W	3 x 230 - 400 V ~	6,2/3,6	65	40	1D242115W	111	116	
		2.2	–	1D241116W	3 x 230 - 400 V ~	10,2/5,9	65	40	1D242116W	119	124	
		3	–	1D241117X	3 x 400 V ~(-)	6,8	65	40	1D242117X	135	140	
		4	–	1D241118X	3 x 400 V ~(-)	8,2	65	40	1D242118X	179	184	
	2 poles	–	11	1D24111BV	3 x 400 V ~(-)	19,7	65	40	1D24211BV	213	218	
		–	15	1D24111CV	3 x 400 V ~(-)	26,7	65	40	1D24211CV	251	256	
		–	18.5	1D24111DV	3 x 400 V ~(-)	33	65	40	1D24211DV	266	271	
		–	22	1D24111EV	3 x 400 V ~(-)	38,1	65	40	1D24211EV	278	283	
		–	30	1D24111FV	3 x 400 V ~(-)	52,1	65	40	1D24211FV	332	337	
		KDN 50-125	4 poles	0.37	–	1D3111113	3 x 230 - 400 V ~	1,7/0,975	65	50	1D3121113	87
0.55	–			1D3111123	3 x 230 - 400 V ~	2,6/1,5	65	50	1D3121123	90	95	
0.75	–			1D311113W	3 x 230 - 400 V ~	3,1/1,8	65	50	1D312113W	85	90	
1.1	–			1D311114W	3 x 230 - 400 V ~	4,3/2,5	65	50	1D312114W	83	88	
1.5	–			1D311115W	3 x 230 - 400 V ~	6,2/3,6	65	50	1D312115W	87	92	
2 poles	–		3	1D311117V	3 x 400 V ~(-)	5,6	65	50	1D312117V	94	99	
	–		4	1D311118V	3 x 400 V ~(-)	7	65	50	1D312118V	91	96	
	–		5.5	1D311119V	3 x 400 V ~(-)	10	65	50	1D312119V	143	148	
	–		7.5	1D31111AV	3 x 400 V ~(-)	13,1	65	50	1D31211AV	117	122	
	–		11	1D31111BV	3 x 400 V ~(-)	19,7	65	50	1D31211BV	120	125	
KDN 50-160	4 poles	0.55	–	1D3211123	3 x 230 - 400 V ~	2,6/1,5	65	50	1D3221123	97	102	
		0.75	–	1D321113W	3 x 230 - 400 V ~	3,1/1,8	65	50	1D322113W	92	97	
		1.1	–	1D321114W	3 x 230 - 400 V ~	4,3/2,5	65	50	1D322114W	90	95	
		1.5	–	1D321115W	3 x 230 - 400 V ~	6,2/3,6	65	50	1D322115W	89	94	
		2.2	–	1D321116W	3 x 230 - 400 V ~	10,2/5,9	65	50	1D322116W	97	102	
		3	–	1D321117X	3 x 400 V ~(-)	6,8	65	50	1D322117X	96	101	
	2 poles	–	4	1D321118V	3 x 400 V ~(-)	7	65	50	1D322118V	114	119	
		–	5.5	1D321119V	3 x 400 V ~(-)	10	65	50	1D322119V	124	129	
		–	7.5	1D32111AV	3 x 400 V ~(-)	13,1	65	50	1D32211AV	151	156	
		–	11	1D32111BV	3 x 400 V ~(-)	19,7	65	50	1D32211BV	165	170	
KDN 50-200	4 poles	–	15	1D32111CV	3 x 400 V ~(-)	26,7	65	50	1D32211CV	173	178	
		–	18.5	1D32111DV	3 x 400 V ~(-)	33	65	50	1D32211DV	170	175	
		0.75	–	1D331113W	3 x 230 - 400 V ~	3,1/1,8	65	50	1D332113W	98	103	
		1.1	–	1D331114W	3 x 230 - 400 V ~	4,3/2,5	65	50	1D332114W	97	102	
		1.5	–	1D331115W	3 x 230 - 400 V ~	6,2/3,6	65	50	1D332115W	100	105	
		2.2	–	1D331116W	3 x 230 - 400 V ~	10,2/5,9	65	50	1D332116W	113	118	
	2 poles	3	–	1D331117X	3 x 400 V ~(-)	6,8	65	50	1D332117X	108	113	
		4	–	1D331118X	3 x 400 V ~(-)	8,2	65	50	1D332118X	101	106	
		–	7.5	1D33111AV	3 x 400 V ~(-)	13,1	65	50	1D33211AV	150	155	
		–	11	1D33111BV	3 x 400 V ~(-)	19,7	65	50	1D33211BV	163	168	
KDN 50-200	2 poles	–	15	1D33111CV	3 x 400 V ~(-)	26,7	65	50	1D33211CV	253	258	
		–	18.5	1D33111DV	3 x 400 V ~(-)	33	65	50	1D33211DV	251	256	
		–	22	1D33111EV	3 x 400 V ~(-)	38,1	65	50	1D33211EV	248	253	
		–	30	1D33111FV	3 x 400 V ~(-)	52,1	65	50	1D33211FV	302	307	

(1) Star starting is possible



MODEL		POWER (kW)		CAST IRON IMPELLER	VOLTAGE 50 Hz	In A	FLANGE DIMENSIONS (mm)		BRONZE IMPELLER	STANDARD COUPLING	SPACER COUPLING
		4 POLES	2 POLES	CODE			CODE	WEIGHT Kg	WEIGHT Kg		
										DNA	DNM
KDN 50-250	4 poles	2.2	-	1D341116W	3 x 230 - 400 V ~	10,2/5,9	65	50	1D342116W	125	130
		3	-	1D341117X	3 x 400 V ~ (1)	6,8	65	50	1D342117X	124	129
		4	-	1D341118X	3 x 400 V ~ (1)	8,2	65	50	1D342118X	144	149
		5,5	-	1D341119X	3 x 400 V ~ (1)	10,6	65	50	1D342119X	165	170
	2 poles	-	15	1D34111CV	3 x 400 V ~ (1)	26,7	65	50	1D34211CV	233	238
		-	18,5	1D34111DV	3 x 400 V ~ (1)	33	65	50	1D34211DV	257	262
		-	22	1D34111EV	3 x 400 V ~ (1)	38,1	65	50	1D34211EV	277	282
		-	30	1D34111FV	3 x 400 V ~ (1)	52,1	65	50	1D34211FV	419	424
		-	37	1D34111GV	3 x 400 V ~ (1)	62,6	65	50	1D34211GV	358	363
		-	45	1D34111HV	3 x 400 V ~ (1)	78,4	65	50	1D34211HV	413	418
KDN 65-125	4 poles	0.37	-	1D4111113	3 x 230 - 400 V ~	1,7/0,975	80	65	1D4121113	94	99
		0.55	-	1D4111123	3 x 230 - 400 V ~	2,6/1,5	80	65	1D4121123	97	102
		0.75	-	1D411113W	3 x 230 - 400 V ~	3,1/1,8	80	65	1D412113W	92	97
		1.1	-	1D411114W	3 x 230 - 400 V ~	4,3/2,5	80	65	1D412114W	90	95
		1.5	-	1D411115W	3 x 230 - 400 V ~	6,2/3,6	80	65	1D412115W	89	94
		2.2	-	1D411116W	3 x 230 - 400 V ~	10,2/5,9	80	65	1D412116W	97	102
	2 poles	-	4	1D411118V	3 x 400 V ~ (1)	7	80	65	1D412118V	114	119
		-	5.5	1D411119V	3 x 400 V ~ (1)	10	80	65	1D412119V	124	129
		-	7.5	1D41111AV	3 x 400 V ~ (1)	13,1	80	65	1D41211AV	120	125
		-	11	1D41111BV	3 x 400 V ~ (1)	19,7	80	65	1D41211BV	152	157
-	15	1D41111CV	3 x 400 V ~ (1)	26,7	80	65	1D41211CV	153	158		
KDN 65-160	4 poles	0.75	-	1D421113W	3 x 230 - 400 V ~	3,1/1,8	80	65	1D422113W	95	100
		1.1	-	1D421114W	3 x 230 - 400 V ~	4,3/2,5	80	65	1D422114W	93	98
		1.5	-	1D421115W	3 x 230 - 400 V ~	6,2/3,6	80	65	1D422115W	100	105
		2.2	-	1D421116W	3 x 230 - 400 V ~	10,2/5,9	80	65	1D422116W	104	109
		3	-	1D421117X	3 x 400 V ~ (1)	6,8	80	65	1D422117X	134	139
		-	5.5	1D421119V	3 x 400 V ~ (1)	10	80	65	1D422119V	130	135
	2 poles	-	7.5	1D42111AV	3 x 400 V ~ (1)	13,1	80	65	1D42211AV	147	152
		-	11	1D42111BV	3 x 400 V ~ (1)	19,7	80	65	1D42211BV	160	165
		-	15	1D42111CV	3 x 400 V ~ (1)	26,7	80	65	1D42211CV	193	198
		-	18.5	1D42111DV	3 x 400 V ~ (1)	33	80	65	1D42211DV	188	193
-	22	1D42111EV	3 x 400 V ~ (1)	38,1	80	65	1D42211EV	178	183		
KDN 65-200	4 poles	1.1	-	1D431114W	3 x 230 - 400 V ~	4,3/2,5	80	65	1D432114W	131	136
		1.5	-	1D431115W	3 x 230 - 400 V ~	6,2/3,6	80	65	1D432115W	129	134
		2.2	-	1D431116W	3 x 230 - 400 V ~	10,2/5,9	80	65	1D432116W	137	142
		3	-	1D431117X	3 x 400 V ~ (1)	6,8	80	65	1D432117X	136	141
		4	-	1D431118X	3 x 400 V ~ (1)	8,2	80	65	1D432118X	129	134
		5,5	-	1D431119X	3 x 400 V ~ (1)	10,6	80	65	1D432119X	192	197
	2 poles	-	11	1D43111BV	3 x 400 V ~ (1)	19,7	80	65	1D43211BV	244	249
		-	15	1D43111CV	3 x 400 V ~ (1)	26,7	80	65	1D43211CV	252	257
		-	18.5	1D43111DV	3 x 400 V ~ (1)	33	80	65	1D43211DV	257	262
		-	22	1D43111EV	3 x 400 V ~ (1)	38,1	80	65	1D43211EV	290	295
-	30	1D43111FV	3 x 400 V ~ (1)	52,1	80	65	1D43211FV	418	423		
-	37	1D43111GV	3 x 400 V ~ (1)	62,6	80	65	1D43211GV	431	436		
KDN 65-250	4 poles	3	-	1D441117X	3 x 400 V ~ (1)	6,8	80	65	1D442117X	164	172
		4	-	1D441118X	3 x 400 V ~ (1)	8,2	80	65	1D442118X	164	172
		5,5	-	1D441119X	3 x 400 V ~ (1)	10,6	80	65	1D442119X	193	201
		7.5	-	1D44111AX	3 x 400 V ~ (1)	15,3	80	65	1D44211AX	238	246
		11	-	1D44111BX	3 x 400 V ~ (1)	22,4	80	65	1D44211BX	277	285
	2 poles	-	22	1D44111EV	3 x 400 V ~ (1)	38,1	80	65	1D44211EV	277	285
		-	30	1D44111FV	3 x 400 V ~ (1)	52,1	80	65	1D44211FV	472	480
		-	37	1D44111GV	3 x 400 V ~ (1)	62,6	80	65	1D44211GV	502	510
		-	45	1D44111HV	3 x 400 V ~ (1)	78,4	80	65	1D44211HV	589	597
		-	55	1D44111KV	3 x 400 V ~ (1)	94,6	80	65	1D44211KV	717	725

(1) Star starting is possible



MODEL	POWER (kW)		CAST IRON IMPELLER		VOLTAGE 50 Hz	In A	FLANGE DIMENSIONS (mm)		BRONZE IMPELLER		STANDARD COUPLING	SPACER COUPLING
	4 POLES	2 POLES	CODE	CODE			DNA	DNM	CODE	WEIGHT Kg	WEIGHT Kg	
KDN 65-315	4 poles	5.5	-	1D451119X	3 x 400 V ~ (f)	10,6	80	65	1D452119X	251	259	
		7.5	-	1D45111AX	3 x 400 V ~ (f)	15,3	80	65	1D45211AX	273	281	
		11	-	1D45111BX	3 x 400 V ~ (f)	22,4	80	65	1D45211BX	271	279	
		15	-	1D45111CX	3 x 400 V ~ (f)	30,5	80	65	1D45211CX	272	280	
		18.5	-	1D45111DX	3 x 400 V ~ (f)	34,3	80	65	1D45211DX	291	299	
	2 poles	-	45	1D45111HV	3 x 400 V ~ (f)	78,4	80	65	1D45211HV	734	742	
		-	55	1D45111KV	3 x 400 V ~ (f)	94,6	80	65	1D45211KV	740	748	
		-	75	1D45111LV	3 x 400 V ~ (f)	127	80	65	1D45211LV	849	857	
		-	90	-	3 x 400 V ~ (f)	153	80	65	1D45211MV	651	659	
		-	110	-	3 x 400 V ~ (f)	185	80	65	1D45211NV	1219	1227	
KDN 80-160	4 poles	1.1	-	1D521114W	3 x 230 - 400 V ~	4,3/2,5	100	80	1D522114W	115	123	
		1.5	-	1D521115W	3 x 230 - 400 V ~	6,2/3,6	100	80	1D522115W	113	121	
		2.2	-	1D521116W	3 x 230 - 400 V ~	10,2/5,9	100	80	1D522116W	129	137	
		3	-	1D521117X	3 x 400 V ~ (f)	6,8	100	80	1D522117X	124	132	
		4	-	1D521118X	3 x 400 V ~ (f)	8,2	100	80	1D522118X	117	125	
		5,5	-	1D521119X	3 x 400 V ~ (f)	10,6	100	80	1D522119X	155	163	
	2 poles	-	7.5	1D52111AV	3 x 400 V ~ (f)	13,1	100	80	1D52211AV	163	171	
		-	11	1D52111BV	3 x 400 V ~ (f)	19,7	100	80	1D52211BV	275	283	
		-	15	1D52111CV	3 x 400 V ~ (f)	26,7	100	80	1D52211CV	271	279	
		-	18.5	1D52111DV	3 x 400 V ~ (f)	33	100	80	1D52211DV	266	274	
		-	22	1D52111EV	3 x 400 V ~ (f)	38,1	100	80	1D52211EV	211	219	
		-	30	1D52111FV	3 x 400 V ~ (f)	52,1	100	80	1D52211FV	316	324	
		-	37	1D52111GV	3 x 400 V ~ (f)	62,6	100	80	1D52211GV	408	416	
		-	45	1D52111HV	3 x 400 V ~ (f)	78,4	100	80	1D52211HV	587	595	
KDN 80-200	4 poles	1.5	-	1D531115W	3 x 230 - 400 V ~	6,2/3,6	100	80	1D532115W	147	155	
		2.2	-	1D531116W	3 x 230 - 400 V ~	10,2/5,9	100	80	1D532116W	156	164	
		3	-	1D531117X	3 x 400 V ~ (f)	6,8	100	80	1D532117X	154	162	
		4	-	1D531118X	3 x 400 V ~ (f)	8,2	100	80	1D532118X	167	175	
		5,5	-	1D531119X	3 x 400 V ~ (f)	10,6	100	80	1D532119X	180	188	
		7.5	-	1D53111AX	3 x 400 V ~ (f)	15,3	100	80	1D53211AX	169	177	
		11	-	1D53111BX	3 x 400 V ~ (f)	22,4	100	80	1D53211BX	171	179	
	2 poles	-	18.5	1D53111DV	3 x 400 V ~ (f)	33	100	80	1D53211DV	207	215	
		-	22	1D53111EV	3 x 400 V ~ (f)	38,1	100	80	1D53211EV	233	241	
		-	30	1D53111FV	3 x 400 V ~ (f)	52,1	100	80	1D53211FV	444	452	
		-	37	1D53111GV	3 x 400 V ~ (f)	62,6	100	80	1D53211GV	480	488	
		-	45	1D53111HV	3 x 400 V ~ (f)	78,4	100	80	1D53211HV	587	595	
		-	55	1D53111KV	3 x 400 V ~ (f)	94,6	100	80	1D53211KV	539	547	
		-	75	1D53111LV	3 x 400 V ~ (f)	127	100	80	1D53211LV	609	617	
KDN 80-250	4 poles	4	-	1D541118X	3 x 400 V ~ (f)	8,2	100	80	1D542118X	198	206	
		5.5	-	1D541119X	3 x 400 V ~ (f)	10,6	100	80	1D542119X	211	219	
		7.5	-	1D54111AX	3 x 400 V ~ (f)	15,3	100	80	1D54211AX	200	208	
		11	-	1D54111BX	3 x 400 V ~ (f)	22,4	100	80	1D54211BX	232	240	
		15	-	1D54111CX	3 x 400 V ~ (f)	30,5	100	80	1D54211CX	252	260	
	2 poles	-	37	1D54111GV	3 x 400 V ~ (f)	62,6	100	80	1D54211GV	496	504	
		-	45	1D54111HV	3 x 400 V ~ (f)	78,4	100	80	1D54211HV	584	592	
		-	55	1D54111KV	3 x 400 V ~ (f)	94,6	100	80	1D54211KV	695	703	
		-	75	1D54111LV	3 x 400 V ~ (f)	127	100	80	1D54211LV	641	649	
		-	90	1D54111MV	3 x 400 V ~ (f)	153	100	80	1D54211MV	891	899	
KDN 80-315	4 poles	7.5	-	1D55111AX	3 x 400 V ~ (f)	15,3	100	80	1D55211AX	371	379	
		11	-	1D55111BX	3 x 400 V ~ (f)	22,4	100	80	1D55211BX	364	372	
		15	-	1D55111CX	3 x 400 V ~ (f)	30,5	100	80	1D55211CX	365	373	
		18.5	-	1D55111DX	3 x 400 V ~ (f)	34,3	100	80	1D55211DX	378	386	
		22	-	1D55111EX	3 x 400 V ~ (f)	40,2	100	80	1D55211EX	318	326	
		30	-	1D55111FX	3 x 400 V ~ (f)	53,7	100	80	1D55211FX	384	392	
	2 poles	-	55	1D55111KV	3 x 400 V ~ (f)	94,6	100	80	1D55211KV	720	728	
		-	75	-	3 x 400 V ~ (f)	127	100	80	1D55211LV	840	848	
		-	90	-	3 x 400 V ~ (f)	153	100	80	1D55211MV	663	671	
		-	110	-	3 x 400 V ~ (f)	185	100	80	1D55211NV	1231	1239	

(1) Star starting is possible



MODEL	POWER (kW)		CAST IRON IMPELLER	VOLTAGE 50 Hz	In A	FLANGE DIMENSIONS (mm)		BRONZE IMPELLER	STANDARD COUPLING	SPACER COUPLING	
	4 POLES	2 POLES	CODE			DNA	DNM	CODE	WEIGHT Kg	WEIGHT Kg	
KDN 100-200	4 poles	3	-	1D631117X	3 x 400 V ~ (1)	6,8	125	100	1D632117X	167	175
		4	-	1D631118X	3 x 400 V ~ (1)	8,2	125	100	1D632118X	167	175
		5,5	-	1D631119X	3 x 400 V ~ (1)	10,6	125	100	1D632119X	206	214
		7,5	-	1D63111AX	3 x 400 V ~ (1)	15,3	125	100	1D63211AX	190	198
		11	-	1D63111BX	3 x 400 V ~ (1)	22,4	125	100	1D63211BX	281	289
		15	-	1D63111CX	3 x 400 V ~ (1)	30,5	125	100	1D63211CX	355	363
	2 poles	-	30	1D63111FV	3 x 400 V ~ (1)	52,1	125	100	1D63211FV	466	474
		-	37	1D63111GV	3 x 400 V ~ (1)	62,6	125	100	1D63211GV	427	435
		-	45	1D63111HV	3 x 400 V ~ (1)	78,4	125	100	1D63211HV	588	596
		-	55	1D63111KV	3 x 400 V ~ (1)	94,6	125	100	1D63211KV	668	676
		-	75	1D63111LV	3 x 400 V ~ (1)	127	125	100	1D63211LV	621	629
-	90	1D63111MV	3 x 400 V ~ (1)	153	125	100	1D63211MV	603	611		
KDN 100-250	4 poles	5,5	-	1D641119X	3 x 400 V ~ (1)	10,6	125	100	1D642119X	233	241
		7,5	-	1D64111AX	3 x 400 V ~ (1)	15,3	125	100	1D64211AX	231	239
		11	-	1D64111BX	3 x 400 V ~ (1)	22,4	125	100	1D64211BX	266	274
		15	-	1D64111CX	3 x 400 V ~ (1)	30,5	125	100	1D64211CX	275	283
		18,5	-	1D64111DX	3 x 400 V ~ (1)	34,3	125	100	1D64211DX	547	555
	2 poles	-	45	1D64111HV	3 x 400 V ~ (1)	78,4	125	100	1D64211HV	735	743
		-	55	1D64111KV	3 x 400 V ~ (1)	94,6	125	100	1D64211KV	741	749
		-	75	1D64111LV	3 x 400 V ~ (1)	127	125	100	1D64211LV	850	858
		-	90	1D64111MV	3 x 400 V ~ (1)	153	125	100	1D64211MV	652	660
		-	110	1D64111NV	3 x 400 V ~ (1)	185	125	100	1D64211NV	1220	1228
KDN 100-315	4 poles	11	-	1D65111BX	3 x 400 V ~ (1)	22,4	125	100	1D65211BX	287	295
		15	-	1D65111CX	3 x 400 V ~ (1)	30,5	125	100	1D65211CX	275	283
		18,5	-	1D65111DX	3 x 400 V ~ (1)	34,3	125	100	1D65211DX	315	323
		22	-	1D65111EX	3 x 400 V ~ (1)	40,2	125	100	1D65211EX	342	350
		30	-	1D65111FX	3 x 400 V ~ (1)	53,7	125	100	1D65211FX	458	466
		37	-	1D65111GX	3 x 400 V ~ (1)	66,1	125	100	1D65211GX	524	532
KDN 125-250	4 poles	7,5	-	1D74111AX	3 x 400 V ~ (1)	15,3	150	125	1D74211AX	291	299
		11	-	1D74111BX	3 x 400 V ~ (1)	22,4	150	125	1D74211BX	302	310
		15	-	1D74111CX	3 x 400 V ~ (1)	30,5	150	125	1D74211CX	391	399
		18,5	-	1D74111DX	3 x 400 V ~ (1)	34,3	150	125	1D74211DX	391	399
		22	-	1D74111EX	3 x 400 V ~ (1)	40,2	150	125	1D74211EX	433	441
		30	-	1D74111FX	3 x 400 V ~ (1)	53,7	150	125	1D74211FX	511	519
KDN 150-200	4 poles	5,5	-	1D831119X	3 x 400 V ~ (1)	10,6	200	150	1D832119X	446	454
		7,5	-	1D83111AX	3 x 400 V ~ (1)	15,3	200	150	1D83211AX	451	459
		11	-	1D83111BX	3 x 400 V ~ (1)	22,4	200	150	1D83211BX	455	463
		15	-	1D83111CX	3 x 400 V ~ (1)	30,5	200	150	1D83211CX	476	484
		18,5	-	1D83111DX	3 x 400 V ~ (1)	34,3	200	150	1D83211DX	504	512

(1) Star starting is possible



### TECHNICAL DATA - HYDRAULIC PART

MODEL	CODE	DNA	DNM	Weight Kg
KDN 32-125.1	1D1K11000	50	32	37
KDN 32-125	1D1111000	50	32	36
KDN 32-160.1	1D1L11000	50	32	38
KDN 32-160	1D1211000	50	32	38
KDN 32-200.1	1D1M11000	50	32	46
KDN 32-200	1D1311000	50	32	46
KDN 40-125	1D2111000	65	40	39
KDN 40-160	1D2211000	65	40	41
KDN 40-200	1D2311000	65	40	49
KDN 40-250	1D2411000	65	40	57
KDN 50-125	1D3111000	65	50	42
KDN 50-160	1D3211000	65	50	44
KDN 50-200	1D3311000	65	50	51
KDN 50-250	1D3411000	65	50	59
KDN 65-125	1D4111000	80	65	46
KDN 65-160	1D4211000	80	65	47
KDN 65-200	1D4311000	80	65	66
KDN 65-250	1D4411000	80	65	93
KDN 65-315	1D4511000	80	65	112
KDN 80-160	1D5211000	100	80	55
KDN 80-200	1D5311000	100	80	84
KDN 80-250	1D5411000	100	80	104
KDN 80-315	1D5511000	100	80	122
KDN 100-200	1D6311000	125	100	96
KDN 100-250	1D6411000	125	100	111
KDN 100-315	1D6511000	125	100	126
KDN 125-250	1D7411000	150	125	135
KDN 150-200	1D8311000	200	150	178

### CAST IRON IMPELLER



MODEL	CODE	DNA	DNM	Weight Kg.
KDN 32-125.1	1D1K21000	50	32	37
KDN 32-125	1D1121000	50	32	37
KDN 32-160.1	1D1L21000	50	32	38
KDN 32-160	1D1221000	50	32	38
KDN 32-200.1	1D1M21000	50	32	38
KDN 32-200	1D1321000	50	32	48
KDN 40-125	1D2121000	65	40	40
KDN 40-160	1D2221000	65	40	41
KDN 40-200	1D2321000	65	40	52
KDN 40-250	1D2421000	65	40	58
KDN 50-125	1D3121000	65	50	42
KDN 50-160	1D3221000	65	50	44
KDN 50-200	1D3321000	65	50	52
KDN 50-250	1D3421000	65	50	60
KDN 65-125	1D4121000	80	65	47
KDN 65-160	1D4221000	80	65	49
KDN 65-200	1D4321000	80	65	58
KDN 65-250	1D4421000	80	65	99
KDN 65-315	1D4521000	80	65	114
KDN 80-160	1D5221000	100	80	57
KDN 80-200	1D5321000	100	80	82
KDN 80-250	1D5421000	100	80	107
KDN 80-315	1D5521000	100	80	124
KDN 100-200	1D6321000	125	100	98
KDN 100-250	1D6421000	125	100	115
KDN 100-315	1D6521000	125	100	133
KDN 125-250	1D7421000	150	125	133
KDN 150-200	1D8321000	200	150	178

### BRONZE IMPELLER



# KDN

STANDARDISED CENTRIFUGAL PUMPS



## SPECIAL VERSION

MODEL
KDN 32-125.1
KDN 32-125
KDN 32-160.1
KDN 32-160
KDN 32-200.1
KDN 32-200
KDN 40-125
KDN 40-160
KDN 40-200
KDN 40-250
KDN 50-125
KDN 50-160
KDN 50-200
KDN 50-250
KDN 65-125
KDN 65-160
KDN 65-200
KDN 65-250
KDN 65-315
KDN 80-160
KDN 80-200
KDN 80-250
KDN 80-315
KDN 100-200
KDN 100-250
KDN 100-315
KDN 125-250
KDN 150-200

### VERSIONS WITH SPECIAL MECHANICAL SEALS

(1) Ref. Technical catalogue  
Mechanical seal with rubber bellows:  
Silicon carbide / Silicon carbide / EPDM

(2) Ref. Technical catalogue  
Mechanical seal with rubber bellows:  
Silicon carbide / Silicon carbide / Viton

(3) Ref. Technical catalogue  
Mechanical seal with rubber bellows:  
Carbon / Silicon carbide / Viton

## SPECIAL VERSION

MODEL
KDN 32-125.1
KDN 32-125
KDN 32-160.1
KDN 32-160
KDN 32-200.1
KDN 32-200
KDN 40-125
KDN 40-160
KDN 40-200
KDN 40-250
KDN 50-125
KDN 50-160
KDN 50-200
KDN 50-250
KDN 65-125
KDN 65-160
KDN 65-200
KDN 65-250
KDN 65-315
KDN 80-160
KDN 80-200
KDN 80-250
KDN 80-315
KDN 100-200
KDN 100-250
KDN 100-315
KDN 125-250
KDN 150-200

### CATAPHORESIS COATING FOR COMPONENTS IN CONTACT WITH LIQUID FOR BRONZE IMPELLER VERSIONS

# KDN

STANDARDISED CENTRIFUGAL PUMPS



## SPECIAL VERSION

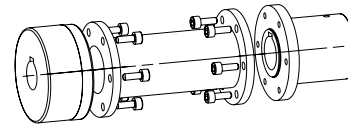
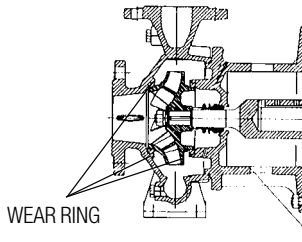

MODEL
KDN 32-125.1
KDN 32-125
KDN 32-160.1
KDN 32-160
KDN 32-200.1
KDN 32-200
KDN 40-125
KDN 40-160
KDN 40-200
KDN 40-250
KDN 50-125
KDN 50-160
KDN 50-200
KDN 50-250
KDN 65/125
KDN 65-160
KDN 65-200
KDN 65-250
KDN 65-315
KDN 80-160
KDN 80-200
KDN 80-250
KDN 80-315
KDN 100-200
KDN 100-250
KDN 100-315
KDN 125-250
KDN 150-200

### WITH WEAR RING

MODEL
KDN 32-125.1
KDN 32-125
KDN 32-160.1
KDN 32-160
KDN 32-200.1
KDN 32-200
KDN 40-125
KDN 40-160
KDN 40-200
KDN 40-250
KDN 50-125
KDN 50-160
KDN 50-200
KDN 50-250
KDN 65/125
KDN 65-160
KDN 65-200
KDN 65-250
KDN 65-315
KDN 80-160
KDN 80-200
KDN 80-250
KDN 80-315
KDN 100-200
KDN 100-250
KDN 100-315
KDN 125-250
KDN 150-200

### WITH SPACER COUPLING



# KDN OVERSIZE

## STANDARDISED CENTRIFUGAL PUMPS



Single-stage centrifugal pump body with axial suction port, radial discharge port and horizontal shaft components. The KDN pumps have dimensions and nominal performances according to EN 733 (10 bar) but are designed for 16 bar operation wherever the shaft seal type allows it. The suction and discharge flanges are according to EN 7005 PN 10 or 16. All pumps are dynamically balanced according to ISO 1940 class 6.3 and impellers are hydraulically balanced. Pump and motor are mounted on a common baseplate in accordance with EN 23 661 in all-welded steel. Oversizes have profile base frames. Due to the pump design the complete bearing assembly including impeller and shaft seal can be dismantled without removing the pump body from the pipe system (back-pull-out design). Asynchronous, closed and cooled with external ventilation, 2, 4 or 6 poles motors.

Electrical protection: in compliance with the EEC 89/336 ELECTROMAGNETIC COMPATIBILITY directive and subsequent amendments, EEC 73/23 LOW VOLTAGE directive and subsequent amendments and CEI 2-3 standards.

- Flow** Max. 2200 m<sup>3</sup>/h
- Head** Max. 158 m
- Liquid temperature** from -25°C to +140°C
- Operating pressure** Max. 16 bar
- Motor construction** B3
- Protection level** IP 55
- Insulation class** F
- Supply voltage** Three-phase 230-400V 50 Hz up to 2.2 kW included 400V 50 Hz over 2.2 kW
- Special versions on request** other voltages and/or frequencies
- IE3 motor efficiency class available on request. Please contact our sales network for more information.**

Complete electric pump or liquid end only is available

# KDN OVERSIZE - 2 POLES - STANDARDISED CENTRIFUGAL PUMPS ON SKID

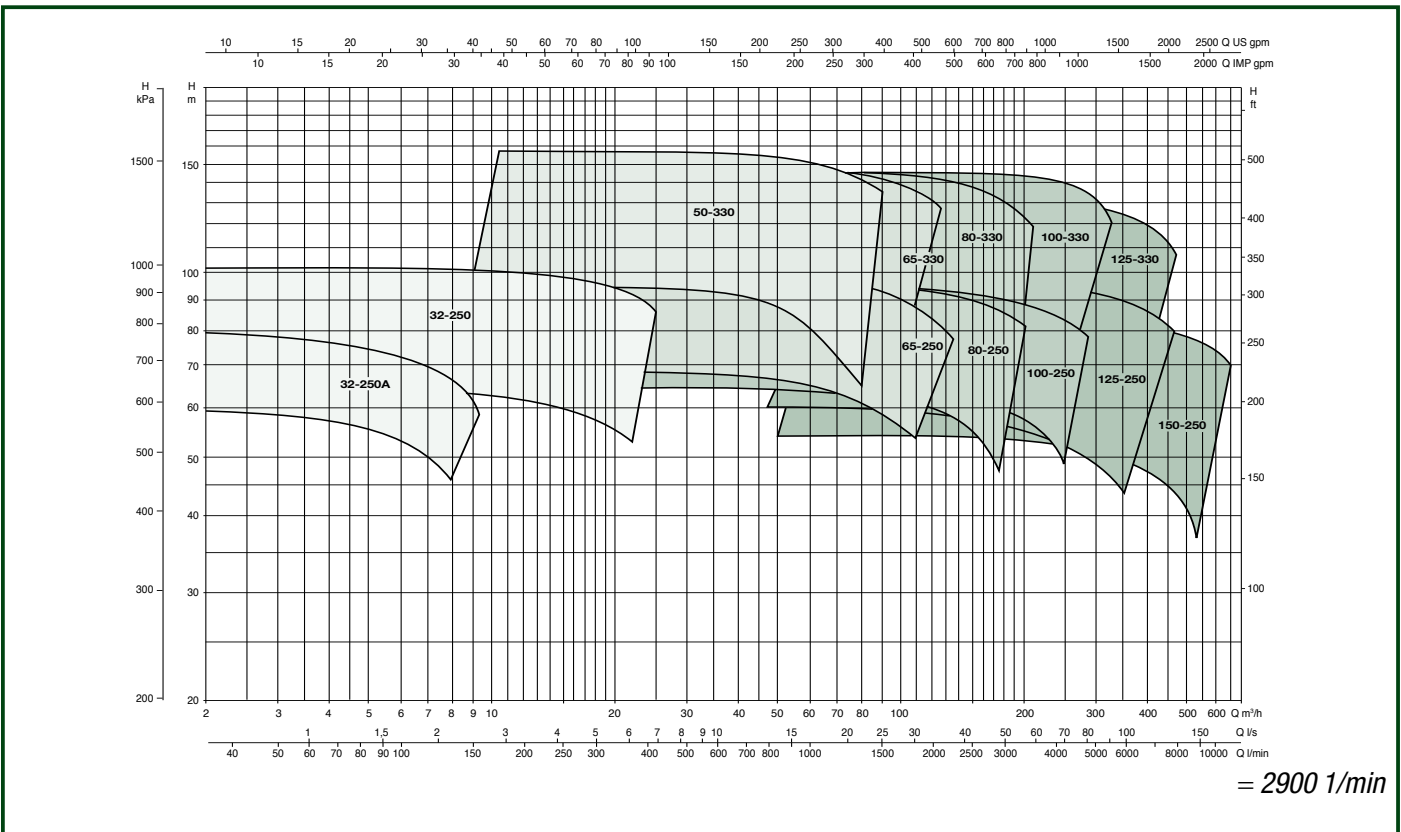

# KDN OVERSIZE

STANDARDISED CENTRIFUGAL PUMPS



## KDN OVERSIZE - 4 POLES - STANDARDISED CENTRIFUGAL PUMPS ON SKID

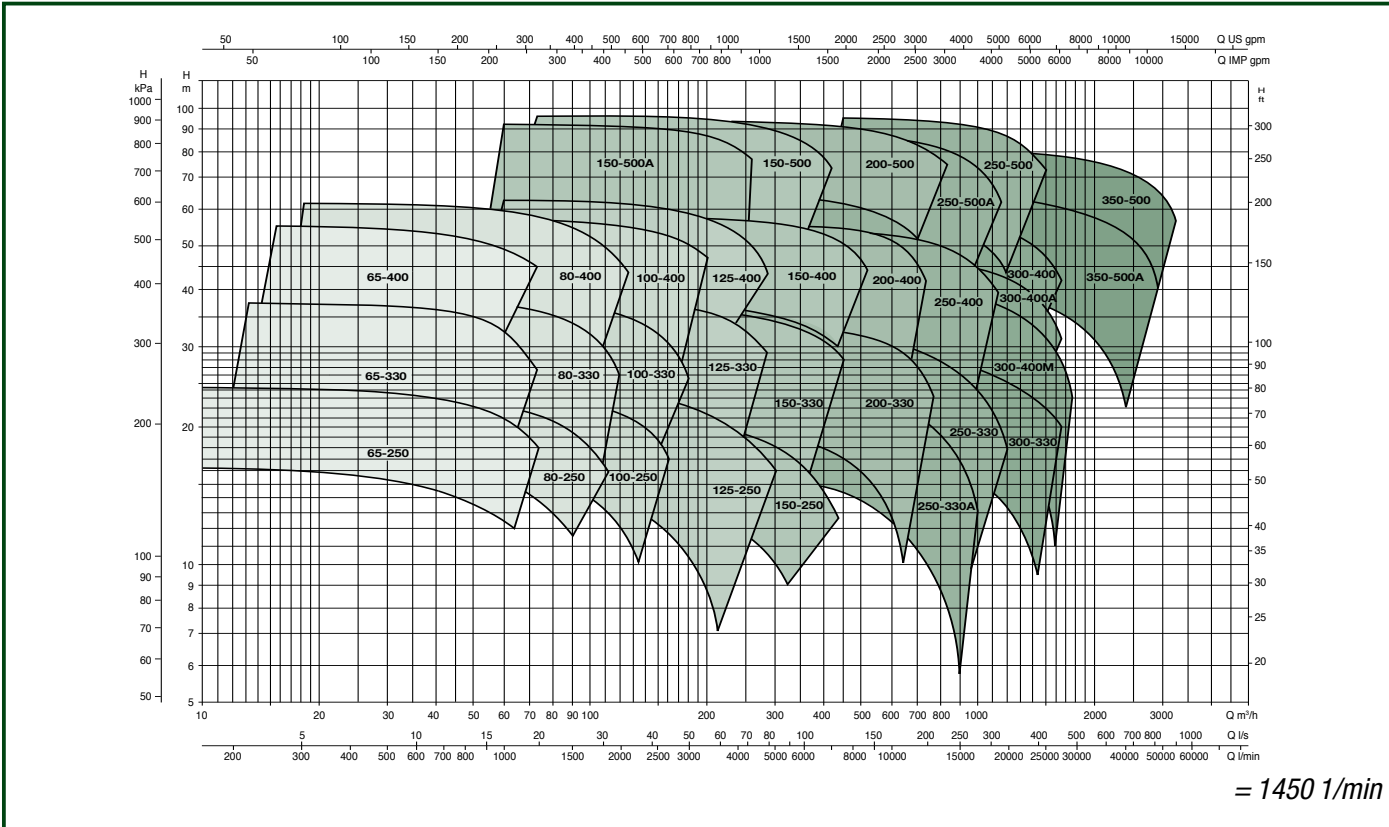

## KDN OVERSIZE - 6 POLES - STANDARDISED CENTRIFUGAL PUMPS ON SKID

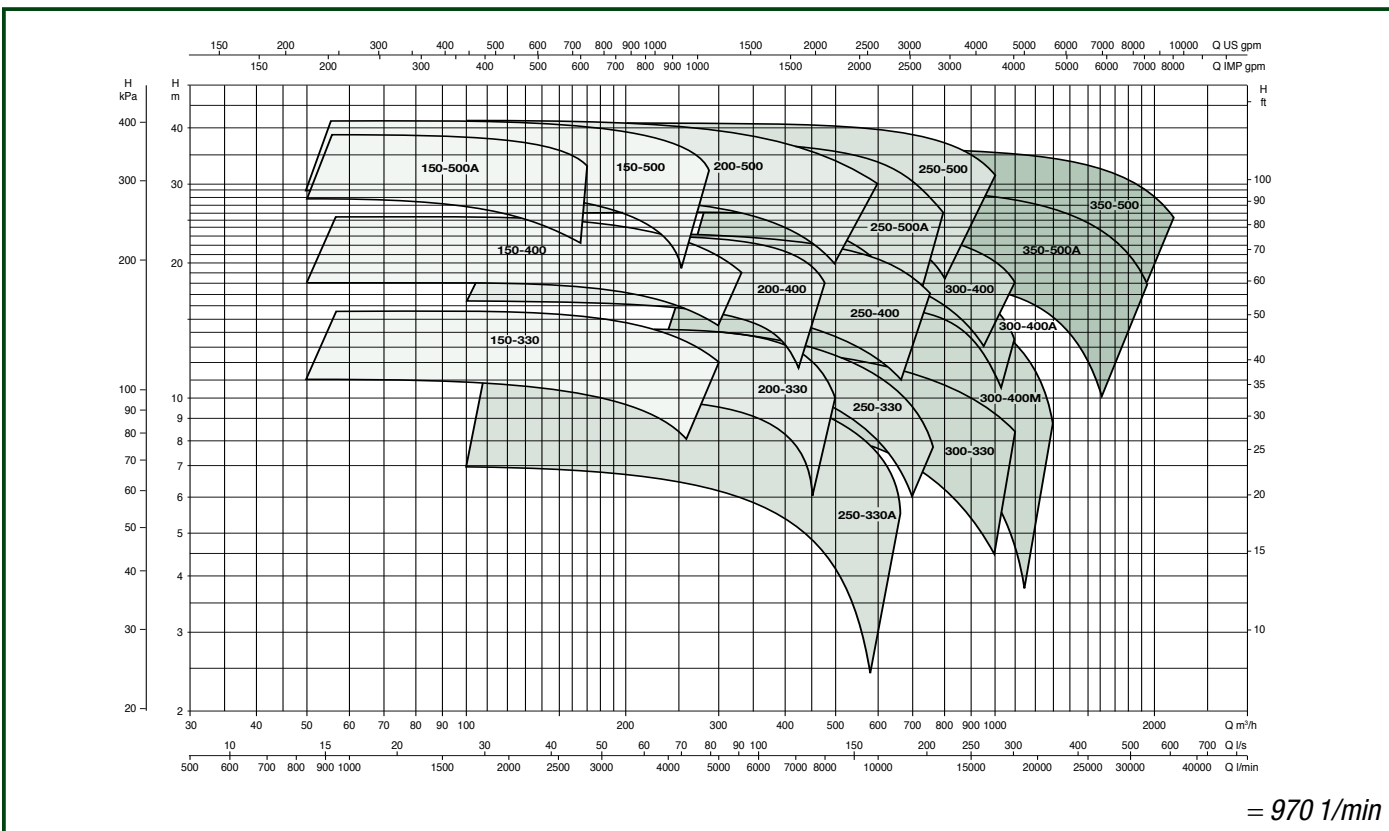

COMMAND AND CONTROL SYSTEMS

CIRCULATORS AND IN-LINE PUMPS

MULTISTAGE CENTRIFUGAL AND SELF-PRIMING PUMPS

SWIMMING POOL, POND AND SALT WATER PUMPS

CENTRIFUGAL PUMPS

SUBMERSIBLE PUMPS

SUBMERSIBLE PUMPS AND SUBMERSIBLE MOTORS

PRESSURE UNITS

# KVC / KVCX

MULTISTAGE CENTRIFUGAL PUMPS WITH VERTICAL AXIS



KVC



KVCX

Vertical multistage centrifugal pump suitable for use in small and medium water supply installations.

Suitable for pressurization units, surge tank supply, rain irrigation and crop-dusting systems, fire-fighting and washing systems, conveyance of condensate and cooling water.

Innovative and robust design.

Technopolymer discharge/suction bodies and in-line suction and discharge ports with threaded metal insert.

Impellers, diffuser bodies and diffusers in technopolymer, fully rust-proof. Stainless steel AISI 303 pump jacket, adjustment rings and seal disk.

Silicon carbide/Carbon graphite mechanical seal, fitted on the AISI 303 stainless-steel drive shaft extension.

Asynchronous, closed motor cooled by external ventilation. Rotor mounted on oversized greased sealed-for-life ball bearings to ensure silent running and long life.

Built-in thermal and current overload protection and a capacitor permanently on in the singlephase version.

Protection for the three-phase version is the responsibility of the user. Built in CEI 2-3/CEI 61/69 (EN 60335-2-41) standards.

**Level of protection** IP 55

**Insulation class** F

**Standard voltage**

Single-phase 220-240 V / 50 Hz

Three-phase 230-400 V / 50 Hz

**Operating range**

from 50 to 200 litre/min. with head up to 113 m.

**Pumped liquid** clean, free from solids or abrasive substances, not viscous, not aggressive, not crystallised and chemically neutral and close to the characteristics of water.

**Liquid temperature range**

from 0°C to +35°C for domestic use

(EN 60335-2-41 safety standards).

from 0°C to +40°C for other uses.

**Maximum ambient temperature** +40°C

**Maximum working pressure** 12 bar (1200 kPa).

**Installation** fixed, in vertical or horizontal position. Providing that the motor is positioned above the pump.

**Special versions on request**

Other voltages and/or frequencies.



**IE3 ≥ 0,75 kW**

**IE2 ≥ 0,75 kW EXTRA EU**

**ACCESSORIES  
PAG. 207**

## KVC

MODEL	CODE	ELECTRICAL DATA				HYDRAULIC DATA													DNA GAS	DNM GAS	H mm	WEIGHT Kg		
		VOLTAGE 50 Hz	P2 NOMINAL KW	HP	In A	MOTOR TYPE	Q=m <sup>3</sup> h	0	0,6	1,2	1,8	2,4	3	3,3	3,9	4,8	Q=l/min	0					10	20
KVC 15-30 M	60183593	1 x 220 - 240V ~	0,25	0,33	2,8	-		21,5	21,3	20,5	19,0	16,9	14,2	12,6	8,9		1" ¼	1" ¼	505	14,7				
KVC 15-30 T	60183594	3 x 230 / 400V ~	0,25	0,33	2,3-1,3	-		21,5	21,3	20,5	19,0	16,9	14,2	12,6	8,9		1" ¼	1" ¼	505	14,7				
KVC 25-30 M	60183412	1 x 220 - 240V ~	0,37	0,5	3,4	-		29,0	28,6	27,4	25,3	22,4	18,5	16,3	10,7		1" ¼	1" ¼	505	14,7				
KVC 25-30 T	60183416	3 x 230 / 400V ~	0,37	0,5	1,5-2,5	-		29,0	28,6	27,4	25,3	22,4	18,5	16,3	10,7		1" ¼	1" ¼	505	14,7				
KVC 35-30 M	60183595	1 x 220 - 240V ~	0,45	0,6	4,1	-		40,2	39,3	37,3	34,1	29,8	24,3	21,0	13,5		1" ¼	1" ¼	560	14,5				
KVC 35-30 T	60183596	3 x 230 / 400V ~	0,45	0,6	2,8-1,6	-		40,2	39,3	37,3	34,1	29,8	24,3	21,0	13,5		1" ¼	1" ¼	560	14,5				
KVC 45-30 M	60183413	1 x 220 - 240V ~	0,75	1	5,2	-		49,7	48,7	46,5	43,1	38,4	32,1	28,5	19,6		1" ¼	1" ¼	560	14,9				
KVC 45-30 T	60183417	3 x 230 / 400V ~	0,55	0,75	3-1,7	-		47,1	45,9	43,5	39,8	34,7	28,0	24,0	14,7		1" ¼	1" ¼	560	14,9				
KVC 50-30 M	60183597	1 x 220 - 240V ~	0,75	1,0	6	-		61,5	59,9	56,8	52,2	46,0	38,0	33,5	22,7		1" ¼	1" ¼	652	17,5				
KVC 50-30 T	60183599	3 x 230 / 400V ~	0,75	1,0	3,7-2,2	IE3		61,5	59,9	56,8	52,2	46,0	38,0	33,5	22,7		1" ¼	1" ¼	652	17,5				
KVC 60-30 M	60183414	1 x 220 - 240V ~	1	1,36	6,7	-		69,6	67,6	64,0	58,5	51,1	41,8	36,2	23,8		1" ¼	1" ¼	652	17,3				
KVC 60-30 T	60183600	3 x 230 / 400V ~	0,8	1,1	3,9-2,3	IE3		69,6	67,6	64,0	58,5	51,1	41,8	36,2	23,8		1" ¼	1" ¼	652	17,3				
KVC 65-30 M	60183415	1 x 220 - 240V ~	1	1,36	7,3	-		78,4	76,8	73,5	68,4	61,2	51,9	46,0	33,3		1" ¼	1" ¼	679	18,9				
KVC 65-30 T	60183601	3 x 230 / 400V ~	1	1,36	4,4-2,6	IE3		78,4	76,8	73,5	68,4	61,2	51,9	46,0	33,3		1" ¼	1" ¼	679	18,5				
KVC 20-50 M	102990360	1 x 220 - 240 V ~	0,37	0,5	2,5	-		27,4	26,9	26,0	24,9	23,1	21,1	19,8	16,9	11,4	1" ¼	1" ¼	450	13,5				
KVC 20-50 T	102990370	3 x 230 / 400 V ~	0,37	0,5	1,7-1,0	-		27,4	26,9	26,0	24,9	23,1	21,1	19,8	16,9	11,4	1" ¼	1" ¼	450	13,5				
KVC 30-50 M	102990100	1 x 220 - 240 V ~	0,55	0,75	4	-		41,1	40,3	39,0	37,3	34,7	31,6	29,7	25,3	17,1	1" ¼	1" ¼	478	13,7				
KVC 30-50 T	102990110	3 x 230 / 400 V ~	0,55	0,75	2,4-1,4	-		41,1	40,3	39,0	37,3	34,7	31,6	29,7	25,3	17,1	1" ¼	1" ¼	478	13,7				
KVC 40-50 M	102990120	1 x 220 - 240 V ~	0,8	1,1	5,6	-		54,9	53,7	52,0	49,7	46,3	42,1	39,6	33,7	22,9	1" ¼	1" ¼	505	15,8				
KVC 40-50 T	60179400	3 x 230 / 400 V ~	0,8	1,1	3,8-2,2	IE3		54,9	53,7	52,0	49,7	46,3	42,1	39,6	33,7	22,9	1" ¼	1" ¼	505	15,8				
KVC 55-50 M	102990140	1 x 220 - 240 V ~	1	1,36	6,4	-		68,6	67,1	65,0	62,1	57,9	52,7	49,5	42,1	28,6	1" ¼	1" ¼	533	17,0				
KVC 55-50 T	60179398	3 x 230 / 400 V ~	1	1,36	4,4-2,6	IE3		68,6	67,1	65,0	62,1	57,9	52,7	49,5	42,1	28,6	1" ¼	1" ¼	533	17,0				
KVC 65-50 M	102990160	1 x 220 - 240 V ~	1,1	1,5	7,4	-		82,3	80,6	78,0	74,6	69,4	63,2	59,4	50,6	34,3	1" ¼	1" ¼	600	20,2				
KVC 65-50 T	60179914	3 x 230 / 400 V ~	1,1	1,5	7-4	IE3		82,3	80,6	78,0	74,6	69,4	63,2	59,4	50,6	34,3	1" ¼	1" ¼	600	19,8				
KVC 75-50 M	102990180	1 x 220 - 240 V ~	1,5	2	9	-		96,0	94,0	91,0	87,0	81,0	73,8	69,3	59,0	40,0	1" ¼	1" ¼	627	21,2				
KVC 75-50 T	60179915	3 x 230 / 400 V ~	1,5	2	7,7-4,3	IE3		96,0	94,0	91,0	87,0	81,0	73,8	69,3	59,0	40,0	1" ¼	1" ¼	627	20,6				

# KVC / KVCX

MULTISTAGE CENTRIFUGAL PUMPS WITH VERTICAL AXIS



IE3 ≥ 0,75 kW

IE2 ≥ 0,75 kW

**EXTRA EU**

## KVC

MODEL	CODE	ELECTRICAL DATA				HYDRAULIC DATA																	DNA GAS	DNM GAS	H mm	Weight Kg	
		VOLTAGE 50 Hz	P2 NOMINAL		In A	MOTOR TYPE	Q=m³h	Q=l/min																			
			kW	HP				0	0,6	1,2	1,8	2,4	3	3,3	3,9	4,8	5,4	6	7,2	8,4	9	10,8					12
KVC 20-80 M	60183688	1 x 220 - 240V ~	0,55	0,75	4,2	-	25,0	24,8	24,4	23,8	23,1	22,3	21,5	20,5	19	17,3	16	11,9	7,4	4,8				G1"½	G1"¼	505	14,7
KVC 20-80 T	60183405	3 x 230 / 400V ~	0,55	0,75	2,8-1,6	-	25,0	24,8	24,4	23,8	23,1	22,3	21,5	20,5	19	17,3	16	11,9	7,4	4,8				G1"½	G1"¼	505	14,7
KVC 30-80 M	60183401	1 x 220 - 240V ~	1	1,36	6,5	-	36,9	36,9	36,6	36,1	35,3	34,3	33,6	32,2	29,5	27,8	25,5	20,3	14,2	10,7				G1"½	G1"¼	505	13,7
KVC 30-80 T	60183411	3 x 230 / 400V ~	1	1,36	3,9-2,3	IE3	36,9	36,9	36,6	36,1	35,3	34,3	33,6	32,2	29,5	27,8	25,5	20,3	14,2	10,7				G1"½	G1"¼	505	13,9
KVC 40-80 M	60183402	1 x 220 - 240V ~	1,1	1,5	7,4	-	50,1	49,7	49,0	48,0	46,7	45,1	44,2	42	38,5	35,7	32,5	25,5	17,1	12,5				G1"½	G1"¼	560	18
KVC 40-80 T	60183804	3 x 230 / 400V ~	1	1,5	4,6-2,7	IE3	50,1	49,7	49,0	48,0	46,7	45,1	44,2	42	38,5	35,7	32,5	25,5	17,1	12,5				G1"½	G1"¼	560	17,6
KVC 45-80 M	60183403	1 x 220 - 240V ~	1,6	2,2	9,7	-	64,6	64,5	63,9	63,0	61,7	60,0	59,0	56,7	52,5	49,3	45	37,1	26,8	21,1				G1"½	G1"¼	634	18
KVC 45-80 T	60183805	3 x 230 / 400V ~	1,6	2,2	6,2-3,6	IE3	64,6	64,5	63,9	63,0	61,7	60,0	59,0	56,7	52,5	49,3	45	37,1	26,8	21,1				G1"½	G1"¼	634	17,6
KVC 55-80 M	60183404	1 x 220 - 240V ~	1,85	2,5	11,2	-	76,1	75,8	75,1	73,9	72,2	70,0	68,5	66	60,5	56,7	52	41,8	29,5	22,7				G1"½	G1"¼	727	22
KVC 55-80 T	60183806	3 x 230 / 400V ~	1,85	2,5	7-4,1	IE3	76,1	75,8	75,1	73,9	72,2	70,0	68,5	66	60,5	56,7	52	41,8	29,5	22,7				G1"½	G1"¼	727	22,1
KVC 65-80 T	60183807	3 x 230 / 400V ~	2,2	3	8,3-4,8	IE3	88,6	88,0	86,9	85,5	83,5	81,2	80,0	76,5	71	67,0	62	51,1	37,9	30,5				G1"½	G1"¼	727	22,1
KVC 25-120 M	102990400	1 x 220 - 240 V ~	1	1,36	6,5	-	30,4	30,3	30,2	30,0	29,9	29,6	29,3	28,7	27,7	26,9	25,9	23,2	19,9	18,2	12,0	7,0		G1"½	G1"¼	450	17,0
KVC 25-120 T	60179878	3 x 230 / 400 V ~	1	1,36	5-2,9	IE3	30,4	30,3	30,2	30,0	29,9	29,6	29,3	28,7	27,7	26,9	25,9	23,2	19,9	18,2	12,0	7,0		G1"½	G1"¼	450	17,1
KVC 35-120 M	102990420	1 x 220 - 240 V ~	1,1	1,5	7,4	-	46,2	46,1	45,7	45,3	44,8	44,0	43,7	42,7	40,9	39,3	37,4	33,7	29,4	26,8	18,0	11,0		G1"½	G1"¼	480	20,1
KVC 35-120 T	60179872	3 x 230 / 400 V ~	1,1	1,5	6,4-3,7	IE3	46,2	46,1	45,7	45,3	44,8	44,0	43,7	42,7	40,9	39,3	37,4	33,7	29,4	26,8	18,0	11,0		G1"½	G1"¼	480	20,2
KVC 45-120 M	102990440	1 x 220 - 240 V ~	1,85	2,5	12	-	62,4	62,0	61,4	60,8	60,1	59,1	58,6	57,5	55,3	53,4	51,4	46,2	40,6	37,5	26,3	17,0		G1"½	G1"¼	507	20,2
KVC 45-120 T	60179863	3 x 230 / 400 V ~	1,85	2,5	7,6-4,4	IE3	62,4	62,0	61,4	60,8	60,1	59,1	58,6	57,5	55,3	53,4	51,4	46,2	40,6	37,5	26,3	17,0		G1"½	G1"¼	507	21,9
KVC 60-120 T	60179867	3 x 230 / 400 V ~	2,2	3	9-5,2	IE3	78,0	77,5	76,7	75,9	75,1	73,9	73,3	71,5	68,3	65,9	63,2	58,0	51,0	47	35,0	24,5		G1"½	G1"¼	610	21,6
KVC 70-120 T	60179876	3 x 230 / 400 V ~	3	4	10,9-6,3	IE3	95,0	94,3	93,4	92,5	91,4	89,8	88,9	86,8	83,2	80,5	77,9	71,7	63,9	59,2	44,0	31,0		G1"½	G1"¼	675	24,0
KVC 85-120 T	60179865	3 x 230 / 400 V ~	3	4	12,3-7,1	IE3	112,7	111,6	110,3	109,0	107,6	105,7	104,5	101,9	97,5	94,1	89,9	81,6	72,1	66,7	48,9	34,0		G1"½	G1"¼	702	25,0

MODEL	CODE	ELECTRICAL DATA				HYDRAULIC DATA																	DNA GAS	DNM GAS	H mm	WEIGHT Kg	
		VOLTAGE 50 Hz	P2 NOMINAL		In A	MOTOR TYPE	Q=m³h	Q=l/min																			
			kW	HP				0	0,6	1,2	1,8	2,4	3	3,3	3,9	4,8	5,4	6	7,2	8,4	9	10,8					12
KVC 50-30 T	60183598	3 x 230 / 400 V ~	0,75	1	4,2-2,5	IE2	61,5	59,9	56,8	52,2	46,0	38,0	33,5	22,7										1"¼	1"¼	652	17,5
KVC 60-30 T	60183418	3 x 230 / 400 V ~	0,8	1,1	4,4-2,6	IE2	69,6	67,6	64,0	58,5	51,1	41,8	36,2	23,8										1"¼	1"¼	652	17,3
KVC 65-30 T	60183419	3 x 230 / 400 V ~	1	1,36	5-2,9	IE2	78,4	76,8	73,5	68,4	61,2	51,9	46,0	33,3										1"¼	1"¼	679	18,5
KVC 40-50 T	60145303	3 x 230 / 400 V ~	0,8	1,1	3,8-2,2	IE2	54,9	53,7	52,0	49,7	46,3	42,1	39,6	33,7	22,9									1"¼	1"¼	505	15,8
KVC 55-50 T	60145304	3 x 230 / 400 V ~	1	1,36	4,4-2,6	IE2	68,6	67,1	65,0	62,1	57,9	52,7	49,5	42,1	28,6									1"¼	1"¼	533	17,0
KVC 65-50 T	60145878	3 x 230 / 400 V ~	1,1	1,5	7-4	IE2	82,3	80,6	78,0	74,6	69,4	63,2	59,4	50,6	34,3									1"¼	1"¼	600	19,8
KVC 75-50 T	60145879	3 x 230 / 400 V ~	1,5	2	7,7-4,3	IE2	96,0	94,0	91,0	87,0	81,0	73,8	69,3	59,0	40,0									1"¼	1"¼	627	20,6
KVC 30/80 T	60183406	3 x 230 / 400 V ~	1,1	1,36	4,4-2,5	IE2	36,9	36,9	36,6	36,1	35,3	34,3	33,6	32,2	29,5	27,8	25,5	20,3	14,2	10,7				G1"½	G1"¼	505	13,9
KVC 40/80 T	60183407	3 x 230 / 400 V ~	1,1	1,5	5,2-3	IE2	50,1	49,7	49,0	48,0	46,7	45,1	44,2	42	38,5	35,7	32,5	25,5	17,1	12,5				G1"½	G1"¼	560	17,6
KVC 45/80 T	60183408	3 x 230 / 400 V ~	1,6	2,2	7-4	IE2	64,6	64,5	63,9	63,0	61,7	60,0	59,0	56,7	52,5	49,3	45	37,1	26,8	21,1				G1"½	G1"¼	634	17,6
KVC 55/80 T	60183409	3 x 230 / 400 V ~	1,65	2,5	7,8-4,5	IE2	76,1	75,8	75,1	73,9	72,2	70,0	68,5	66	60,5	56,7	52	41,8	29,5	22,7				G1"½	G1"¼	727	22,1
KVC 65/80 T	60183410	3 x 230 / 400 V ~	2,2	3	8,5-4,9	IE2	88,6	88,0	86,9	85,5	83,5	81,2	80,0	76,5	71	67,0	62	51,1	37,9	30,5				G1"½	G1"¼	727	22,1
KVC 25-120 T	60145816	3 x 230 / 400 V ~	1	1,36	5-2,9	IE2	30,4	30,3	30,2	30,0	29,9	29,6	29,3	28,7	27,7	26,9	25,9	23,2	19,9	18,2	12,0	7,0		G1"½	G1"¼	450	17,1
KVC 35-120 T	60145817	3 x 230 / 400 V ~	1,1	1,5	6-3,5	IE2	46,2	46,1	45,7	45,3	44,8	44,0	43,7	42,7	40,9	39,3	37,4	33,7	29,4	26,8	18,0	11,0		G1"½	G1"¼	480	20,2
KVC 45-120 T	60145960	3 x 230 / 400 V ~	1,85	2,5	7,9-4,6	IE2	62,4	62,0	61,4	60,8	60,1	59,1	58,6	57,5	55,3	53,4	51,4	46,2	40,6	37,5	26,3	17,0		G1"½	G1"¼	507	21,9
KVC 60-120 T	60145961	3 x 230 / 400 V ~	2,2	3	9,3-5,4	IE2	78,0	77,5	76,7	75,9	75,1	73,9	73,3	71,5	68,3	65,9	63,2	58,0	51,0	47	35,0	24,5		G1"½	G1"¼	610	21,6
KVC 70-120 T	60146006	3 x 230 / 400 V ~	3	4	11,8-6,8	IE2	95,0	94,3	93,4	92,5	91,4	89,8	88,9	86,8	83,2	80,5	77,9	71,7	63,9	59,2	44,0	31,0		G1"½	G1"¼	675	24,0
KVC 85-120 T	60146007	3 x 230 / 400 V ~	3	4	13,5-7,8	IE2	112,7	111,6	110,3	109,0	107,6	105,7	104,5	101,9	97,5	94,1	89,9	81,6	72,1	66,7	48,9	34,0		G1"½	G1"¼	702	25,0

# KVC / KVCX

MULTISTAGE CENTRIFUGAL PUMPS WITH VERTICAL AXIS



IE3  $\geq 0,75$  kW

IE2  $\geq 0,75$  kW

**EXTRA EU**

## KVCX

MODEL	CODE	ELECTRICAL DATA				MOT. TYPE	Q=m <sup>3</sup> /h	HYDRAULIC DATA																			DNA GAS	DNM GAS	H mm	Weight Kg
		VOLTAGE 50 Hz	P2 NOMINAL		In A			Q=l/min	0	0,6	1,2	1,8	2,4	3	3,3	3,9	4,8	5,4	6	7,2	8,4	9	10,8	12						
KVCX 15-30 M	60183573	1 x 220 - 240V ~	0,25	0,33	2,8	-	21,5	21,3	20,5	19,0	16,9	14,2	12,6	8,9										1" 1/4	1" 1/4	505	14,7			
KVCX 15-30 T	60183575	3 x 230 / 400V ~	0,25	0,33	2,3-1,3	-	21,5	21,3	20,5	19,0	16,9	14,2	12,6	8,9											1" 1/4	1" 1/4	505	14,7		
KVCX 25-30 M	60183576	1 x 220 - 240V ~	0,37	0,5	3,4	-	29,0	28,6	27,4	25,3	22,4	18,5	16,3	10,7											1" 1/4	1" 1/4	505	14,7		
KVCX 25-30 T	60183577	3 x 230 / 400V ~	0,37	0,5	1,5-2,5	-	29,0	28,6	27,4	25,3	22,4	18,5	16,3	10,7											1" 1/4	1" 1/4	505	14,7		
KVCX 35-30 M	60183578	1 x 220 - 240V ~	0,45	0,6	4,1	-	40,2	39,3	37,3	34,1	29,8	24,3	21,0	13,5											1" 1/4	1" 1/4	560	14,5		
KVCX 35-30 T	60183579	3 x 230 / 400V ~	0,45	0,6	2,8-1,6	-	40,2	39,3	37,3	34,1	29,8	24,3	21,0	13,5											1" 1/4	1" 1/4	560	14,5		
KVCX 45-30 M	60183580	1 x 220 - 240V ~	0,75	1,0	5,2	-	49,7	48,7	46,5	43,1	38,4	32,1	28,5	19,6											1" 1/4	1" 1/4	560	14,9		
KVCX 45-30 T	60183581	3 x 230 / 400V ~	0,55	0,75	3-1,7	-	47,1	45,9	43,5	39,8	34,7	28,0	24,0	14,7											1" 1/4	1" 1/4	560	14,9		
KVCX 50-30 M	60183582	1 x 220 - 240V ~	0,75	1,0	6	-	61,5	59,9	56,8	52,2	46,0	38,0	33,5	22,7											1" 1/4	1" 1/4	652	17,5		
KVCX 50-30 T	60183588	3 x 230 / 400V ~	0,75	1,0	3,7-2,2	IE3	61,5	59,9	56,8	52,2	46,0	38,0	33,5	22,7											1" 1/4	1" 1/4	652	17,5		
KVCX 60-30 M	60183584	1 x 220 - 240V ~	1,0	1,36	6,7	-	69,6	67,6	64,0	58,5	51,1	41,8	36,2	23,8											1" 1/4	1" 1/4	652	17,3		
KVCX 60-30 T	60183589	3 x 230 / 400V ~	0,8	1,1	3,9-2,3	IE3	69,6	67,6	64,0	58,5	51,1	41,8	36,2	23,8											1" 1/4	1" 1/4	652	17,3		
KVCX 65-30 M	60183586	1 x 220 - 240V ~	1	1,36	7,3	-	78,4	76,8	73,5	68,4	61,2	51,9	46,0	33,3											1" 1/4	1" 1/4	679	18,9		
KVCX 65-30 T	60183590	3 x 230 / 400V ~	1	1,36	4,4-2,6	IE3	78,4	76,8	73,5	68,4	61,2	51,9	46,0	33,3											1" 1/4	1" 1/4	679	18,5		
KVCX 20-50 M	102980360	1 x 220 - 240 V ~	0,37	0,5	2,5	-	27,4	26,9	26,0	24,9	23,1	21,1	19,8	16,9	11,4										1" 1/4	1" 1/4	450	13,5		
KVCX 20-50 T	102980370	3 x 230 / 400 V ~	0,37	0,5	1,7-1,0	-	27,4	26,9	26,0	24,9	23,1	21,1	19,8	16,9	11,4										1" 1/4	1" 1/4	450	13,5		
KVCX 30-50 M	102980100	1 x 220 - 240 V ~	0,55	0,75	4	-	41,1	40,3	39,0	37,3	34,7	31,6	29,7	25,3	17,1										1" 1/4	1" 1/4	478	13,7		
KVCX 30-50 T	102980110	3 x 230 / 400 V ~	0,55	0,75	2,4-1,4	-	41,1	40,3	39,0	37,3	34,7	31,6	29,7	25,3	17,1										1" 1/4	1" 1/4	478	13,7		
KVCX 40-50 M	102980120	1 x 220 - 240 V ~	0,8	1,1	5,6	-	54,9	53,7	52,0	49,7	46,3	42,1	39,6	33,7	22,9										1" 1/4	1" 1/4	505	15,8		
KVCX 40-50 T	60179402	3 x 230 / 400 V ~	0,8	1,1	4,1-2,4	IE3	54,9	53,7	52,0	49,7	46,3	42,1	39,6	33,7	22,9										1" 1/4	1" 1/4	505	15,8		
KVCX 55-50 M	102980140	1 x 220 - 240 V ~	1	1,36	6,4	-	68,6	67,1	65,0	62,1	57,9	52,7	49,5	42,1	28,6										1" 1/4	1" 1/4	533	17,0		
KVCX 55-50 T	60179403	3 x 230 / 400 V ~	1	1,36	4,7-2,7	IE3	68,6	67,1	65,0	62,1	57,9	52,7	49,5	42,1	28,6										1" 1/4	1" 1/4	533	17,0		
KVCX 65-50 M	102980160	1 x 220 - 240 V ~	1,1	1,5	7,4	-	82,3	80,6	78,0	74,6	69,4	63,2	59,4	50,6	34,3										1" 1/4	1" 1/4	600	20,2		
KVCX 65-50 T	60179919	3 x 230 / 400 V ~	1,1	1,5	5,9-3,4	IE3	82,3	80,6	78,0	74,6	69,4	63,2	59,4	50,6	34,3										1" 1/4	1" 1/4	600	19,8		
KVCX 75-50 M	102980180	1 x 220 - 240 V ~	1,5	2	9	-	96,0	94,0	91,0	87,0	81,0	73,8	69,3	59,0	40,0										1" 1/4	1" 1/4	627	21,2		
KVCX 75-50 T	60179917	3 x 230 / 400 V ~	1,5	2	6,6-3,8	IE3	96,0	94,0	91,0	87,0	81,0	73,8	69,3	59,0	40,0										1" 1/4	1" 1/4	627	20,6		
KVCX 20-80 M	60183676	1 x 220 - 240V ~	0,55	0,75	4,2	-	25,0	24,8	24,4	23,8	23,1	22,3	21,5	20,5	19	17,3	16	11,9	7,4	4,8				G1" 1/4	G1" 1/4	505	14,7			
KVCX 20-80 T	60183677	3 x 230 / 400V ~	0,55	0,75	2,8-1,6	-	25,0	24,8	24,4	23,8	23,1	22,3	21,5	20,5	19	17,3	16	11,9	7,4	4,8				G1" 1/4	G1" 1/4	505	14,7			
KVCX 30-80 M	60183678	1 x 220 - 240V ~	1	1,36	6,5	-	36,9	36,9	36,6	36,1	35,3	34,3	33,6	32,2	29,5	27,8	25,5	20,3	14,2	10,7				G1" 1/4	G1" 1/4	505	13,7			
KVCX 30-80 T	60183812	3 x 230 / 400V ~	1	1,36	3,8-2,2	IE3	36,9	36,9	36,6	36,1	35,3	34,3	33,6	32,2	29,5	27,8	25,5	20,3	14,2	10,7				G1" 1/4	G1" 1/4	505	13,9			
KVCX 40-80 M	60183680	1 x 220 - 240V ~	1,1	1,5	7,4	-	50,1	49,7	49,0	48,0	46,7	45,1	44,2	42	38,5	35,7	32,5	25,5	17,1	12,5				G1" 1/4	G1" 1/4	560	18			
KVCX 40-80 T	60183795	3 x 230 / 400V ~	1,1	1,5	4,5-2,6	IE3	50,1	49,7	49,0	48,0	46,7	45,1	44,2	42	38,5	35,7	32,5	25,5	17,1	12,5				G1" 1/4	G1" 1/4	560	17,6			
KVCX 45-80 M	60183682	1 x 220 - 240V ~	1,6	2,2	9,6	-	64,6	64,5	63,9	63,0	61,7	60,0	59,0	56,7	52,5	49,3	45	37,1	26,8	21,1				G1" 1/4	G1" 1/4	634	18			
KVCX 45-80 T	60183796	3 x 230 / 400V ~	1,6	2,2	6-3,4	IE3	64,6	64,5	63,9	63,0	61,7	60,0	59,0	56,7	52,5	49,3	45	37,1	26,8	21,1				G1" 1/4	G1" 1/4	634	17,6			
KVCX 55-80 M	60183684	1 x 220 - 240V ~	1,85	2,5	11,2	-	76,1	75,8	75,1	73,9	72,2	70,0	68,5	66	60,5	56,7	52	41,8	29,5	22,7				G1" 1/4	G1" 1/4	727	22			
KVCX 55-80 T	60183797	3 x 230 / 400V ~	1,85	2,5	6,8-3,9	IE3	76,1	75,8	75,1	73,9	72,2	70,0	68,5	66	60,5	56,7	52	41,8	29,5	22,7				G1" 1/4	G1" 1/4	727	22,1			
KVCX 65-80 T	60183798	3 x 230 / 400V ~	2,2	3	7,7-4,4	-	88,6	88,0	86,9	85,5	83,5	81,2	80,0	76,5	71	67,0	62	51,1	37,9	30,5				G1" 1/4	G1" 1/4	727	22,1			
KVCX 25-120 M	102980400	1 x 220 - 240 V ~	1	1,36	6,5	-	30,4	30,3	30,2	30,0	29,9	29,6	29,3	28,7	27,7	26,9	25,9	23,2	19,9	18,2	12,0	7,0			G1" 1/4	G1" 1/4	450	17,0		
KVCX 25-120 T	60179880	3 x 230 / 400 V ~	1	1,36	5-2,9	IE3	30,4	30,3	30,2	30,0	29,9	29,6	29,3	28,7	27,7	26,9	25,9	23,2	19,9	18,2	12,0	7,0			G1" 1/4	G1" 1/4	450	17,1		
KVCX 35-120 M	102980420	1 x 220 - 240 V ~	1,1	1,5	7,4	-	46,2	46,1	45,7	45,3	44,8	44,0	43,7	42,7	40,9	39,3	37,4	33,7	29,4	26,8	18,0	11,0			G1" 1/4	G1" 1/4	480	20,1		
KVCX 35-120 T	60179866	3 x 230 / 400 V ~	1,1	1,5	6,4-3,7	IE3	46,2	46,1	45,7	45,3	44,8	44,0	43,7	42,7	40,9	39,3	37,4	33,7	29,4	26,8	18,0	11,0			G1" 1/4	G1" 1/4	480	20,2		
KVCX 45-120 M	102980440	1 x 220 - 240 V ~	1,85	2,5	12	-	62,4	62,0	61,4	60,8	60,1	59,1	58,6	57,5	55,3	53,4	51,4	46,2	40,6	37,5	26,3	17,0			G1" 1/4	G1" 1/4	507	20,2		
KVCX 45-120 T	60179376	3 x 230 / 400 V ~	1,85	2,5	7,6-4,4	-	62,4	62,0	61,4	60,8	60,1	59,1	58,6	57,5	55,3	53,4	51,4	46,2	40,6	37,5	26,3	17,0			G1" 1/4	G1" 1/4	507	21,9		
KVCX 60-120 T	60179856	3 x 230 / 400 V ~	2,2	3	9-5,2	IE3	78,0	77,5	76,7	75,9	75,1	73,9	73,3	71,5	68,3	65,9	63,2	58,0	51,0	47	35,0	24,5			G1" 1/4	G1" 1/4	610	21,6		
KVCX 70-120 T	60179871	3 x 230 / 400 V ~	3	4	10,9-6,3	-	95,0	94,3	93,4	92,5	91,4	89,8	88,9	86,8	83,2	80,5	77,9	71,7	63,9	59,2	44,0	31,0			G1" 1/4	G1" 1/4	675	24,0		
KVCX 85-120 T	60179860	3 x 230 / 400 V ~	3	4	12,3-7,1	-	112,7	111,6	110,3	109,0	107,6	105,7	104,5	101																

# KVC / KVCX

MULTISTAGE CENTRIFUGAL PUMPS WITH VERTICAL AXIS



IE3 ≥ 0,75 kW

IE2 ≥ 0,75 kW

EXTRA EU

## KVCX

MODEL	CODE	ELECTRICAL DATA				HYDRAULIC DATA																			DNA GAS	DNM GAS	H mm	Weight Kg							
		P2 NOMINAL		In A	MOT. TYPE	Q=m³h	0	0,6	1,2	1,8	2,4	3	3,3	3,9	4,8	5,4	6	7,2	8,4	9	10,8	12													
		kW	HP			Q=l/min	0	10	20	30	40	50	55	65	80	90	100	120	140	150	180	200													
KVCX 50/30 T	60183583	3 x 230 / 400 V ~	0,75	1	4,2-2,5	IE2	H (m)	61,5	59,9	56,8	52,2	46,0	38,0	33,5	22,7														1"¼	1"¼	652	17,5			
KVCX 60/30 T	60183585	3 x 230 / 400 V ~	0,8	1,1	4,4-2,6			69,6	67,6	64,0	58,5	51,1	41,8	36,2	23,8															1"¼	1"¼	652	17,3		
KVCX 65/30 T	60183587	3 x 230 / 400 V ~	1	1,36	5-2,9			78,4	76,8	73,5	68,4	61,2	51,9	46,0	33,3															1"¼	1"¼	679	18,5		
KVCX 40-50 T	60145293	3 x 230 / 400 V ~	0,8	1,1	3,8-2,2			54,9	53,7	52,0	49,7	46,3	42,1	39,6	33,7	22,9															1"¼	1"¼	505	15,8	
KVCX 55-50 T	60145295	3 x 230 / 400 V ~	1	1,36	4,4-2,6			68,6	67,1	65,0	62,1	57,9	52,7	49,5	42,1	28,6															1"¼	1"¼	533	17,0	
KVCX 65-50 T	60145869	3 x 230 / 400 V ~	1,1	1,5	7-4			82,3	80,6	78,0	74,6	69,4	63,2	59,4	50,6	34,3															1"¼	1"¼	600	19,8	
KVCX 75-50 T	60145871	3 x 230 / 400 V ~	1,5	2	7,7-4,3			96,0	94,0	91,0	87,0	81,0	73,8	69,3	59,0	40,0															1"¼	1"¼	627	20,6	
KVCX 30/80 T	60183679	3 x 230 / 400 V ~	1	1,36	4,4-2,5			36,9	36,9	36,6	36,1	35,3	34,3	33,6	32,2	29,5	27,8	25,5	20,3	14,2	10,7									G 1"¼	G 1"¼	505	13,9		
KVCX 40/80 T	60183681	3 x 230 / 400 V ~	1,1	1,5	5,2-3			50,1	49,7	49,0	48,0	46,7	45,1	44,2	42	38,5	35,7	32,5	25,5	17,1	12,5										G 1"¼	G 1"¼	560	17,6	
KVCX 45/80 T	60183683	3 x 230 / 400 V ~	1,6	2,2	7-4			64,6	64,5	63,9	63,0	61,7	60,0	59,0	56,7	52,5	49,3	45	37,1	26,8	21,1										G 1"¼	G 1"¼	634	17,6	
KVCX 55/80 T	60183685	3 x 230 / 400 V ~	1,85	2,5	7,8-4,5			76,1	75,8	75,1	73,9	72,2	70,0	68,5	66	60,5	56,7	52	41,8	29,5	22,7											G 1"¼	G 1"¼	727	22,1
KVCX 65/80 T	60183686	3 x 230 / 400 V ~	2,2	3	8,5-4,9			88,6	88,0	86,9	85,5	83,5	81,2	80,0	76,5	71	67,0	62	51,1	37,9	30,5											G 1"¼	G 1"¼	727	22,1
KVCX 25-120 T	60145811	3 x 230 / 400 V ~	1	1,36	5-2,9			30,4	30,3	30,2	30,0	29,9	29,6	29,3	28,7	27,7	26,9	25,9	23,2	19,9		12,0	7,0								G 1"¼	G 1"¼	450	17,1	
KVCX 35-120 T	60145813	3 x 230 / 400 V ~	1,1	1,5	6-3,5			46,2	46,1	45,7	45,3	44,8	44,0	43,7	42,7	40,9	39,3	37,4	33,7	29,4		18,0	11,0								G 1"¼	G 1"¼	480	20,2	
KVCX 45-120 T	60145949	3 x 230 / 400 V ~	1,85	2,5	7,9-4,6			62,4	62,0	61,4	60,8	60,1	59,1	58,6	57,5	55,3	53,4	51,4	46,2	40,6		26,3	17,0								G 1"¼	G 1"¼	507	21,9	
KVCX 60-120 T	60145952	3 x 230 / 400 V ~	2,2	3	9,3-5,4			78,0	77,5	76,7	75,9	75,1	73,9	73,3	71,5	68,3	65,9	63,2	58,0	51,0		35,0	24,5								G 1"¼	G 1"¼	610	21,6	
KVCX 70-120 T	60146000	3 x 230 / 400 V ~	3	4	11,8-6,8			95,0	94,3	93,4	92,5	91,4	89,8	88,9	86,8	83,2	80,5	77,9	71,7	63,9		44,0	31,0								G 1"¼	G 1"¼	675	24,0	
KVCX 85-120 T	60146002	3 x 230 / 400 V ~	3	4	13,5-7,8			112,7	111,6	110,3	109,0	107,6	105,7	104,5	101,9	97,5	94,1	89,9	81,6	72,1		48,9	34,0								G 1"¼	G 1"¼	702	25,0	

COMMAND AND CONTROL SYSTEMS

CIRCULATORS AND IN-LINE PUMPS

MULTISTAGE CENTRIFUGAL AND SELF-PRIMING PUMPS

SWIMMING POOL, POND AND SALT WATER PUMPS

CENTRIFUGAL PUMPS

SUBMERSIBLE PUMPS

SUBMERSIBLE PUMPS AND SUBMERSIBLE MOTORS

PRESSURE UNITS

# NKV 1-3-6-10-15-20 S

MULTISTAGE CENTRIFUGAL PUMPS WITH VERTICAL AXIS



DAB's new NKV S pumps are AISI 304 stainless steel multi-impeller vertical centrifugal pumps with coupling; designed for pressurisation in civil and commercial environments, they can also be used in agriculture, in watering systems.

The pumps can be used for the recirculation of water in heating and air conditioning systems.

In all models, the parts in contact with the liquid are made of AISI 304 stainless steel (AISI 316 stainless steel, X version, only on request).

They are particularly versatile, thanks to the centre distance between the 2 in-line ports, designed to maximise interchangeability. Starting from 5.5 kW models, the silicon carbide-graphite mechanical seal can be removed without removing the motor.

Mechanical seals for aggressive liquids and different connections (round, oval, Victaulic, clamp flanges) available on request.

All the models are WRAS and ACS certified for use with drinking water.

Rigid coupling to IE3 high energy efficiency electric motors.

**Operating range**

1 m<sup>3</sup>/h to 30 m<sup>3</sup>/h with head up to 320 m

**Pumped liquid** Clean, free of solids and abrasives, non-viscous, non-aggressive, non-crystallised and chemically neutral

**Maximum glycol content** 30%

**Supported liquid temperature**

-30 °C to +120 °C (EPDM)

-15 °C to +120 °C (Viton/FKM)

**Maximum ambient temperature** +50° C

**Maximum operating pressure bar / kPa**

25 bar / 2500 kPa

**Motor protection class** IP 55

**Motor insulation class** F

**Impeller/s material**

AISI 304 stainless steel for NKV S

AISI 316 stainless steel for NKV X (only on request)

**Single-phase power supply**

Contact our sales network

**Three phase power input**

220 - 240 / 380 - 415 V at 50 Hz, up to 2.2 kW

380 - 415 V at 50 Hz, 3 kW

**Possible type of installation** Vertical position

**Special versions on request**

Available with different types of mechanical seals for aggressive liquids and connections (round, oval, Victaulic, clamp flanges), **with parts in contact with the liquid in AISI 316 stainless steel (X versions)**, other voltages and frequencies, ATEX version



IE3 ≥ 0,75 kW

ACCESSORIES  
PAG. 207



**HIGH EFFICIENCY**

The new NKV pumps are supplied with IE3 class motors and comply with the highest energy efficiency standards on the water handling market.

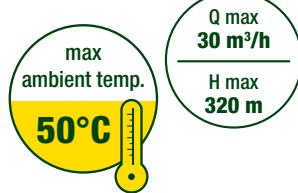

**PERFORMANCE FOR EVERY NEED**

They offer incredible application flexibility thanks to a complete performance range and the ability to work with ambient temperatures up to 50°C.



**ROBUSTNESS AND RELIABILITY**

All parts in contact with liquids are made of AISI 304 stainless steel (AISI 316 X versions). DAB construction quality guarantees solidity and greater resistance to wear and tear.

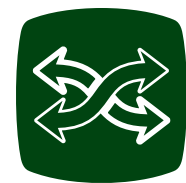

**THE EASIEST REPLACEMENT EVER**

In addition, the new range has been designed to simplify replacement thanks to the standard flanges and standard centre distances.

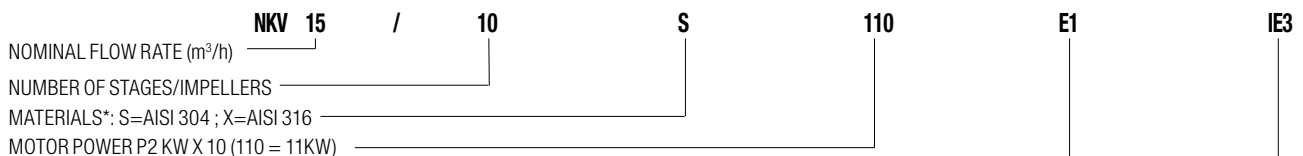

**Type of mechanical seal (E1=STANDARD)**

- E1=BQGE=Carbon/Silicon carbide/AISI 316/EPDM
- E2=QQGE=Silicon Carbide/Silicon Carbide/AISI 316/EPDM
- V3=QQGV=Silicon Carbide/Silicon Carbide/AISI 316/FKM-Viton
- V4=BQGV= Carbon/Silicon carbide /AISI 316/ FKM-Viton
- E5=UUGE=Tungsten carbide/Tungsten carbide/AISI 316/EPDM

Motor efficiency ————

\*MATERIALS:

“S” version with pump body/impellers/diffusers in AISI 304 stainless steel

“X” versione con corpo pompa/giranti/diffusori in acciaio inox AISI 316

# NKV 1-3-6-10-15-20 S

MULTISTAGE CENTRIFUGAL PUMPS WITH VERTICAL AXIS



## NKV 1 S

MODEL	CODE	ELECTRICAL DATA				HYDRAULIC DATA							DNA	DNM	H mm	CENTRE DISTANCE mm	WEIGHT Kg
		VOLTAGE 50 Hz	P2 NOMINAL		In A	Q=m³/h	0	0.5	1	1.5	2	2.5					
			kW	HP		Q=l/min	0	8.3	16.7	25.0	33.3	42					
NKV 1/2 S T	60190159	3 x 220-240 /380-415Y	0,37	0,50	1,7/1,0	H (m)	14.5	13.5	12.5	11.5	9.5	7.5	25	25	529	250	17,3
NKV 1/3 S T	60187823	3 x 220-240 /380-415Y	0,37	0,50	1,7/1,0		21.5	20,0	19,0	17,0	14,0	11,0	25	25	552	250	17,8
NKV 1/4 S T	60190293	3 x 220-240 /380-415Y	0,37	0,50	1,7/1,0		28,0	26,5	24,5	22,0	18,5	14,0	25	25	574	250	18,3
NKV 1/5 S T	60187914	3 x 220-240 /380-415Y	0,37	0,50	1,7/1,0		35,0	33,0	30,5	27,0	22,5	17,0	25	25	597	250	18,8
NKV 1/6 S T	60188596	3 x 220-240 /380-415Y	0,37	0,50	1,7/1,0		41,5	39,0	36,0	32,0	26,5	19,5	25	25	619	250	19,3
NKV 1/7 S T	60189235	3 x 220-240 /380-415Y	0,37	0,50	1,7/1,0		48,0	45,0	41,5	36,5	30,0	22,0	25	25	642	250	19,8
NKV 1/8 S T	60190164	3 x 220-240 /380-415Y	0,55	0,75	2,7/1,6		55,0	52,0	48,0	42,5	35,0	26,0	25	25	664	250	20,7
NKV 1/9 S T	60190295	3 x 220-240 /380-415Y	0,55	0,75	2,7/1,6		61,5	58,0	53,0	47,0	39,0	28,5	25	25	687	250	21,2
NKV 1/10 S T	60190296	3 x 220-240 /380-415Y	0,55	0,75	2,7/1,6		68,0	64,0	58,5	51,5	43,0	31,5	25	25	709	250	21,7
NKV 1/11 S T	60190297	3 x 220-240 /380-415Y	0,55	0,75	2,7/1,6		74,5	69,5	64,0	56,5	46,5	34,0	25	25	732	250	22,2
NKV 1/12 S T	60190298	3 x 220-240 /380-415Y	0,75	1,00	3,9/1,7		83,0	78,5	72,0	64,0	53,0	39,5	25	25	770	250	26,0
NKV 1/13 S T	60190299	3 x 220-240 /380-415Y	0,75	1,00	3,9/1,7		89,5	84,5	77,5	68,5	57,0	42,0	25	25	793	250	26,5
NKV 1/14 S T	60188895	3 x 220-240 /380-415Y	0,75	1,00	3,9/1,7		96,0	90,5	83,0	73,0	60,5	44,5	25	25	815	250	26,5
NKV 1/15 S T	60190300	3 x 220-240 /380-415Y	0,75	1,00	3,9/1,7		102,5	96,0	88,0	78,0	64,0	47,0	25	25	838	250	27,0
NKV 1/17 S T	60190301	3 x 220-240 /380-415Y	1,10	1,50	4,1/2,4		118,0	111,5	103,0	91,5	76,0	56,5	25	25	883	250	29,6
NKV 1/19 S T	60190302	3 x 220-240 /380-415Y	1,10	1,50	4,1/2,4		131,0	123,5	114,0	101,0	84,0	62,0	25	25	928	250	30,6
NKV 1/22 S T	60190199	3 x 220-240 /380-415Y	1,10	1,50	4,1/2,4		150,5	141,5	130,0	115,0	95,0	69,5	25	25	995	250	32,1
NKV 1/23 S T	60190303	3 x 220-240 /380-415Y	1,50	2,00	5,1/3,0		160,5	152,0	140,0	124,5	104,0	77,5	25	25	1063	250	36,0
NKV 1/25 S T	60190304	3 x 220-240 /380-415Y	1,50	2,00	5,1/3,0		174,0	164,0	151,5	134,5	112,0	83,5	25	25	1108	250	37,0
NKV 1/27 S T	60190305	3 x 220-240 /380-415Y	1,50	2,00	5,1/3,0		187,0	176,5	162,5	144,0	120,0	88,5	25	25	1153	250	38,0
NKV 1/30 S T	60190306	3 x 220-240 /380-415Y	1,50	2,00	5,1/3,0	206,5	194,5	179,0	158,0	131,0	96,5	25	25	1220	250	39,0	
NKV 1/32 S T	60190307	3 x 220-240 /380-415Y	2,20	3,00	7,8-4,6	224,5	213,0	197,0	175,5	147,5	110,5	25	25	1265	250	42,0	
NKV 1/34 S T	60190308	3 x 220-240 /380-415Y	2,20	3,00	7,8-4,6	238,0	225,5	208,5	185,5	155,5	116,5	25	25	1310	250	43,0	
NKV 1/37 S T	60190309	3 x 220-240 /380-415Y	2,20	3,00	7,8-4,6	258,0	244,0	225,5	200,5	167,5	125,0	25	25	1378	250	44,5	



# NKV 1-3-6-10-15-20 S

MULTISTAGE CENTRIFUGAL PUMPS WITH VERTICAL AXIS



## NKV 3 S

MODEL	CODE	ELECTRICAL DATA				HYDRAULIC DATA													DNA	DNM	H mm	CENTRE DISTANCE mm	WEIGHT Kg
		VOLTAGE 50 Hz	P2 NOMINAL		In A	Q=m³/h																	
			kW	HP		0	1	1.5	2	2.5	3	3.5	4	4.5	0	16.7	25.0	33.3					
NKV 3/2 S T	60190310	3 x 220-240 /380-415Y	0,37	0,50	1,7/1,0	15,0	15,0	14,5	13,5	12,5	11,5	10,0	8,0	6,0	25	25	529	250	17,3				
NKV 3/3 S T	60189097	3 x 220-240 /380-415Y	0,37	0,50	1,7/1,0	22,5	22,0	21,0	20,0	18,5	17,0	14,5	12,0	8,5	25	25	552	250	17,8				
NKV 3/4 S T	60189488	3 x 220-240 /380-415Y	0,37	0,50	1,7/1,0	30,0	28,5	27,5	26,0	24,0	21,5	18,5	15,0	10,5	25	25	574	250	18,3				
NKV 3/5 S T	60190311	3 x 220-240 /380-415Y	0,55	0,75	2,7/1,6	37,5	36,0	34,5	32,5	30,0	27,0	23,5	18,5	13,0	25	25	597	250	19,2				
NKV 3/6 S T	60190312	3 x 220-240 /380-415Y	0,55	0,75	2,7/1,6	44,5	42,5	40,5	38,5	35,5	32,0	27,0	21,5	15,0	25	25	619	250	19,7				
NKV 3/7 S T	60190313	3 x 220-240 /380-415Y	0,75	1,00	3,9/1,7	52,5	50,5	48,5	46,0	43,0	38,5	33,0	26,5	19,0	25	25	658	250	23,5				
NKV 3/8 S T	60188597	3 x 220-240 /380-415Y	0,75	1,00	3,9/1,7	59,5	57,5	55,0	52,0	48,0	43,5	37,0	29,5	21,0	25	25	680	250	24,0				
NKV 3/9 S T	60187822	3 x 220-240 /380-415Y	0,75	1,00	3,9/1,7	67,0	64,0	61,5	58,0	53,5	48,0	41,0	32,5	22,5	25	25	703	250	24,5				
NKV 3/10 S T	60190314	3 x 220-240 /380-415Y	1,10	1,50	4,1/2,4	75,0	72,5	70,0	66,5	61,5	55,5	48,0	38,5	27,5	25	25	725	250	26,6				
NKV 3/11 S T	60190315	3 x 220-240 /380-415Y	1,10	1,50	4,1/2,4	82,5	79,5	76,5	72,5	67,0	60,5	52,0	42,0	29,5	25	25	748	250	27,1				
NKV 3/12 S T	60190316	3 x 220-240 /380-415Y	1,10	1,50	4,1/2,4	89,5	86,0	83,0	78,5	72,5	65,0	56,0	45,0	31,5	25	25	770	250	27,6				
NKV 3/13 S T	60190317	3 x 220-240 /380-415Y	1,10	1,50	4,1/2,4	96,5	93,0	89,0	84,5	78,0	70,0	60,0	47,5	33,5	25	25	793	250	28,1				
NKV 3/14 S T	60190318	3 x 220-240 /380-415Y	1,50	2,00	5,1/3,0	105,5	102,0	98,5	93,5	86,5	78,0	67,5	54,5	39,5	25	25	860	250	32,0				
NKV 3/15 S T	60190319	3 x 220-240 /380-415Y	1,50	2,00	5,1/3,0	112,5	109,0	105,0	99,5	92,5	83,0	71,5	58,0	41,5	25	25	883	250	32,5				
NKV 3/16 S T	60190320	3 x 220-240 /380-415Y	1,50	2,00	5,1/3,0	120,0	115,5	111,5	105,5	98,0	88,0	76,0	61,0	43,5	25	25	905	250	32,5				
NKV 3/17 S T	60190321	3 x 220-240 /380-415Y	1,50	2,00	5,1/3,0	127,0	122,5	118,0	111,5	103,5	93,0	80,0	64,0	45,5	25	25	928	250	33,0				
NKV 3/18 S T	60190322	3 x 220-240 /380-415Y	2,20	3,00	7,8-4,6	136,5	132,5	128,0	121,5	113,5	102,5	89,0	72,5	53,0	25	25	950	250	35,5				
NKV 3/19 S T	60190323	3 x 220-240 /380-415Y	2,20	3,00	7,8-4,6	144,0	139,5	134,5	128,0	119,0	107,5	93,5	76,0	55,5	25	25	973	250	36,0				
NKV 3/21 S T	60190324	3 x 220-240 /380-415Y	2,20	3,00	7,8-4,6	158,5	153,5	148,0	140,5	130,5	118,0	102,0	83,0	60,0	25	25	1018	250	37,0				
NKV 3/23 S T	60190325	3 x 220-240 /380-415Y	2,20	3,00	7,8-4,6	173,0	167,5	161,5	153,0	142,0	128,0	110,5	89,5	64,5	25	25	1063	250	38,0				
NKV 3/25 S T	60190326	3 x 220-240 /380-415Y	2,20	3,00	7,8-4,6	187,5	181,0	174,5	165,5	153,5	138,0	119,0	96,0	68,5	25	25	1108	250	39,0				
NKV 3/27 S T	60190327	3 x 380-415	3,00	4,00	5,6	205,5	199,5	193,0	184,0	171,5	155,0	135,0	110,5	81,0	25	25	1202	250	47,3				
NKV 3/29 S T	60190328	3 x 380-415	3,00	4,00	5,6	220,0	213,5	206,5	196,5	183,5	166,0	144,0	117,5	86,0	25	25	1247	250	48,3				
NKV 3/31 S T	60190329	3 x 380-415	3,00	4,00	5,6	235,0	228,0	220,5	209,5	195,0	176,5	153,0	124,5	91,0	25	25	1292	250	49,3				
NKV 3/33 S T	60190330	3 x 380-415	3,00	4,00	5,6	249,5	242,0	234,0	222,0	206,5	187,0	162,0	131,5	95,5	25	25	1337	250	50,3				

# NKV 1-3-6-10-15-20 S

MULTISTAGE CENTRIFUGAL PUMPS WITH VERTICAL AXIS



## NKV 6 S

MODEL	CODE	ELECTRICAL DATA			HYDRAULIC DATA											DNA	DNM	H mm	CENTRE DISTANCE mm	WEIGHT Kg
		VOLTAGE 50 Hz	P2 NOMINAL		In A	Q=m³/h	0	3	3.5	4	4.5	5	5.4	6	7					
			kW	HP		Q=l/min	0	50.0	58.3	67	75.0	83.3	90	100.0	116.7					
NKV 6/2 S T	60190333	3 x 220-240 /380-415Y	0,37	0,50	1,7/1,0	15,0	13,5	13,0	12,5	12,0	11,5	11,0	10,0	8,0	32	32	536	250	17,8	
NKV 6/3 S T	60190334	3 x 220-240 /380-415Y	0,37	0,50	1,7/1,0	22,5	19,5	19,0	18,0	17,0	16,0	15,5	14,0	11,0	32	32	562	250	18,3	
NKV 6/4 S T	60190335	3 x 220-240 /380-415Y	0,55	0,75	2,7/1,6	29,5	26,0	25,0	24,0	22,5	21,5	20,5	18,5	14,5	32	32	588	250	19,2	
NKV 6/5 S T	60188893	3 x 220-240 /380-415Y	0,75	1,00	3,9/1,7	37,5	33,5	32,0	30,5	29,0	27,5	26,0	24,0	19,0	32	32	630	250	23,0	
NKV 6/6 S T	60190336	3 x 220-240 /380-415Y	0,75	1,00	3,9/1,7	44,5	39,5	37,5	36,0	34,0	32,5	30,5	28,0	22,0	32	32	656	250	23,5	
NKV 6/7 S T	60190337	3 x 220-240 /380-415Y	1,10	1,50	4,1/2,4	52,5	47,0	45,0	43,0	41,0	39,0	37,0	34,0	27,0	32	32	682	250	25,6	
NKV 6/8 S T	60190338	3 x 220-240 /380-415Y	1,10	1,50	4,1/2,4	59,5	53,5	51,0	48,5	46,5	44,0	42,0	38,5	30,5	32	32	708	250	26,1	
NKV 6/9 S T	60190339	3 x 220-240 /380-415Y	1,10	1,50	4,1/2,4	67,0	59,0	56,5	54,0	51,5	48,5	46,0	42,5	33,5	32	32	734	250	26,6	
NKV 6/10 S T	60190161	3 x 220-240 /380-415Y	1,50	2,00	5,1/3,0	75,0	67,5	65,0	62,0	59,0	56,0	53,5	49,0	39,0	32	32	805	250	30,5	
NKV 6/11 S T	60190340	3 x 220-240 /380-415Y	1,50	2,00	5,1/3,0	82,5	73,5	71,0	67,5	64,5	61,0	58,0	53,5	42,5	32	32	831	250	31,5	
NKV 6/12 S T	60190341	3 x 220-240 /380-415Y	1,50	2,00	5,1/3,0	89,5	80,0	76,5	73,0	69,5	65,5	62,5	57,5	45,5	32	32	857	250	32,0	
NKV 6/13 S T	60190357	3 x 220-240 /380-415Y	1,50	2,00	5,1/3,0	97,0	86,0	82,0	78,5	74,5	70,5	67,0	61,5	48,5	32	32	883	250	32,5	
NKV 6/14 S T	60190342	3 x 220-240 /380-415Y	2,20	3,00	7,8-4,6	105,5	95,5	92,0	88,0	83,5	79,5	76,0	70,0	56,0	32	32	909	250	35,0	
NKV 6/15 S T	60190344	3 x 220-240 /380-415Y	2,20	3,00	7,8-4,6	113,0	102,0	98,0	93,5	89,0	84,5	80,5	74,0	59,5	32	32	935	250	35,5	
NKV 6/16 S T	60190345	3 x 220-240 /380-415Y	2,20	3,00	7,8-4,6	120,5	108,0	104,0	99,0	94,5	89,5	85,5	78,5	62,5	32	32	961	250	36,0	
NKV 6/17 S T	60190346	3 x 220-240 /380-415Y	2,20	3,00	7,8-4,6	127,5	114,5	109,5	105,0	99,5	94,5	90,0	83,0	66,0	32	32	987	250	36,5	
NKV 6/18 S T	60190347	3 x 220-240 /380-415Y	2,20	3,00	7,8-4,6	135,0	120,5	115,5	110,5	105,0	99,5	94,5	87,0	69,0	32	32	1013	250	37,0	
NKV 6/19 S T	60190348	3 x 220-240 /380-415Y	2,20	3,00	7,8-4,6	142,0	126,5	121,5	115,5	110,0	104,0	99,0	91,0	72,0	32	32	1039	250	37,5	
NKV 6/20 S T	60190349	3 x 380-415	3,00	4,00	5,6	152,0	138,0	133,0	127,0	121,0	115,0	110,0	101,5	82,0	32	32	1114	250	45,3	
NKV 6/21 S T	60190350	3 x 380-415	3,00	4,00	5,6	159,0	144,5	139,0	133,0	127,0	120,5	115,0	106,0	85,5	32	32	1140	250	45,8	
NKV 6/23 S T	60190351	3 x 380-415	3,00	4,00	5,6	174,0	157,5	151,5	144,5	138,0	131,0	125,0	115,0	92,5	32	32	1192	250	46,8	
NKV 6/25 S T	60190352	3 x 380-415	3,00	4,00	5,6	189,0	170,0	164,0	157,5	150,5	142,5	135,5	123,5	98,5	32	32	1244	250	47,8	
NKV 6/28 S T	60190353	3 x 380-415	4,00	5,50	8	214,0	194,5	188,0	181,0	173,5	164,5	156,5	143,0	115,5	32	32	1322	250	53,0	
NKV 6/30 S T	60190354	3 x 380-415	4,00	5,50	8	229,0	207,5	200,5	193,0	184,5	175,5	167,0	152,5	122,5	32	32	1374	250	54,5	
NKV 6/33 S T	60190355	3 x 380-415	4,00	5,50	8	251,5	227,0	219,5	211,0	201,5	191,0	182,0	166,0	133,5	32	32	1452	250	56,0	
NKV 6/36 S T	60190356	3 x 380-415	5,50	7,50	10,2	275,0	249,5	241,5	232,5	222,5	211,5	201,5	184,0	148,5	32	32	1728	250	84,1	

D+CONNECT

COMMAND AND CONTROL SYSTEMS

CIRCULATORS AND IN-LINE PUMPS

MULTISTAGE CENTRIFUGAL AND SELF-PRIMING PUMPS

SWIMMING POOL, POND AND SALT WATER PUMPS

CENTRIFUGAL PUMPS

SUBMERSIBLE PUMPS

SUBMERSIBLE PUMPS AND SUBMERSIBLE MOTORS

PRESSURE UNITS

# NKV 1-3-6-10-15-20 S

MULTISTAGE CENTRIFUGAL PUMPS WITH VERTICAL AXIS



## NKV 10 S

MODEL	CODE	ELECTRICAL DATA			HYDRAULIC DATA														DNA	DNM	H mm	CENTRE DISTANCE mm	WEIGHT Kg
		VOLTAGE 50 Hz	P2 NOMINAL		In A	Q=m³/h	0	3	5	6	7	8	9	10	11	14							
			kW	HP		Q=l/min	0	50.0	83.3	100.0	116.7	133	150.0	166.7	183	233.3							
NKV 10/2 S T	60187831	3 x 220-240 /380-415V	0,75	1,00	3,9/1,7	H (m)	20,0	20,0	19,0	18,5	17,5	17,0	16,0	15,0	13,5	9,0	40	40	573	280	22,5		
NKV 10/3 S T	60190358	3 x 220-240 /380-415V	1,10	1,50	4,1/2,4		30,0	30,0	28,5	27,5	26,5	25,5	24,0	22,5	20,5	13,5	40	40	603	280	25,1		
NKV 10/4 S T	60190360	3 x 220-240 /380-415V	1,50	2,00	5,1/3,0		40,5	40,0	38,5	37,0	35,5	34,0	32,5	30,5	28,0	18,0	40	40	678	280	29,0		
NKV 10/5 S T	60187635	3 x 220-240 /380-415V	1,50	2,00	5,1/3,0		50,5	49,5	47,0	45,5	43,5	41,5	39,5	37,0	33,5	21,5	40	40	708	280	29,5		
NKV 10/6 S T	60187634	3 x 220-240 /380-415V	2,20	3,00	7,8-4,6		61,0	60,5	57,5	56,0	54,0	51,5	49,0	46,0	42,0	27,5	40	40	738	280	32,5		
NKV 10/7 S T	60187628	3 x 220-240 /380-415V	2,20	3,00	7,8-4,6		70,5	70,0	66,5	64,5	62,0	59,5	56,0	52,5	48,0	31,0	40	40	768	280	33,0		
NKV 10/8 S T	60190361	3 x 380-415	3,00	4,00	5,6		81,5	81,0	78,0	75,5	73,0	70,0	66,5	62,5	57,5	38,0	40	40	847	280	41,3		
NKV 10/9 S T	60187630	3 x 380-415	3,00	4,00	5,6		91,5	91,0	87,5	84,5	81,5	78,0	74,0	69,5	64,0	42,0	40	40	877	280	41,8		
NKV 10/10 S T	60190362	3 x 380-415	4,00	5,50	8		102,5	102,5	99,0	96,0	93,0	89,0	84,5	79,5	73,5	49,0	40	40	907	280	46,0		
NKV 10/11 S T	60190363	3 x 380-415	4,00	5,50	8		113,0	112,5	108,0	105,0	101,5	97,5	92,5	87,0	80,5	53,5	40	40	937	280	46,5		
NKV 10/12 S T	60187915	3 x 380-415	4,00	5,50	8		123,0	122,5	117,5	114,0	110,0	105,5	100,5	94,0	87,0	57,5	40	40	967	280	47,5		
NKV 10/13 S T	60190364	3 x 380-415	4,00	5,50	8		133,0	132,0	127,0	123,0	118,5	113,5	108,0	101,0	93,5	61,5	40	40	997	280	48,0		
NKV 10/15 S T	60185079	3 x 380-415	5,50	7,50	10,2		153,5	153,0	147,0	142,5	138,0	132,0	125,5	118,0	109,0	72,0	40	40	1254	280	76,1		
NKV 10/17 S T	60190365	3 x 380-415	5,50	7,50	10,2		173,5	172,5	165,5	160,5	155,0	148,5	141,0	132,5	122,0	80,5	40	40	1314	280	77,1		
NKV 10/19 S T	60185990	3 x 380-415	7,50	10,00	14,4		195,0	194,5	187,5	182,0	176,0	169,0	160,5	151,0	139,5	93,0	40	40	1396	280	81,0		
NKV 10/21 S T	60190366	3 x 380-415	7,50	10,00	14,4		215,5	214,5	206,0	200,0	193,5	185,5	176,5	166,0	153,0	101,5	40	40	1456	280	82,5		
NKV 10/23 S T	60190367	3 x 380-415	7,50	10,00	14,4		235,5	234,0	225,0	218,5	211,0	202,0	192,0	180,5	166,5	110,0	40	40	1516	280	83,5		
NKV 10/24 S T	60185989	3 x 380-415	11,00	15,00	19,7		248,0	247,0	240,5	234,0	227,0	218,0	208,0	196,0	182,0	122,5	40	40	1641	280	109,5		

## NKV 15 S

MODEL	CODE	ELECTRICAL DATA			HYDRAULIC DATA														DNA	DNM	H mm	CENTRE DISTANCE mm	WEIGHT Kg
		VOLTAGE 50 Hz	P2 NOMINAL		In A	Q=m³/h	0	8	10	12	14	16	18	20	22	24							
			kW	HP		Q=l/min	0	133	167	200	233	266	300	333	367	400							
NKV 15/1 S T	60190368	3 x 220-240 /380-415V	1,10	1,50	4,1/2,4	H (m)	14,5	13,0	12,5	12,0	11,5	10,5	9,5	8,5	7,0	5,5	50	50	633	300	30,6		
NKV 15/2 S T	60188235	3 x 220-240 /380-415V	2,20	3,00	7,8-4,6		29,0	26,0	25,0	24,0	23,0	21,5	19,5	17,0	14,0	11,0	50	50	678	300	37,0		
NKV 15/3 S T	60186454	3 x 380-415	3,00	4,00	5,6		43,5	39,0	38,0	36,5	34,5	32,5	29,5	26,0	21,5	17,0	50	50	775	300	45,8		
NKV 15/4 S T	60187689	3 x 380-415	4,00	5,50	8		58,0	52,5	51,0	49,0	46,5	44,0	40,5	35,5	29,5	23,5	50	50	823	300	51,0		
NKV 15/5 S T	60187690	3 x 380-415	4,00	5,50	8		72,5	65,5	63,5	60,5	57,5	54,5	49,5	43,0	36,0	28,5	50	50	871	300	52,5		
NKV 15/6 S T	60189196	3 x 380-415	5,50	7,50	10,2		87,5	79,5	77,0	74,0	71,0	67,0	61,5	54,0	46,0	36,5	50	50	1128	300	81,1		
NKV 15/7 S T	60185080	3 x 380-415	5,50	7,50	10,2		102,0	92,0	89,0	86,0	82,0	77,5	70,5	62,0	52,5	41,5	50	50	1176	300	82,6		
NKV 15/8 S T	60187692	3 x 380-415	7,50	10,00	14,4		117,0	106,5	103,0	99,5	95,0	90,0	82,5	72,5	62,0	49,0	50	50	1246	300	86,5		
NKV 15/9 S T	60190369	3 x 380-415	7,50	10,00	14,4		131,5	119,0	115,5	111,0	106,0	100,5	92,0	81,0	69,0	54,5	50	50	1294	300	88,0		
NKV 15/10 S T	60190370	3 x 380-415	11,00	15,00	19,7		147,5	134,5	131,0	126,5	121,0	115,0	106,0	94,0	80,5	65,0	50	50	1437	300	115,0		
NKV 15/11 S T	60190371	3 x 380-415	11,00	15,00	19,7		162,0	148,0	143,5	139,0	133,0	126,5	116,5	103,0	88,5	71,0	50	50	1485	300	116,5		
NKV 15/12 S T	60190372	3 x 380-415	11,00	15,00	19,7		176,5	161,0	156,5	151,0	144,5	137,5	126,5	112,0	96,0	77,0	50	50	1533	300	118,0		
NKV 15/13 S T	60190373	3 x 380-415	11,00	15,00	19,7		191,0	174,5	169,0	163,5	156,5	148,5	136,5	120,5	103,0	82,5	50	50	1581	300	119,5		
NKV 15/14 S T	60190374	3 x 380-415	11,00	15,00	19,7		205,5	187,5	182,0	175,5	168,0	159,0	146,0	129,0	110,5	88,0	50	50	1629	300	121,0		
NKV 15/15 S T	60190375	3 x 380-415	15,00	20,00	26,7		221,0	201,0	195,5	188,5	180,5	171,5	157,5	139,5	119,5	95,5	50	50	1728	300	131,0		
NKV 15/16 S T	60190376	3 x 380-415	15,00	20,00	26,7		235,5	214,0	208,0	200,5	192,0	182,5	167,5	148,0	126,5	101,5	50	50	1776	300	132,5		
NKV 15/17 S T	60190377	3 x 380-415	15,00	20,00	26,7		249,5	227,5	220,5	213,0	203,5	193,0	177,5	156,5	134,0	107,0	50	50	1824	300	134,0		

D+CONNECT  
 COMMAND AND CONTROL SYSTEMS  
 CIRCULATORS AND IN-LINE PUMPS  
 MULTISTAGE CENTRIFUGAL AND SELF-PRIMING PUMPS  
 SWIMMING POOL, POND AND SALT WATER PUMPS  
 CENTRIFUGAL PUMPS  
 SUBMERSIBLE PUMPS  
 SUBMERSIBLE PUMPS AND SUBMERSIBLE MOTORS  
 PRESSURE UNITS

# NKV 1-3-6-10-15-20 S

MULTISTAGE CENTRIFUGAL PUMPS WITH VERTICAL AXIS



## NKV 20 S

MODEL	CODE	ELECTRICAL DATA				HYDRAULIC DATA										DNA	DNM	H mm	CENTRE DISTANCE mm	WEIGHT Kg	
		VOLTAGE 50 Hz	P2 NOMINAL		In A	Q=m³/h	0	10	12	14	16	18	20	22	24						28
			kW	HP		Q=l/min	0	167	200	233	266	300	333	367	400						467
NKV 20/1 S T	60190378	3 x 220-240 /380-415Y	1,10	1,50	4,1/2,4	15,5	13,5	13,0	13,0	12,5	12,0	11,0	10,0	8,5	6,0	50	50	633	300	30,6	
NKV 20/2 S T	60190379	3 x 220-240 /380-415Y	2,20	3,00	7,8-4,6	31,0	27,5	27,0	26,0	25,0	24,0	22,5	20,5	18,0	12,0	50	50	678	300	37,0	
NKV 20/3 S T	60186460	3 x 380-415	3,00	4,00	5,6	46,5	41,5	40,5	39,5	38,0	36,5	34,5	31,0	27,5	18,5	50	50	775	300	45,8	
NKV 20/4 S T	60190380	3 x 380-415	4,00	5,50	8	62,5	56,0	55,0	53,5	51,5	49,5	46,5	42,5	37,0	25,5	50	50	823	300	51,0	
NKV 20/5 S T	60190381	3 x 380-415	5,50	7,50	10,2	78,0	70,0	68,5	66,5	64,5	62,0	58,0	53,0	47,0	32,5	50	50	1080	300	80,1	
NKV 20/6 S T	60187641	3 x 380-415	7,50	10,00	14,4	94,5	86,5	84,5	82,5	80,0	77,5	73,5	67,5	60,0	42,5	50	50	1150	300	84,0	
NKV 20/7 S T	60187642	3 x 380-415	7,50	10,00	14,4	110,0	100,5	98,0	95,5	93,0	90,0	85,0	77,5	69,0	48,5	50	50	1198	300	85,0	
NKV 20/8 S T	60190382	3 x 380-415	11,00	15,00	19,7	126,5	117,0	114,0	112,0	109,0	106,0	100,5	92,5	82,5	59,5	50	50	1341	300	112,5	
NKV 20/9 S T	60187643	3 x 380-415	11,00	15,00	19,7	142,5	131,0	128,0	125,5	122,0	118,5	112,5	103,5	92,5	66,5	50	50	1389	300	114,0	
NKV 20/10 S T	60190383	3 x 380-415	11,00	15,00	19,7	158,0	145,5	142,0	139,0	135,0	131,5	124,5	114,0	102,0	73,0	50	50	1437	300	115,0	
NKV 20/11 S T	60190384	3 x 380-415	15,00	20,00	26,7	174,0	160,0	156,5	153,0	149,0	144,5	137,0	126,0	113,0	81,0	50	50	1536	300	125,5	
NKV 20/12 S T	60190385	3 x 380-415	15,00	20,00	26,7	189,5	174,5	170,5	167,0	162,0	157,5	149,0	137,0	122,5	87,5	50	50	1584	300	127,0	
NKV 20/13 S T	60190386	3 x 380-415	15,00	20,00	26,7	205,0	188,5	184,0	180,0	175,0	170,0	161,0	147,5	132,0	94,0	50	50	1632	300	128,5	
NKV 20/14 S T	60190387	3 x 380-415	15,00	20,00	26,7	220,5	202,5	198,0	193,5	188,0	182,5	172,5	158,0	141,0	100,5	50	50	1680	300	130,0	
NKV 20/15 S T	60190388	3 x 380-415	18,50	25,00	33	237,0	217,5	212,5	208,0	202,0	196,0	185,5	170,5	152,0	108,5	50	50	1794	300	167,0	
NKV 20/16 S T	60190389	3 x 380-415	18,50	25,00	33	252,5	231,5	226,0	221,0	215,0	208,5	197,0	181,0	161,5	115,0	50	50	1842	300	168,5	
NKV 20/17 S T	60190390	3 x 380-415	18,50	25,00	33	268,0	245,5	240,0	234,5	227,5	221,0	209,0	191,5	171,0	121,5	50	50	1890	300	170,0	

## SPECIAL VERSION

### VERSION WITH SPECIAL MECHANICAL SEALS

- <sup>(1)</sup> Mech. seal SPECIAL type E2 = SIC - SIC - EPDM = Silicon Carbide/Silicon Carbide/AISI 316/EPDM
- <sup>(2)</sup> Mech. seal SPECIAL type V3 = SIC - SIC - VITON = Silicon Carbide/Silicon Carbide/AISI 316/FKM
- <sup>(3)</sup> Mech. seal SPECIAL type V4 = SIC - CAR - VITON = Silicon Carbide/Carbon/AISI 316/FKM
- <sup>(4)</sup> Mech. seal SPECIAL type E5 = WC - WC - EPDM = Tungsten Carbide/Tungsten Carbide/AISI 316/EPDM

# NKV 32-45-65-95

MULTISTAGE CENTRIFUGAL PUMPS WITH VERTICAL AXIS



DAB's NKV 32, 45, 65, 95 pumps are multi-impeller vertical centrifugal pumps with coupling; designed for pressurisation in civil and commercial environments, they can also be used in agriculture, for the distribution of liquids and in watering systems.

The pumps can be used for the recirculation of water in heating and air conditioning systems.

Pump body and upper flange in cathophoretic paint coated cast iron; impellers, diffusers and pump liner made of AISI 304 stainless steel (AISI 316 stainless steel available on request - X version).

They are particularly versatile, thanks to the centre distance between the 2 in-line ports, designed to maximise interchangeability. Starting from 5.5 kW models, the silicon carbide-graphite mechanical seal can be removed without removing the motor.

Mechanical seals for aggressive liquids and different connections (round, oval, Victaulic, clamp flanges) available on request.

All the AISI 316 stainless steel - X version - models are certified for use with drinking water (WRAS and ACS certified).

Rigid coupling to IE3 high energy efficiency electric motors.

**Operating range**

1 m<sup>3</sup>/h to 120 m<sup>3</sup>/h with head up to 320 m

**Pumped liquid** Clean, free of solids and abrasives, non-viscous, non-aggressive, non-crystallised and chemically neutral

**Maximum glycol content** 30%

**Supported liquid temperature**

-30 °C to +120 °C (EPDM)  
-15 °C to +120 °C (Viton/FKM)

**Maximum ambient temperature** +50° C

**Maximum operating pressure bar / kPa**

NKV 65, 95: 25 bar / 2500 kPa  
NKV 32, 45: 32 bar / 3200 kPa

**Motor protection class** IP 55

**Motor insulation class** F

**Impeller/s material**

AISI 304 stainless steel  
AISI 316 for NKV X only on request

**Single-phase power supply**

Contact our sales network

**Three phase power input**

220 - 240 / 380 - 415 V at 50 Hz, up to 2.2 kW  
380 - 415 V at 50 Hz, 3 kW

**Special versions on request**

Yes, available with different types of mechanical seals for aggressive liquids and connections (round, oval, Victaulic, clamp flanges), **with parts in contact with the liquid in AISI 316 stainless steel (X versions)**, other voltages and frequencies, ATEX version.



IE3 ≥ 0,75 kW

ACCESSORIES  
PAG. 207

	NKV 32	/	13	-	2	X	300	E1	IE3
NOMINAL FLOW RATE (m <sup>3</sup> /h)									
NUMBER OF STAGES/IMPELLERS									
NUMBER AND TYPE OF TURNED IMPELLER									
MATERIALS*: " " =CAST IRON/AISI 304; X=AISI 316									
MOTOR POWER P2 KW X 10 (300 = 30KW)									
<b>Type of mechanical seal (E1=STANDARD)</b>									
E1=BQGE=Carbon/Silicon carbide/AISI 316/EPDM STD									
E2=QQGE=Silicon Carbide/Silicon Carbide/AISI 316/EPDM									
V3=QQGV=Silicon Carbide/Silicon Carbide/AISI 316/FKM-Viton									
V4=BQGV= Carbon/Silicon carbide /AISI 316/ FKM-Viton									
E5=UUGE=Tungsten carbide/Tungsten carbide/AISI 316/EPDM									
Motor efficiency									
*MATERIALS:									
"X" version with pump body/impellers/diffusers in AISI 316 stainless steel									
" " standard version with pump body in cast iron and impellers in AISI 304 stainless steel (for NKV 32-45-65-95)									

# NKV 32-45-65-95

MULTISTAGE CENTRIFUGAL PUMPS WITH VERTICAL AXIS



## NKV 32

MODEL	CODE	ELECTRICAL DATA				HYDRAULIC DATA													DNA	DNM	H mm	CENTRE DISTANCE mm	WEIGHT Kg
		VOLTAGE 50 Hz	P2 NOMINAL		In A	Q=m³/h	0	15	18	22	25	30	35	40	45								
			KW	HP			Q=l/min	0	250	300	367	417	500	583	667	750							
NKV 32/2-2 T	60180195	3 x 380-415	4,0	5,5	8	H (m)	36,0	33,5	32,5	30,5	29,5	27	22,5	18,0	12,5	65	65	947	320	93			
NKV 32/2 T	60180196	3 x 380-415	5,5	7,5	10,2		48,5	43,5	42,5	41,0	39,5	36,5	33,5	29,0	23,5	65	65	1114	320	140			
NKV 32/3-2 T	60180197	3 x 380-415	5,5	7,5	10,2		60,0	54,5	53,0	50,5	48,0	44,0	38,0	31,5	23,5	65	65	1196	320	144			
NKV 32/3 T	60167525	3 x 380-415	7,5	10,0	14,4		73,0	65,0	63,5	61,0	59,0	55,0	50,0	43,5	35,5	65	65	1243	320	125			
NKV 32/4-2 T	60167526	3 x 380-415	7,5	10,0	14,4		84,5	76,5	74,0	70,5	68,0	62,0	55,0	46,0	35,0	65	65	1325	320	132			
NKV 32/4 T	60167527	3 x 380-415	11,0	15,0	19,7		98,0	88,0	86,0	83,0	80,5	75,0	69,0	60,0	49,5	65	65	1345	320	203			
NKV 32/5-2 T	60167528	3 x 380-415	11,0	15,0	19,7		109,5	99,5	97,0	93,0	89,5	83,0	74,0	63,0	49,5	65	65	1427	320	207			
NKV 32/5 T	60167529	3 x 380-415	15,0	20,0	26,7		122,5	109,5	107,0	103,5	100,0	93,5	85,5	75,0	61,5	65	65	1495	320	214			
NKV 32/6-2 T	60167530	3 x 380-415	15,0	20,0	26,7		134,0	121,5	118,5	113,5	109,5	101,5	91,0	78,0	61,5	65	65	1577	320	218			
NKV 32/6 T	60167531	3 x 380-415	15,0	20,0	26,7		146,5	131,0	128,0	123,5	119,5	111,5	102,0	89,0	73,0	65	65	1577	320	218			
NKV 32/7-2 T	60167532	3 x 380-415	15,0	20,0	26,7		158,0	142,5	139,0	133,5	128,5	119,0	107,0	91,5	72,5	65	65	1659	320	222			
NKV 32/7 T	60167533	3 x 380-415	18,5	25,0	33		171,0	152,5	149,0	144,0	139,5	130,0	119,0	103,5	85,0	65	65	1703	320	243			
NKV 32/8-2 T	60167534	3 x 380-415	18,5	25,0	33		182,5	164,5	160,0	154,0	148,5	137,5	124,0	106,0	84,5	65	65	1785	320	247			
NKV 32/8 T	60167535	3 x 380-415	18,5	25,0	33		194,5	174,0	169,5	164,0	158,5	147,5	134,5	117,0	95,5	65	65	1785	320	247			
NKV 32/9-2 T	60167536	3 x 380-415	22,0	30,0	38,1		208,5	188,5	184,0	177,0	171,0	159,0	144,0	124,5	100,5	65	65	1898	320	283			
NKV 32/9 T	60167537	3 x 380-415	22,0	30,0	38,1		221,0	198,0	194,0	187,5	181,5	169,5	155,5	136,0	112,0	65	65	1898	320	283			
NKV 32/10-2 T	60167538	3 x 380-415	22,0	30,0	38,1		233,0	210,0	205,0	197,5	191,0	177,5	161,0	139,0	112,0	65	65	1980	320	290			
NKV 32/10 T	60167539	3 x 380-415	30,0	40,0	52,1		246,5	221,5	217,0	210,0	203,5	190,5	175,0	153,5	126,5	65	65	2075	320	363			
NKV 32/11-2 T	60167540	3 x 380-415	30,0	40,0	52,1		258,0	233,5	228,5	220,5	213,0	198,5	180,5	156,5	127,0	65	65	2157	320	367			
NKV 32/11 T	60167541	3 x 380-415	30,0	40,0	52,1		271,0	243,5	238,0	230,5	223,5	209,0	192,0	168,0	138,5	65	65	2157	320	367			
NKV 32/12-2 T	60167542	3 x 380-415	30,0	40,0	52,1	282,5	255,5	249,5	241,0	233,0	217,0	197,5	171,0	139,0	65	65	2239	320	371				
NKV 32/12 T	60167543	3 x 380-415	30,0	40,0	52,1	295,0	265,5	259,5	251,0	243,0	227,5	208,5	182,5	150,5	65	65	2239	320	371				
NKV 32/13-2 T	60167544	3 x 380-415	30,0	40,0	52,1	307,0	277,5	271,0	261,5	252,5	235,5	214,0	185,5	151,0	65	65	2321	320	375				
NKV 32/13 T	60167545	3 x 380-415	30,0	40,0	52,1	319,5	287,0	280,5	271,5	263,0	246,0	225,5	197,0	162,5	65	65	2321	320	375				

COMMAND AND CONTROL SYSTEMS

CIRCULATORS AND IN-LINE PUMPS

MULTISTAGE CENTRIFUGAL AND SELF-PRIMING PUMPS

SWIMMING POOL, POND AND SALT WATER PUMPS

CENTRIFUGAL PUMPS

SUBMERSIBLE PUMPS

SUBMERSIBLE PUMPS AND SUBMERSIBLE MOTORS

PRESSURE UNITS

# NKV 32-45-65-95

MULTISTAGE CENTRIFUGAL PUMPS WITH VERTICAL AXIS



## NKV 45

MODEL	CODE	ELECTRICAL DATA				HYDRAULIC DATA											DNA	DNM	H mm	CENTRE DISTANCE mm	WEIGHT Kg
		VOLTAGE 50 Hz	P2 NOMINAL		In A	Q=m³/h	0	18	25	30	40	54	60	65	70						
			kW	HP		Q=l/min	0	300	417	500	667	900	1000	1083	1166						
NKV 45/2-2 T	60180198	3 x 380-415	5,5	7,5	10,2	38,5	37,0	35,5	34,5	31,0	23	18,5	14,5	10,0	80	80	1149	365	146		
NKV 45/2 T	60167546	3 x 380-415	7,5	10,0	14,4	48,5	47,0	45,5	44,0	41,5	34,0	30,5	26,5	23,0	80	80	1196	365	127		
NKV 45/3-2 T	60167547	3 x 380-415	11,0	15,0	19,7	63,0	61,5	59,5	58,0	53,5	42,0	36,0	30,0	24,0	80	80	1298	365	205		
NKV 45/3 T	60167548	3 x 380-415	11,0	15,0	19,7	73,5	71,0	69,0	67,0	63,0	52,5	47,0	41,0	34,0	80	80	1298	365	205		
NKV 45/4-2 T	60167549	3 x 380-415	15,0	20,0	26,7	87,5	85,0	82,0	80,0	74,0	59,5	51,0	43,0	34,0	80	80	1448	365	216		
NKV 45/4 T	60167550	3 x 380-415	15,0	20,0	26,7	97,5	94,5	91,5	89,0	84,0	69,5	62,0	54,5	45,0	80	80	1448	365	216		
NKV 45/5-2 T	60167551	3 x 380-415	18,5	25,0	33	112,0	108,5	105,0	102,0	94,5	76,5	66,0	56,0	45,0	80	80	1574	365	241		
NKV 45/5 T	60167552	3 x 380-415	18,5	25,0	33	122,0	118,0	114,0	111,0	104,5	86,5	77,0	67,5	56,0	80	80	1574	365	241		
NKV 45/6-2 T	60167553	3 x 380-415	22,0	30,0	38,1	137,5	133,5	129,0	126,0	117,5	95,5	83,5	72,0	58,0	80	80	1687	365	276		
NKV 45/6 T	60167554	3 x 380-415	22,0	30,0	38,1	147,5	143,5	138,5	135,0	127,0	106,0	95,0	83,5	71,0	80	80	1687	365	276		
NKV 45/7-2 T	60167555	3 x 380-415	30,0	40,0	52,1	162,5	158,0	153,0	149,5	139,5	115,0	101,0	87,5	73,0	80	80	1864	365	356		
NKV 45/7 T	60167556	3 x 380-415	30,0	40,0	52,1	172,5	168,0	162,5	158,5	149,5	125,5	112,0	99,0	83,0	80	80	1864	365	356		
NKV 45/8-2 T	60167557	3 x 380-415	30,0	40,0	52,1	187,0	182,0	176,0	171,5	160,5	132,0	116,5	101,0	83,0	80	80	1946	365	360		
NKV 45/8 T	60167558	3 x 380-415	30,0	40,0	52,1	197,0	191,5	185,5	181,0	170,5	142,5	127,5	112,5	94,0	80	80	1946	365	360		
NKV 45/9-2 T	60167559	3 x 380-415	37,0	50,0	62,6	211,5	205,5	199,0	194,0	181,5	149,5	132,0	114,5	94,0	80	80	2028	365	384		
NKV 45/9 T	60167560	3 x 380-415	37,0	50,0	62,6	221,5	215,5	208,0	203,0	191,5	160,0	143,0	126,0	106,0	80	80	2028	365	384		
NKV 45/10-2 T	60167561	3 x 380-415	37,0	50,0	62,6	235,5	229,0	221,5	216,0	202,0	166,5	147,0	127,5	106,0	80	80	2110	365	388		
NKV 45/10 T	60167562	3 x 380-415	37,0	50,0	62,6	246,0	239,0	230,5	225,0	212,0	177,0	158,0	139,0	117,0	80	80	2110	365	388		
NKV 45/11-2 T	60167563	3 x 380-415	45,0	60,0	78,4	261,0	254,0	245,5	239,5	224,5	186,0	164,5	143,5	119,0	80	80	2232	365	449		
NKV 45/11 T	60167564	3 x 380-415	45,0	60,0	78,4	271,0	263,5	255,0	249,0	234,5	196,5	175,5	155,0	130,0	80	80	2232	365	449		
NKV 45/12-2 T	60167565	3 x 380-415	45,0	60,0	78,4	285,5	277,5	268,5	261,5	245,5	203,0	179,5	156,5	130,0	80	80	2314	365	453		
NKV 45/12 T	60167566	3 x 380-415	45,0	60,0	78,4	295,5	287,5	277,5	271,0	255,5	213,5	191,0	168,5	142,0	80	80	2314	365	453		
NKV 45/13-2 T	60167567	3 x 380-415	45,0	60,0	78,4	309,5	301,0	291,0	284,0	266,0	220,5	195,0	170,0	142,0	80	80	2396	365	457		

# NKV 32-45-65-95

MULTISTAGE CENTRIFUGAL PUMPS WITH VERTICAL AXIS



## NKV 65

MODEL	CODE	ELECTRICAL DATA				HYDRAULIC DATA											DNA	DNM	H mm	CENTRE DISTANCE mm	WEIGHT Kg
		VOLTAGE 50 Hz		P2 NOMINAL		In A	Q=m³/h	0	30	42	45	54	60	72	78	85					
		kW	HP	Q=l/min	0		500	700	750	900	1000	1200	1300	1417							
NKV 65/2-2 T	60168471	3 x 380-415	7,5	10,0	14,4	H (m)	39,0	37,5	35,5	35,0	33,0	31	25,0	22,0	17,5	100	100	1266	365	84	
NKV 65/2 T	60168472	3 x 380-415	11,0	15,0	19,7		56,5	51,0	48,5	48,0	46,0	45,0	41,0	38,5	34,5	100	100	1354	365	155	
NKV 65/3-2 T	60168473	3 x 380-415	15,0	20,0	26,7		67,5	63,5	60,5	59,5	56,5	54,0	46,5	42,0	35,5	100	100	1446	365	171	
NKV 65/3 T	60168474	3 x 380-415	18,5	25,0	33		84,5	76,0	72,5	71,5	69,0	67,0	61,5	57,5	51,5	100	100	1490	365	213	
NKV 65/4-2 T	60168475	3 x 380-415	18,5	25,0	33		95,5	88,5	84,0	83,0	79,0	75,5	66,0	60,5	52,0	100	100	1582	365	213	
NKV 65/4 T	60168476	3 x 380-415	22,0	30,0	38,1		113,5	102,5	97,5	96,5	92,5	90,5	83,0	78,0	70,0	100	100	1613	365	255	
NKV 65/5-2 T	60168477	3 x 380-415	30,0	40,0	52,1		125,0	116,0	110,5	109,0	104,5	101,0	90,0	83,0	72,5	100	100	1801	365	471	
NKV 65/5 T	60168478	3 x 380-415	30,0	40,0	52,1		142,0	129,0	122,5	121,0	116,5	114,0	105,0	98,5	88,5	100	100	1801	365	471	
NKV 65/6-2 T	60168479	3 x 380-415	30,0	40,0	52,1		153,0	141,5	134,5	133,0	127,5	123,0	110,0	102,0	89,5	100	100	1893	365	471	
NKV 65/6 T	60168480	3 x 380-415	37,0	50,0	62,6		170,0	154,0	147,0	145,0	139,5	136,0	125,0	117,5	105,5	100	100	1893	365	517	
NKV 65/7-2 T	60168481	3 x 380-415	37,0	50,0	62,6		181,5	166,5	158,5	156,5	150,0	145,0	130,5	120,5	106,5	100	100	1985	365	517	
NKV 65/7 T	60168482	3 x 380-415	45,0	60,0	78,4		199,0	180,5	172,0	169,5	163,5	159,5	147,0	138,0	124,0	100	100	2025	365	653	
NKV 65/8-2 T	60168483	3 x 380-415	45,0	60,0	78,4		210,0	193,0	184,0	181,5	174,0	168,5	152,0	141,5	125,0	100	100	2117	365	653	
NKV 65/8 T	60168484	3 x 380-415	45,0	60,0	78,4		227,0	206,0	196,0	193,5	186,0	181,5	167,0	157,0	141,0	100	100	2117	365	653	

## NKV 95

MODEL	CODE	ELECTRICAL DATA				HYDRAULIC DATA											DNA	DNM	H mm	CENTRE DISTANCE mm	WEIGHT Kg
		VOLTAGE 50 Hz		P2 NOMINAL		In A	Q=m³/h	0	45	60	72	78	85	96	108	118					
		kW	HP	Q=l/min	0		750	1000	1200	1300	1417	1600	1800	1967							
NKV 95/2-2 T	60168485	3 x 380-415	11,0	15,0	19,7	H (m)	44,5	43,0	41,0	38,5	36,5	34	28,5	21,5	15,0	100	100	1354	380	186	
NKV 95/2 T	60168486	3 x 380-415	15,0	20,0	26,7		62,0	55,5	51,5	49,0	47,5	45,0	41,0	35,0	28,5	100	100	1354	380	196	
NKV 95/3-2 T	60168487	3 x 380-415	18,5	25,0	33		75,5	70,5	66,5	62,5	59,5	56,0	48,5	38,5	28,5	100	100	1490	380	217	
NKV 95/3 T	60168488	3 x 380-415	22,0	30,0	38,1		93,5	84,0	78,0	74,0	72,0	69,0	62,5	53,5	44,0	100	100	1521	380	238	
NKV 95/4-2 T	60168489	3 x 380-415	30,0	40,0	52,1		108,0	100,0	94,5	89,0	85,5	81,0	71,5	59,0	46,0	100	100	1708	380	343	
NKV 95/4 T	60168490	3 x 380-415	30,0	40,0	52,1		125,5	112,5	105,0	99,5	96,5	92,5	84,0	72,0	60,0	100	100	1708	380	343	
NKV 95/5-2 T	60168491	3 x 380-415	37,0	50,0	62,6		139,0	127,5	120,0	113,5	109,0	103,5	92,0	76,0	60,0	100	100	1801	380	379	
NKV 95/5 T	60168492	3 x 380-415	37,0	50,0	62,6		156,0	140,0	130,5	123,5	120,0	114,5	104,5	89,0	74,0	100	100	1801	380	379	
NKV 95/6-2 T	60168493	3 x 380-415	45,0	60,0	78,4		170,5	156,0	146,5	138,5	134,0	127,0	113,5	94,5	75,5	100	100	1933	380	455	
NKV 95/6 T	60168494	3 x 380-415	45,0	60,0	78,4		188,0	169,0	157,0	149,0	144,5	138,5	126,0	108,0	89,5	100	100	1933	380	455	

## SPECIAL VERSION

### VERSION WITH SPECIAL MECHANICAL SEALS

- (1) Ten. Mecc. SPECIALE tipo E2 = SIC - SIC - EPDM = Carbuco Silicio/Carbuco Silicio/AISI 316/EPDM
- (2) Ten. Mecc. SPECIALE tipo V3 = SIC - SIC - VITON = Carbuco Silicio/Carbuco Silicio/AISI 316/FKM
- (3) Ten. Mecc. SPECIALE tipo V4 = SIC - CAR - VITON = Carbuco Silicio/Carbone/AISI 316/FKM
- (4) Ten. Mecc. SPECIALE tipo E5 = WC - WC - EPDM = Carbuco Tungsteno/Carbuco Tungsteno/AISI 316/EPDM



# CENTRIFUGAL PUMPS ACCESSORIES

---

# ACCESSORIES

## CENTRIFUGAL PUMPS

COUNTERFLANGE KIT	MODEL	CODE	COUNTERFLANGES AND SEALS	THREADED	MATERIAL	PN	NKM-GE - NKP-GE NKM-G- NKP-G	KDNE - KDN
 <p>DN 32</p>	DN 32	109620520	1 x DN 32 + 1 x DN 50	THREADED	GALVANIZED STEEL	16	•	•
	DN 40	109620530	1 x DN 40 + 1 x DN 65	THREADED	GALVANIZED STEEL	16	•	•
	DN 50	109620540	1 x DN 50 + 1 x DN 65	THREADED	GALVANIZED STEEL	16	•	•
	DN 65	109620550	1 x DN 65 + 1 x DN 80	THREADED	GALVANIZED STEEL	16	•	•
	DN 32	109620400	1 x DN 32 + 1 x DN 50	TO BE WELDED	GALVANIZED STEEL	16	•	•
	DN 40	109620410	1 x DN 40 + 1 x DN 65	TO BE WELDED	GALVANIZED STEEL	16	•	•
	DN 50	109620420	1 x DN 50 + 1 x DN 65	TO BE WELDED	GALVANIZED STEEL	16	•	•
	DN 50/1	60115139	1 x DN 50 + 1 x DN 80	TO BE WELDED	GALVANIZED STEEL	16		•
	DN 65	109620430	1 x DN 65 + 1 x DN 80	TO BE WELDED	GALVANIZED STEEL	16	•	•
	DN 65/1	60115140	1 x DN 65 + 1 x DN 100	TO BE WELDED	GALVANIZED STEEL	16		•
	DN 80	109620440	1 x DN 80 + 1 x DN 100	TO BE WELDED	GALVANIZED STEEL	16	•	•
	DN 80/1	60115141	1 x DN 80 + 1 x DN 125	TO BE WELDED	GALVANIZED STEEL	16		•
	DN 100	109620450	1 x DN 100 + 1 x DN 125	TO BE WELDED	GALVANIZED STEEL	16	•	•
	DN 125	109620460	1 x DN 125 + 1 x DN 150	TO BE WELDED	GALVANIZED STEEL	16	•	•
	DN 150	109620470	1 x DN 150 + 1 x DN 200	TO BE WELDED	GALVANIZED STEEL	16 (10 x DN 200)	•	•
	DN 200	109620480	1 x DN 200 + 1 x DN 250	TO BE WELDED	GALVANIZED STEEL	16 (10 x DN 200)		•
	DN 250/1	109620500	1 x DN 250 + 1 x DN 300	TO BE WELDED	GALVANIZED STEEL	16		•
DN 300	109620510	1 x DN 300 + 1 x DN 350	TO BE WELDED	GALVANIZED STEEL	16		•	
DN 350	60115142	1 x DN 350 + 1 x DN 400	TO BE WELDED	GALVANIZED STEEL	16		•	

The kit comprises suction and delivery counterflanges with the relative seals, screws and nuts required by the size of the pump to which it refers.

COUNTERFLANGE KIT	MODEL	CODE	COUNTERFLANGES AND SEALS	THREADED	MATERIAL	PN	NKV / NKVE 1-3	NKV / NKVE 6	NKV / NKVE 10	NKV / NKVE 15-20	NKV / NKVE 32	NKV / NKVE 45	NKV / NKVE 65 - 95
 <p>DN 40</p>	DN 25x1"	60197941	2 x DN 25	THREADED	AISI 304 STAINLESS STEEL	25	•						
	DN 32x1" ¼	60197942	2 x DN 32	THREADED	AISI 304 STAINLESS STEEL	25		•					
	DN 40x1" ½	60197927	2 x DN 40	THREADED	AISI 304 STAINLESS STEEL	25			•				
	DN 40x1" ½	60119214	2 x DN 40	THREADED	GALVANIZED STEEL	40			•				
	DN 50x2"	60197931	2 x DN 50	THREADED	AISI 304 STAINLESS STEEL	25				•			
	DN 50x2"	60119215	2 x DN 50	THREADED	STAINLESS STEEL	40				•			
	DN 65x2" ½	60197937	2 x DN 65	THREADED	AISI 304 STAINLESS STEEL	25					•		
	DN 65x2" ½	60163388	2 x DN 65	THREADED	GALVANIZED STEEL	40					•		
	DN 80x3"	60197939	2 x DN 80	THREADED	AISI 304 STAINLESS STEEL	25						•	
	DN 80x3"	60163389	2 x DN 80	THREADED	GALVANIZED STEEL	40						•	
	DN 100x4"	60168815	2 x DN 100	THREADED	GALVANIZED STEEL	25							•

UNIONS	MODEL	CODE	KVCE - KVC	KVCX
	UNIONS MF 1" ¼ (one for DNA and one for DNM)	547820550	•	•

The unions must be ORDERED SEPARATELY. One for Delivery port and one for Suction port

# ACCESSORIES

## CENTRIFUGAL PUMPS

SHIMS KIT	MODEL	CODE	For pump type	P2 kW	DIMENSIONS A x B x H mm	NKM-GE NKM-G 4 POLES	NKP-GE NKP-G 2 POLES
 <p>SHIMS KIT NR 5</p>	SHIMS KIT NR 1	147120800	NKM-G 65-315/309/1¼	11	90 x 335 x 65	•	
	SHIMS KIT NR 5	147120840	NKM-G 80-250/270/1¼	11	80 x 290 x 40	•	
	SHIMS KIT NR 2	147120810	NKM-G 80-315/305/15/4	15	90 x 335 x 90	•	
	SHIMS KIT NR 3	147120820	NKM-G 80-315/320/18,5/4	18,5	100 x 320 x 70	•	
			NKM-G 80-315/334/22/4	22			
	SHIMS KIT NR 1	147120800	NKM-G100-250/250/1¼	11	90 x 335 x 65	•	
			NKM-G100-250/270/15/4	15			
	SHIMS KIT NR 3	147120820	NKM-G100-315/300/18,5/4	18,5	100 x 320 x 70	•	
			NKM-G100-315/316/22/4	22			
	SHIMS KIT NR 2	147120810	NKM-G125-250/243/15/4	15	90 x 335 x 90	•	
	SHIMS KIT NR 3	147120820	NKM-G125-250/256/18,5/4	18,5	100 x 320 x 70	•	
			NKM-G125-250/266/22/4	22			
	SHIMS KIT NR 4	147120830	NKM-G150-200/218/1¼	11	80 X 290 X 120	•	
	SHIMS KIT NR 6	147120850	NKP-G 32-125/142/ 3/2	3	50 x 100 x 20	•	
			NKP-G 32-160/177/5,5/2	5,5			
			NKP-G 40-125/130/ 3/2	3			
			NKP-G 40-125/139/ 4/2	4			
			NKP-G 40-160/158/ 5,5/2	5,5			
NKP-G 40-160/172/ 7,5/2			7,5				
SHIMS KIT NR 7	147120860	NKP-G 40-200/210/1½	11	70 X 332 X 20	•		
		NKP-G 40-250/230/15/2	15				
		NKP-G 40-250/245/18,5/2	18,5				
SHIMS KIT NR 6	147120850	NKP-G 50-125/135/ 5,5/2	5,5	50 X 100 X 20	•		
		NKP-G 50-125/144/ 7,5/2	7,5				
SHIMS KIT NR 7	147120860	NKP-G 50-160/169/1½	11	70 X 332 X 20	•		
		NKP-G 50-200/200/15/2	15				
		NKP-G 50-200/210/18,5/2	18,5				
		NKP-G 65-160/157/1½	11				
		NKP-G 65-160/173/15/2	15				
		NKP-G 65-200/190/18,5/2	18,5				
		NKP-G 80-160/147-127/1½	11				
		NKP-G 80-160/153/15/2	15				
NKP-G 80-160/163/18,5/2	18,5						
SHIMS KIT NR 8	147120870	NKP-G 80-200/190/30/2	30	70 X 125 X 20	•		

Available on request separately from the pump. Used to level the pump during installation so as to make up for the difference in centreline heights between the pump and the motor. The kit comprises two shims with dimensions A (width), B (length), H (height) shown in the table. The shims with a height of over 20 mm are supplied complete with screws, nuts and washers in order to fix them to the pump and motor.



**NEW RANGE**  
**SUBMERSIBLE PUMPS**



DRAINAGE



EFFLUENT



SEWAGE



**WHEN THE GOING GETS TOUGH...**

[FX.DABPUMPS.COM](http://FX.DABPUMPS.COM)





**NOVA** NEW  
SUBMERSIBLE PUMPS FOR DRAINAGE  
A7 PAG. 212



**FEKA FXV** NEW  
SUBMERSIBLE PUMPS FOR SEWAGE  
FS PAG. 220



**FEKAFOS 280 DOUBLE**  
AUTOMATIC PUMPING STATION  
CK PAG. 233



**NOVA UP**  
SUBMERSIBLE PUMPS  
A7 PAG. 213



**FEKA FXC** NEW  
SUBMERSIBLE PUMPS FOR EFFLUENT  
FS PAG. 222



**FEKAFOS 550 DOUBLE**  
AUTOMATIC PUMPING STATION  
CK PAG. 234



**NOVA UP MAE**  
SUBMERSIBLE PUMPS  
A7 PAG. 213



**FK**  
SUBMERSIBLE PUMPS  
EM PAG. 225



**FEKAFOS MAXI  
1200/3600**  
FK PUMP AUTOMATIC LIFTING STATION  
CK PAG. 235



**VERTY NOVA**  
INTEGRATED FLOAT SWITCH  
SUBMERSIBLE PUMPS  
A7 PAG. 214



**FEKA 6200/6300/8100/  
8200/8300**  
SEWAGE PUMPS  
CE CF PAG. 228



**NOVAIR**  
SUBMERGED AERATOR  
AK PAG. 241



**FEKA** NEW  
SUBMERSIBLE PUMPS FOR EFFLUENT  
CG PAG. 215



**GENIX**  
AUTOMATIC LIFTING STATIONS  
DC PAG. 229



**ACCESSORIES**  
PAG. 243



**FEKA BVP**  
SEWAGE PUMPS  
AF PAG. 216



**GENIX VT**  
AUTOMATIC LIFTING STATIONS  
DC PAG. 230



**EBOX**  
ELECTRONIC PROTECTION  
AND CONTROL PANEL  
AT PAG. 249



**DRENAG 1000 - 1200**  
SUBMERSIBLE PUMPS  
C8 PAG. 216



**NOVABOX**  
SMALL LIFTING STATIONS FOR AUTOMATIC  
COLLECTING AND PUMPING SEWAGE  
AE PAG. 231



**PANELS**  
PAG. 254



**FEKA VS**  
SEWAGE PUMPS  
CJ PAG. 217



**FEKABOX 110**  
AUTOMATIC PUMPING STATION  
CK PAG. 231



**DRENAG FX** NEW  
SUBMERSIBLE PUMPS FOR DRAINAGE  
OF SANDY WATER AND WATER FROM  
CONSTRUCTION SITE  
FS PAG. 218



**FEKABOX 200** NEW MODEL  
AUTOMATIC PUMPING  
STATION  
CK PAG. 232



**GRINDER FX** NEW  
SUBMERSIBLE PUMPS WITH  
CUTTING SYSTEM FOR SEWAGE  
FS PAG. 219



**FEKAFOS 280**  
AUTOMATIC PUMPING STATION  
CK PAG. 233

# NOVA

## SUBMERSIBLE PUMPS FOR DRAINAGE

**NEW**

NOVA M-A



NOVA M-NA

Submersible pump for drainage also rainwater in residential building service. The Nova series has been redesigned to mark forty years of commercialization, making it even more reliable, resistant and ergonomic. It can also be used for emptying tanks or cisterns. It is suitable for fixed or portable installations and it is available in the automatic version with the integrated float switch or in the manual version without the float. The pump is suitable for draining flooded basements, cellars and garages or to prevent flooding when installed in rainwater collection wells, and can be used as a portable pump in emergency situations to drain water from flooded premises. A 90° fitting is provided for vertical delivery. The pump body, the impeller and the suction grid are in technopolymer, the motor shaft in stainless steel. Thermal protection incorporated in all single-phase versions. It can work in dry run for up to 1 minute. 10 mm free passage.

In compliance with the European standard EN 60335-2-41 in case of external use the 10 meter power cable is mandatory.

**Flow rate minimum and maximum**

 from 1 m<sup>3</sup>/h to 16 m<sup>3</sup>/h

**Head up to** 10,2 m

**Type of pumped liquid** Drainage water, mostly celan, rainwater

**Free passage**

5 mm or 10 mm depending on the model

**Supported liquid temperature (maximum and minimum)**

From +0°C to +35°C for domestic use

From +0°C to +50° C other use

**Outlet connection** Threated 1" 1/4

**Impeller material** Technopolymer

**Class of protection** IP 68

**Motor insulation class** F

**Dry run time** 1 minute

**Possible type of installation**

Fixed or portable in vertical position



YEARS ANNIVERSARY

 1979-2019  
**NOVA FEKA**

Celebration

 REPLACEMENT TABLE  
 PAG. 224

 PANELS  
 PAG. 254

 ACCESSORIES  
 PAG. 243

MODEL	CODE	ELECTRICAL DATA					HYDRAULIC DATA					DNM GAS	CABLE*	WEIGHT KG	Q.TY x PALLET	
		VOLTAGE 50 Hz	P1 MAX kW	P2 NOMINAL		In A	Q=m <sup>3</sup> /h	0	3	6	9					12
				kW	HP											
NOVA 180 M A 40th	60195073	1X230 V~	0,19	0,2	0,27	0,9	H (m)	5	3,2			1" ¼	5m H05	4,6	48	
NOVA 180 M A 40th	60198013	1X230 V~	0,19	0,2	0,27	0,9		5	3,2			1" ¼	10m H05	4,6	48	
NOVA 180 M NA 40th	60195632	1X230 V~	0,19	0,2	0,27	0,9		5	3,2			1" ¼	10m H05	4,6	48	
NOVA 200 M NA 40th	60194402	1X230 V~	0,35	0,22	0,30	1,5		7,1	5,6	4,2	2,8	1,5	1" ¼	10m H05	4,6	48
NOVA 300 M A 40th	60194400	1X230 V~	0,35	0,22	0,29	1,5		7,2	5,8	4,6	3,4	2,2	1" ¼	5m H05	4,6	48
NOVA 300 M A 40th	60198014	1X230 V~	0,35	0,22	0,29	1,5		7,2	5,8	4,6	3,4	2,2	1" ¼	10m H05	4,6	48
NOVA 600 M A 40th	60191566	1X230 V~	0,66	0,5	0,67	3,0		10,4	9	7,8	6,7	5,3	1" ¼	5m H05	7	32
NOVA 600 M A 40th	60198015	1X230 V~	0,66	0,5	0,67	3,0		10,4	9	7,8	6,7	5,3	1" ¼	10m H05	7	32
NOVA 600 M NA 40th	60195636	1X230 V~	0,66	0,5	0,67	3,0		10,4	9	7,8	6,7	5,3	1" ¼	10m H05	7	32
NOVA 600 T NA 40th	60196306	3X400 V~	0,66	0,5	0,67	1,7		10,4	9	7,8	6,7	5,3	1" ¼	10m H07	7	32

**A=** automatic with float

**NA=** non automatic without float

\*As per European standard EN 60335-2-41, for outdoor use power cable must be 10m long.

# NOVA UP

## SUBMERSIBLE PUMPS



NOVA UP M-A



NOVA UP M-NA

Vertical flow drainage pump in an automatic or manual version with removable filter for suction up to 2/3 mm, features that make it a strong pump and allow for installation versatility.

These pumps can be used with liquids that contain solids of a maximum size up to 10 mm.

Pump body, impeller, Cap and grille in technopolymer.

The motor, rotor shaft and screws in stainless steel.

Triple O-ring seal with interposed oil Chamber.

Asynchronous submersible motor for continuous operation. Stator in a sealed stainless steel enclosure.

Rotor mounted on ball bearings greased for life and oversized.

Thermal-ampere protection incorporated and condenser permanently connected.

### Operating range

from 1 to 15 m<sup>3</sup>/h with prevalence up to 10 meters.

### Temperature range of the liquid

from 0 °C to +35 °C for domestic use.

### Pumped liquid temperature

murky waters without fibers

### Minimum depth of draft

NOVA UP-300M - 120 mm

NOVA UP 300M - 60 mm

NOVA UP 600M - 165 mm

NOVA UP 600M - 70 mm

### Maximum immersion depth

7 meters.

### Installation

vertical, fixed or portable.

### Degree of protection

IP 68.

### Insulation class

F

# NOVA UP

MODEL	CODE	ELECTRICAL DATA				HYDRAULIC DATA													DNM GAS	CABLE	WEIGHT KG	Q.TY x PALLET										
		VOLTAGE 50 Hz	P1 MAX kW	P2 NOMINAL		In A	Q=m <sup>3</sup> /h	0	1	2	3	4,5	5	6	7	7,5	9	10					12	13,5	Q=l/min	0	16,6	33,3	50	75	83,3	100
NOVA UP 300 M-A	60152305	1X220-240 V~	0,38	0,21	0,28	1,5	H (m)	7,6	6,9	6,25	5,6	4,7	4,4	3,6	2,8	2,3	1				1" ¼	10 mt.	5,8	39								
NOVA UP 300 M-NA	60152309	1X220-240 V~	0,38	0,21	0,28	1,5		7,6	6,9	6,25	5,6	4,7	4,4	3,6	2,8	2,3	1				1" ¼	10 mt.	5,6	39								
NOVA UP 600 M-A	60152306	1X220-240 V~	0,77	0,52	0,69	3,5		9,8	9,4	9	8,5	7,7	7,4	6,8	6,2	5,9	4,7	3,9	2	0,3	1" ¼	10 mt.	7,3	26								
NOVA UP 600 M-NA	60152310	1X220-240 V~	0,77	0,52	0,69	3,5		9,8	9,4	9	8,5	7,7	7,4	6,8	6,2	5,9	4,7	3,9	2	0,3	1" ¼	10 mt.	7,1	26								

A= automatic with float NA= non automatic without float

# NOVA UP MAE

## SUBMERSIBLE PUMPS



NOVA UP MAE



NOVA UP MAE

Electronic pump drainage with vertical adjustable (automatic or manual) with removable filter for suction up to 2/3 mm. The adjustment slider of the probes, allows you to vary the level of on-off of the pump, this feature increases the versatility of installation.

The vertical delivery and the electronic float make it a pump suitable for use in wells of small dimensions.

These pumps can be used with liquids containing solids up to 10 mm maximum size.

Pump body, impeller, cap and grille in technopolymer.

The motor, rotor shaft and screws in stainless steel.

Triple O-ring seal with interposed oil chamber.

Asynchronous submersible motor for continuous operation. Stator in a sealed stainless steel enclosure.

Rotor mounted on ball bearings greased for life and oversized.

Thermal-ampere protection incorporated and condenser permanently connected.

### Operating range

from 1 to 15 m<sup>3</sup>/h-with prevalence up to 10 meters.

### Temperature range of the liquid

from 0° C to +35° C for domestic use.

### Pumped liquid temperature

murky waters without fibers

### Minimum depth of draft

NOVA UP 300 M-AE 60 mm

NOVA UP 600 M-AE 70 mm

### Maximum immersion

7 meters.

### Installation

vertical, portable or fixed.

### Degree of protection

IP 68.

### Insulation class

F.

MODEL	CODE	ELECTRICAL DATA				HYDRAULIC DATA													DNM GAS	CABLE	WEIGHT KG	Q.TY x PALLET										
		VOLTAGE 50 Hz	P1 MAX kW	P2 NOMINAL		In A	Q=m <sup>3</sup> /h	0	1	2	3	4,5	5	6	7	7,5	9	10					12	13,5	Q=l/min	0	16,6	33,3	50	75	83,3	100
NOVA UP 300 M-AE	60153572	1X220-240 V~	0,38	0,21	0,28	1,5	H (m)	7,6	6,9	6,25	5,6	4,7	4,4	3,6	2,8	2,3	1				1" ¼	10 mt.	5,6	39								
NOVA UP 600 M-AE	60153573	1X220-240 V~	0,77	0,52	0,69	3,5		9,8	9,4	9	8,5	7,7	7,4	6,8	6,2	5,9	4,7	3,9	2	0,3	1" ¼	10 mt.	7,3	26								

A= automatic with float E= Electronic

# VERTY NOVA

## INTEGRATED FLOAT SWITCH SUBMERSIBLE PUMPS



Submersible pumps specifically designed for uses in narrow pits with dimensions down to 20 cm x 20 cm. Suitable to pump clear water containing particles with maximum diameter up to 5 mm.

### Pump with built-in float switch

Anti-corrosive and rust-proof materials.

Integrated float switch.

Low suction capability: 2 – 3 mm (manual mode).

Very low priming and starting level of the pump: 10 – 15 mm (manual mode).

Knob for manual or automatic operation.

Easy access through sliding cover to float switch for cleaning.

Motor with thermal overload protection.

Excellent cooling of the motor that enables the pump to operate even when it is partially submersible.

Supplied with power cable with plug, non return valve and 4-step fitting.

### Operating range

from 1 to 10m<sup>3</sup>/h with head up to 9 metres.

### Liquid temperature range

from 0 °C to +35 °C for domestic use.

**Pumped liquid** dirty water without fibres.

### Pump priming limit

10-15 mm in manual operation.

**Max. immersion depth** 7 metres.

MODEL	CODE	ELECTRICAL DATA					HYDRAULIC DATA													DNM GAS	CABLE	WEIGHT KG	Q.TY x PALLET
		VOLTAGE 50 Hz	P1 MAX kW	P2 NOMINAL		In A	Q=m <sup>3</sup> /h	0	1	2	3	4,5	5	6	7	7,5	9	10					
				kW	HP														Q=l/min				
VERTY NOVA 200 M	60122636	1X230 V~	0,3	0,2	0,28	1,3	H (m)	6,9	6,5	6	5,8	4,5	4	3	1,8			1"¼	10 mt.	4,2	40		
VERTY NOVA 400 M	60122637	1X230 V~	0,6	0,4	0,55	2,6	H (m)	9	8,8	8,5	8,1	7,8	7	6,7	6	5,7	4,2	3,5	1"¼	10 mt.	5,1	40	



# FEKA

SUBMERSIBLE PUMPS FOR EFFLUENT



**NEW**



FEKA M-A



FEKAM-NA



YEARS ANNIVERSARY Celebration

Submersible pumps suitable for draining and lifting effluent wastewater and rainwater in residential building service.

The pumps have been redesigned on the occasion of the forty years of marketing, making them even more reliable, resistant and ergonomic.

The impeller in technopolymer allows the passage of solid bodies up to 25 mm. The pumps are designed for fixed or mobile installations and are available in automatic versions with integrated float switch or in manual version without float.

The pump body and the intake grid are in technopolymer, the motor shaft in AISI 431 motor shaft suitable for light salty water. Robust and reliable, they have a triple ring seal in oil bath and an asynchronous submersible motor with continuous service. Stator inserted in an airtight stainless steel casing and rotor mounted on oversized ball bearings to increase its durability. Thermal protection incorporated in all single-phase versions. The pumps can run dry for up to 1 minute. New sealed cable gland design and new motors, more compact and efficient. Impeller bolt sealing to prevent corrosion at bolt motor shaft.

In compliance with European standard EN 60335-2-41, the 10-meter power cable is mandatory for the pump in external use.

### Flow rate minimum and maximum

Da 1 m<sup>3</sup>/h a 16 m<sup>3</sup>/h

Head up to 7,5 m

Type of pumped liquid wastewater and rainwater

Free passage 25 mm

Supported liquid temperature (maximum and minimum)

From 0°C to +35°C for domestic use

Class of protection IP 68

Motor insulation class F

Possible type of installation

Fixed or portable in vertical position

REPLACEMENT TABLE PAG. 224

PANELS PAG. 254

ACCESSORIES PAG. 243

## FEKA 300

**NEW MODELS**

MODEL	CODE	ELECTRICAL DATA				HYDRAULIC DATA					DNM GAS	CABLE*	WEIGHT KG	Q.TY x PALLET		
		VOLTAGE 50 Hz	P1 MAX kW	P2 NOMINAL		In A	Q=m <sup>3</sup> /h	0	3	6					9	12
				kW	HP		Q=l/min	0	50	100					150	200
FEKA 300 M A 40th	60191897	1X230 V~	0,35	0,22	0,30	1,9	H (m)	6,4	5,5	4,4	3,1	1,6	1" ¼	5m H05	4,6	48
FEKA 300 M A 40th	60198016	1X230 V~	0,35	0,22	0,30	1,9		6,4	5,5	4,4	3,1	1,6	1" ¼	10m H05	4,6	48
FEKA 300 M NA 40th	60195558	1X230 V~	0,35	0,22	0,30	1,9		6,4	5,5	4,4	3,1	1,6	1" ¼	10m H05	4,6	48

A: automatic with float

NA: non automatic without float

\* As per European standard EN 60335-2-41, for outdoor use power cable must be 10m long.

## FEKA 600

MODEL	CODE	ELECTRICAL DATA				HYDRAULIC DATA						DNM GAS	CABLE*	WEIGHT KG	Q.TY x PALLET		
		VOLTAGE 50 Hz	P1 MAX kW	P2 NOMINAL		In A	Q=m <sup>3</sup> /h	0	3	6	9					12	15
				kW	HP		Q=l/min	0	50	100	150					200	250
FEKA 600 M A 40th	60190343	1X230 V~	0,68	0,5	0,67	3,1	H (m)	8,9	8,2	7,2	6,1	4,7	2,9	1" ¼	5m H05	7	32
FEKA 600 M A 40th	60198017	1X230 V~	0,68	0,5	0,67	3,1		8,9	8,2	7,2	6,1	4,7	2,9	1" ¼	10m H05	7	32
FEKA 600 M NA 40th	60194419	1X230 V~	0,68	0,5	0,67	3,1		8,9	8,2	7,2	6,1	4,7	2,9	1" ¼	10m H05	7	32
FEKA 600 T NA 40th	60196308	3X400 V~	0,68	0,5	0,67	1,8		8,9	8,2	7,2	6,1	4,7	2,9	1" ¼	10m H07	7	32

A: automatic with float

NA: non automatic without float

\* As per European standard EN 60335-2-41, for outdoor use power cable must be 10m long.

# FEKA BVP

SEWAGE PUMPS



**Powerful** submersible pumps for **drainage and emptying duty**. Designed for pumping foul water containing solid particles of no more than 38 mm in diameter.  
Anti-corrosion and anti-oxidation materials.  
Motor with THERMAL PROTECTION against overheating.  
Wear-resistant motor shaft and impeller.  
Excellent motor cooling to allow pump to run even when only partially submerged.  
Automatic version equipped with float switch for automatic starting and stopping of the pump, and Manual version.  
Equipped with power cable with plug, and 3-level union, without check valve.

**Operating range**  
from 1 to 18 m<sup>3</sup>/h with head up to 12 metres.  
**Liquid temperature range**  
from 0 °C to +35 °C.  
**Pumped liquid**  
dirty water with maximum solid particle size 38 mm.  
**Max. immersion depth** 7 metres.

MODEL	CODE	ELECTRICAL DATA				HYDRAULIC DATA																		DNM GAS	CABLE	WEIGHT KG	Q.TY x PALLET
		VOLTAGE 50 Hz	P1 MAX kW	P2 NOMINAL kW	HP	In A	Q=m <sup>3</sup> /h	0	1	2	3	4,5	5	6	7	7,5	9	10	12	15	18						
FEKA BVP 700 M-A	60122690	1x230 V~	1,0	0,70	0,95	4,6	H (m)	10,5	10	9,9	9,5	8,9	8,8	8,1	7,8	7,5	7	6,1	5,1	4	1,5	1 1/2	10 mt.	8	27		
FEKA BVP 750 M-A	60122691	1x230 V~	1,1	0,75	1	5,6		12	11,7	11,1	11	10,4	10,1	9,8	9,1	9	8,8	8	7	6	3,6	1 1/2	10 mt.	8	27		

COMMAND AND CONTROL SYSTEMS

CIRCULATORS AND IN-LINE PUMPS

MULTISTAGE CENTRIFUGAL AND SELF-PRIMING PUMPS

SWIMMING POOL, POND AND SALT WATER PUMPS

CENTRIFUGAL PUMPS

SUBMERSIBLE PUMPS

SUBMERSIBLE PUMPS AND SUBMERSIBLE MOTORS

PRESSURE UNITS

# DRENAG 1000 - 1200

SUBMERSIBLE PUMPS



Submersible electric pump in AISI 304 Stainless Steel: pump body, impeller, motor flange, filter and filter cover, motor casing, outer casing with handle, cable compartment cover.  
Shaft in AISI 316 stainless steel.  
Handle coated with insulating rubber. **Double mechanical seal** with oil chamber interposed, carbon/alumina on motor side and silicon/silicon carbide on pump side. **Dry motor**, asynchronous, watertight, cooled by the pumped liquid itself. Standard thermal protection in the winding. Capacitor permanently on in the single-phase version. 10 metres of H07RN-F power cables with schuko plug are supplied as a standard USA plug instead could be also available on request. All models can be supplied either with or without float.

**Operating range**  
from 3 to 24 m<sup>3</sup>/h with head up to 14.2 mt.  
**Liquid temperature range**  
from 0°C to +35°C for domestic use, from 0°C to +50°C.  
**Pumped liquid characteristics**  
rain water, phreatic water, sandy water from building yards and clean waste waters, not aggressive.  
**Maximum working temperature**  
+40°C with the motor out of the water.  
**Free passage through the suction grid** 10 mm.  
**Maximum immersion depth** 7 mt.  
**Protection level** IP 68.  
**Insulation class** F.  
**Installation** fixed or portable, in a vertical position.

PANELS  
PAG. 254

ACCESSORIES  
PAG. 243

MODEL	CODE	ELECTRICAL DATA				HYDRAULIC DATA												DNM GAS	FREE PASSAGE mm	WEIGHT KG	Q.TY x PALLET
		VOLTAGE 50 Hz	P1 MAX kW	P2 NOMINAL kW	HP	In A	Q=m <sup>3</sup> /h	0	3	6	9	12	15	18	24						
DRENAG 1000 M-A	103041000	1x230 V~	1,29	1	1,36	6	H (m)	15,3	13,7	12,1	10,5	8,7	6,8	4,7		1 1/2	10	17	24		
DRENAG 1000 M-NA	103041010	1x230 V~	1,29	1	1,36	6		15,3	13,7	12,1	10,5	8,7	6,8	4,7		1 1/2	10	17	24		
DRENAG 1000 T-NA	103041020	3x400 V~	1,18	1	1,36	2,43		15,3	13,7	12,1	10,5	8,7	6,8	4,7		1 1/2	10	17	24		
DRENAG 1200 M-A	103041040	1x230 V~	1,85	1,2	1,6	7,5		17	15,4	13,8	12,4	10,7	9	7,3	3,3	1 1/2	10	18,5	24		
DRENAG 1200 M-NA	103041050	1x230 V~	1,85	1,2	1,6	7,5		17	15,4	13,8	12,4	10,7	9	7,3	3,3	1 1/2	10	18,5	24		
DRENAG 1200 T-NA	103041060	3x400 V~	1,65	1,2	1,6	3,24		17	15,4	13,8	12,4	10,7	9	7,3	3,3	1 1/2	10	18,5	24		

**A:** automatic with float  
**NA:** non automatic without float  
**T:** three-phase

# FEKA VS

## SEWAGE PUMPS



Submersible centrifugal pump with liquid vortex cast steel impeller, suitable for pumping sewer water and waste water in general containing solids up to a maximum size of 50 mm. Handle with insulating rubber cover. AISI 316 stainless steel drive shaft. Double mechanical seal with intermediate oil chamber (atoxic oil), in carbon/alumina on the motor side and silicon carbide/silicon carbide on the pump side. Dry, asynchronous, sealed and cooled by the pumped liquid. Rotor mounted on greased for-life ball bearings, oversized and selected to guarantee greater noise reduction and duration. Thermo-amperometersc protection as standard for single-phase version, and the user's responsibility for the three-phase version. Constantly active capacitor on the single-phase version. Construction in accordance with the IEC 2-3 IEC 61-69 (EN 60335-2-41) standards.

**Motor protection class** IP 68

**Insulation class** F

**Standard voltage**

220-240V 50Hz Single-phase

400V 50Hz Three-phase

Continual running with liquid at 35 °C and pump completely submersible. The single-phase version can be supplied with float for automatic function.

**Power supply cable** 10 mt of H07RN-F cable with Shuko plug for the single-phase version and 10 meters of H07RN-F cable for the three-phase version.

**Operating range**

from 0 to 32 m<sup>3</sup>/h with head up to 14 mt

**Pumped liquid** sewer water and waste water in general and non aggressive.

**Liquid temperature range** from 0°C to +35°C for household use (EN 60335-2-41), from 0°C to +50°C for other uses.

**Maximum ambient temperature for pump running with submersible motor** +40°C

**Maximum immersion depth** 10 mt

**Installation** fixed or portable, vertical.

**Free Passage** 50 mm

PANELS  
PAG. 254

ACCESSORIES  
PAG. 243

# FEKA VS

MODEL	CODE	ELECTRICAL DATA					HYDRAULIC DATA														DNM GAS	FREE PASSAGE mm	CABLE*	WEIGHT KG	Q.TY x PALLET
		VOLTAGE 50 Hz	P1 MAX kW	P2 NOMINAL kW HP		In A	Q=m <sup>3</sup> /h	0	3	6	9	12	15	18	24	30	Q=l/min	0	50	100					
FEKA VS 550 M-A	103040000	1X220 - 240 V~	0,92	0,55	0,75	4,2	H (m)	7,4	6,9	6,2	5,6	4,1	3,2	1,8			2"	50	10m H07	16,3	24				
FEKA VS 550 M-NA	103040010	1X220 - 240 V~	0,92	0,55	0,75	4,2		7,4	6,9	6,2	5,6	4,1	3,2	1,8			2"	50	10m H07	16,3	24				
FEKA VS 550 T-NA	103040020	3X400 V~	0,90	0,55	0,75	1,64		7,4	6,9	6,2	5,6	4,1	3,2	1,8			2"	50	10m H07	16,3	24				
FEKA VS 750 M-A	103040040	1X220 - 240 V~	1,11	0,75	1	5,13		9,6	9,2	8,5	7,6	6,7	5,6	4,3	1,9		2"	50	10m H07	17,5	24				
FEKA VS 750 M-NA	103040050	1X220 - 240 V~	1,11	0,75	1	5,13		9,6	9,2	8,5	7,6	6,7	5,6	4,3	1,9		2"	50	10m H07	17,5	24				
FEKA VS 750 T-NA	103040060	3X400 V~	1,02	0,75	1	1,94		9,6	9,2	8,5	7,6	6,7	5,6	4,3	1,9		2"	50	10m H07	17,5	24				
FEKA VS 1000 M-A	103040080	1X220 - 240 V~	1,46	1	1,36	6,63		11,8	11,3	10,5	9,8	9,0	8,0	6,8	4,1		2"	50	10m H07	19,3	24				
FEKA VS 1000 M-NA	103040090	1X220 - 240 V~	1,46	1	1,36	6,63		11,8	11,3	10,5	9,8	9,0	8,0	6,8	4,1		2"	50	10m H07	19,3	24				
FEKA VS 1000 T-NA	103040100	3X400 V~	1,37	1	1,36	2,51		11,8	11,3	10,5	9,8	9,0	8,0	6,8	4,1		2"	50	10m H07	19,3	24				
FEKA VS 1200 M-A	103040120	1X220 - 240 V~	1,93	1,2	1,6	8,63		14	13,4	12,8	12,0	11,2	10,1	9,0	6,7	4	2"	50	10m H07	20,8	24				
FEKA VS 1200 M-NA	103040130	1X220 - 240 V~	1,93	1,2	1,6	8,63		14	13,4	12,8	12,0	11,2	10,1	9,0	6,7	4	2"	50	10m H07	20,8	24				
FEKA VS 1200 T-NA	103040140	3X400 V~	1,86	1,2	1,6	3,44		14	13,4	12,8	12,0	11,2	10,1	9,0	6,7	4	2"	50	10m H07	20,8	24				

# DRENAG FX

SUBMERSIBLE PUMPS FOR DRAINAGE OF SANDY WATER AND WATER FROM CONSTRUCTION SITE



**NEW**



Submersible pump for the draining clear water, groundwater or rainwater in commercial building service; the pumps is suitable for applications requiring with high head.

The pump is certified according to EN 12050-2 waste water regulation. Suitable for fixed installations with coupling device or mobile if placed directly on the bottom of the tank. The reduced dimensions and the outlet connection both flanged and threaded make it ideal for replacements. Designed for fast maintenance thanks to a construction solution that provides easy access to the main components of the pump. Open impeller and anti-wear rubber disc for use even in the presence of abrasive particles. Double mechanical seal in silicon carbide completely protected in an oil chamber and not in contact with the pumped liquid. Motor shaft in stainless steel AISI 431 for P2 <1,2 kW and AISI 304 for P2 > 1,5 kW, resin cable gland with quick coupling. Single-phase versions with integrated capacitor, available with float for automatic operation (MA) with powers up to 1,5 kW. In the three-phase versions the protection is the responsibility of the user.

ATEX version available for use in potentially explosive environments (ATES certifications: II2G Ex db IIB T4 GB o IEC EX: Ex db IIB T4 Gb).

**Flow rate maximum** 30,9 m<sup>3</sup>/h

**Head up to** 32 m

**Type of pumped liquid** clear water, rainwater and sandy water from construction site

**Free passage** 10 mm

**Supported liquid temperature (max)**  
+50°C (+60°C for a short period of time)  
+40°C for ATEX version

**Flanged and threaded** 1" 1/2, DN 32, DN 40

**Impeller type** Open

**Class of protection** IP 68

**Motor insulation class** F

**Dry run time** 10 min

**Possible type of installation**

Mobile if on the floor, fixed on the coupling

**Special versions on request**

Different cable length, different voltage

## DRENAG FX

REPLACEMENT  
TABLE  
PAG. 224

PANELS  
PAG. 254

ACCESSORIES  
PAG. 243

MODEL	CODE	ELECTRICAL DATA					HYDRAULIC DATA														DNM		FREE PASSAGE mm	WEIGHT KG	Q.TY x PALLET
		VOLTAGE 50 Hz	P1 MAX kW	P2 NOMINAL		In A	Q=m <sup>3</sup> /h														GAS	DN1			
				kW	HP		0	3	6	9	12	15	18	21	24	27	30	30	35	40					
DRENAG FX 15.07 MA	60191219	1x230V	1,1	0,8	1,1	5,1	H (m)														Rp 1"1/2	DN32 PN10 / 6 DN40 PN6	10	35	6
DRENAG FX 15.07 MNA	60191217	1x230V	1,1	0,8	1,1	5,1	H (m)														Rp 1"1/2	DN32 PN10 / 6 DN40 PN6	10	35	6
DRENAG FX 15.07 TNA	60191218	3x400V	1	0,8	1,1	2,1	H (m)														Rp 1"1/2	DN32 PN10 / 6 DN40 PN6	10	35	6
DRENAG FX 15.11MA	60191239	1x230V	1,5	1,2	1,6	6,8	H (m)														Rp 1"1/2	DN32 PN10 / 6 DN40 PN6	10	35	6
DRENAG FX 15.11 MNA	60191237	1x230V	1,5	1,2	1,6	6,8	H (m)														Rp 1"1/2	DN32 PN10 / 6 DN40 PN6	10	35	6
DRENAG FX 15.11 TNA	60191238	3x400V	1,5	1,2	1,6	2,8	H (m)														Rp 1"1/2	DN32 PN10 / 6 DN40 PN6	10	35	6
DRENAG FX 15.15 MA	60191257	1x230V	2,3	1,8	2,4	10,6	H (m)														Rp 1"1/2	DN32 PN10 / 6 DN40 PN6	10	38	6
DRENAG FX 15.15 MNA	60191255	1x230V	2,3	1,8	2,4	10,6	H (m)														Rp 1"1/2	DN32 PN10 / 6 DN40 PN6	10	38	6
DRENAG FX 15.15 TNA	60191256	3x400V	2,5	1,8	2,4	4,3	H (m)														Rp 1"1/2	DN32 PN10 / 6 DN40 PN6	10	38	6
DRENAG FX 15.22 TNA	60191277	3x400V	3,1	2,3	3,1	5,2	H (m)														Rp 1"1/2	DN32 PN10 / 6 DN40 PN6	10	39	6

In case of not availability please look at the replacement table at pag.224 for the correspondent old models.

## ATEX VERSION

MODEL	CODE
DRENAG FX 15.07 MNA 220-240/50 EX	60194109
DRENAG FX 15.07 TNA 400/50 EX	60194110
DRENAG FX 15.11 MNA 220-240/50 EX	60194160
DRENAG FX 15.11 TNA 400/50 EX	60194161
DRENAG FX 15.15 MNA 220-240/50 EX	60194218
DRENAG FX 15.15 TNA 400/50 EX	60194219
DRENAG FX 15.22 TNA 400/50 EX	60194280

discover **FX** complete range  
[fx.dabpumps.com](http://fx.dabpumps.com)



# GRINDER FX

SUBMERSIBLE PUMPS WITH CUTTING SYSTEM FOR SEWAGE

**NEW**



## GRINDER FX

Submersible pump with shredder designed for lifting and transferring sewage water in commercial building service.

Grinder FX is certified for the European Union standard EN 12050-1 which applies to sewage lifting plants containing faecal material in buildings and construction sites.

Suitable for fixed installations with a coupling or mobile if the pumps is placed directly on the bottom of the tank. Thanks to the shredder, the pump is suitable for installations with small diameter pipes or installation that require high pressures. High strength shredding system in AISI 630 steel. Double mechanical seal in silicon carbide completely protected in oil bath and not in contact with the pumped liquid. Motor shaft in AISI 304 stainless steel, resin-fastened cable gland. The reduced overall dimensions and the outlet ports both flanged and threaded make it ideal for replacements. Maintenance is fast due to its design that allows easy access to the pump's main components. Single-phase versions with integrated capacitor, available with float for automatic operation (MA) with powers up to 1,5 kW. In the three-phase versions the protection is the user's responsibility.

ATEX version available for use in potentially explosive environments. (ATES certifications: II2G Ex db IIB T4 GB o IEC EX: Ex db IIB T4 Gb).

**Flow rate maximum** 19,8 m<sup>3</sup>/h

**Head up to** 33 m

**Type of pumped liquid** Loaded waters with filamentary bodies, paper or textile material

**Supported liquid temperature (max)**  
+50°C (+60°C for a short period of time)  
+40°C for ATEX version

**Flanged and threaded**  
From 1"1/2, DN 32, DN 40

**Impeller type** Grinder

**Class of protection** IP 68

**Motor insulation class** F

**Dry run time** 10 min

**Possible type of installation**

Mobile on the ground or fixed on a coupling device

**Special versions on request** Different cable lengths, different voltages and frequencies

REPLACEMENT  
TABLE  
PAG. 224

PANELS  
PAG. 254

ACCESSORIES  
PAG. 243

MODEL	CODE	ELECTRICAL DATA					HYDRAULIC DATA													DNM		WEIGHT KG	Q.TY x PALLET
		VOLTAGE 50 Hz	P1 MAX kW	P2 NOMINAL		In A	Q=m <sup>3</sup> /h	0	2,4	4,8	7,2	9,6	12	14,4	16,8	19,2	GAS	DN1					
GRINDER FX 15.07 MA	60191222	1x230V	1,1	0,8	1,1	5,3	H (m)	16,9	15,2	13,4	11,4	9,2	6,7	3,9				Rp 1"1/2	DN32 PN10 / 6 DN40 PNG	35	6		
GRINDER FX 15.07 MNA	60191220	1x230V	1,1	0,8	1,1	5,3		16,9	15,2	13,4	11,4	9,2	6,7	3,9				Rp 1"1/2	DN32 PN10 / 6 DN40 PNG	35	6		
GRINDER FX 15.07 TNA	60191221	3x400V	1	0,8	1,1	2		16,9	15,2	13,4	11,4	9,2	6,7	3,9				Rp 1"1/2	DN32 PN10 / 6 DN40 PNG	35	6		
GRINDER FX 15.11 MA	60191242	1x230V	1,5	1,1	1,5	6,8		24,9	22,6	20,5	18,3	15,9	13,2	10,1	6,3	1,8		Rp 1"1/2	DN32 PN10 / 6 DN40 PNG	35	6		
GRINDER FX 15.11 MNA	60191240	1x230V	1,5	1,1	1,5	6,8		24,9	22,6	20,5	18,3	15,9	13,2	10,1	6,3	1,8		Rp 1"1/2	DN32 PN10 / 6 DN40 PNG	35	6		
GRINDER FX 15.11 TNA	60191278	3x400V	1,5	1,1	1,5	2,8		24,9	22,6	20,5	18,3	15,9	13,2	10,1	6,3	1,8		Rp 1"1/2	DN32 PN10 / 6 DN40 PNG	35	6		
GRINDER FX 15.15 MA	60191260	1x230V	2,2	1,6	2,1	9,8		27,3	25,2	23,3	21,4	19,5	17,3	14,8	11,9	8,5		Rp 1"1/2	DN32 PN10 / 6 DN40 PNG	38	6		
GRINDER FX 15.15 MNA	60191258	1x230V	2,2	1,6	2,1	9,8		27,3	25,2	23,3	21,4	19,5	17,3	14,8	11,9	8,5		Rp 1"1/2	DN32 PN10 / 6 DN40 PNG	38	6		
GRINDER FX 15.15 TNA	60191259	3x400V	2,1	1,6	2,1	3,8		27,3	25,2	23,3	21,4	19,5	17,3	14,8	11,9	8,5		Rp 1"1/2	DN32 PN10 / 6 DN40 PNG	38	6		
GRINDER FX 15.22 TNA	60191279	3x400V	2,6	2,1	2,8	4,7		32,8	30,5	28,5	26,5	24,4	22,3	19,9	17,2	14,0		Rp 1"1/2	DN32 PN10 / 6 DN40 PNG	39	6		

in case of not availability please look at the replacement table at pag.224 for the correspondent old models.

## ATEX VERSION

MODEL	CODE
GRINDER FX 15.07 MNA 220-240/50 EX	60194119
GRINDER FX 15.07 TNA 400/50 EX	60194120
GRINDER FX 15.11 MNA 220-240/50 EX	60191241
GRINDER FX 15.11 TNA 400/50 EX	60194170
GRINDER FX 15.15 MNA 220-240/50 EX	60194226
GRINDER FX 15.15 TNA 400/50 EX	60194227
GRINDER FX 15.22 TNA 400/50 EX	60191280

discover **FX** complete range  
[fx.dabpumps.com](http://fx.dabpumps.com)



# FEKA FXV

SUBMERSIBLE PUMPS FOR SEWAGE

**NEW**



FEKA FXV

Submersible pump for draining sewage water in commercial building service.

It is certified for the European Union standard EN 12050-1 which applies to sewage lifting containing faecal material in buildings and construction sites. Suitable for fixed installations with a coupling or mobile if the pump is placed directly on the bottom of the tank. High-performance super Vortex impeller with integral free passage. Double mechanical seal in silicon carbide completely protected in oil chamber and not in contact with the pumped liquid. Motor shaft in AISI 304 stainless steel, resin-fastened cable gland. The reduced overall dimensions and the outlet ports both flanged and threaded make it ideal for replacements. The pump is designed for quick maintenance thanks to a constructive solution that provides easy access to the main components of the pump.

Single-phase versions with integrated capacitor, available with float for automatic operation (MA) with powers up to 1,5 kW. In the three-phase versions the protection is the user's responsibility.

ATEX version available for use in potentially explosive environments. (ATES certifications: II2G Ex db IIB T4 GB o IEC EX: Ex db IIB T4 Gb).

**Flow rate maximum** 59,7 m<sup>3</sup>/h

**Head up to** 18,5 m

**Type of pumped liquid** Waters with filamentary bodies, paper or textile material in the presence of domestic or civil waste

**Free passage**

50 mm or 65 mm depending on the model

**Supported liquid temperature (max)**

+50°C (+60°C for a short period of time)

+40°C for ATEX version

**Flanged and threaded** From 2", DN 50, DN 65

**Impeller type** Vortex

**Class of protection** IP 68

**Motor insulation class** F

**Dry run time** 10 min

**Possible type of installation**

mobile when on the ground, fixed with coupling

**Special versions on request** Different cable lengths, different voltages and frequencies

REPLACEMENT  
TABLE  
PAG. 224

PANELS  
PAG. 254

ACCESSORIES  
PAG. 243

## FEKA FXV 20

MODEL	CODE	ELECTRICAL DATA					HYDRAULIC DATA										DNM		FREE PASSAGE	WEIGHT KG	Q.TY x PALLET
		VOLTAGE 50 Hz	P1 MAX kW	P2 NOMINAL		In A	Q=m <sup>3</sup> /h	0	6	12	18	24	30	36	42	GAS	DN1				
FEKA FXV 20.07 MA	60191210	1x230V	1,4	0,9	1,2	6,4	H (m)	11,7	10,9	9,6	7,7	5,4	2,9			Rp 2"	50 PN10/6	50	35	6	
FEKA FXV 20.07 MNA	60191208	1x230V	1,4	0,9	1,2	6,4		11,7	10,9	9,6	7,7	5,4	2,9			Rp 2"	50 PN10/6	50	35	6	
FEKA FXV 20.07 TNA	60191209	3x400V	1,4	0,9	1,2	2,4		11,7	10,9	9,6	7,7	5,4	2,9			Rp 2"	50 PN10/6	50	35	6	
FEKA FXV 20.11 MA	60191229	1x230V	1,7	1,2	1,6	8		13,1	12,9	11,9	10,1	7,7	4,8			Rp 2"	50 PN10/6	50	35	6	
FEKA FXV 20.11 MNA	60191227	1x230V	1,7	1,2	1,6	8		13,1	12,9	11,9	10,1	7,7	4,8			Rp 2"	50 PN10/6	50	35	6	
FEKA FXV 20.11 TNA	60191228	3x400V	1,6	1,2	1,6	2,9		13,1	12,9	11,9	10,1	7,7	4,8			Rp 2"	50 PN10/6	50	35	6	
FEKA FXV 20.15 MA	60194185	1x230V	2,3	1,7	2,3	10,5		16,2	15,6	14,4	12,6	10,4	7,7	4,7			Rp 2"	50 PN10/6	50	39	6
FEKA FXV 20.15 MNA	60194186	1x230V	2,3	1,7	2,3	10,5		16,2	15,6	14,4	12,6	10,4	7,7	4,7			Rp 2"	50 PN10/6	50	39	6
FEKA FXV 20.15 TNA	60191261	3x400V	2,2	1,7	2,3	4		16,2	15,6	14,4	12,6	10,4	7,7	4,7			Rp 2"	50 PN10/6	50	39	6
FEKA FXV 20.22 TNA	60191265	3x400V	2,9	2,2	2,9	5		18,5	18,0	17,1	15,9	14,3	12,2	9,7	6,6		Rp 2"	50 PN10/6	50	40	6

in case of not availability please look at the replacement table at pag.224 for the correspondent old models.

## ATEX VERSION

MODEL	CODE
FEKA FXV 20.07 MNA 220-240/50 EX	60194085
FEKA FXV 20.07 TNA 400/50 EX	60194086
FEKA FXV 20.11 MNA 220-240/50 EX	60194135
FEKA FXV 20.11 TNA 400/50 EX	60194136
FEKA FXV 20.15 MNA 220-240/50 EX	60194187
FEKA FXV 20.15 TNA 400/50 EX	60194189
FEKA FXV 20.22 TNA 400/50 EX	60194248

discover **FX** complete range  
[fx.dabpumps.com](http://fx.dabpumps.com)



# FEKA FXV

SUBMERSIBLE PUMPS FOR SEWAGE



## FEKA FXV 25

MODEL	CODE	ELECTRICAL DATA					HYDRAULIC DATA														DNM		FREE PASSAGE	WEIGHT KG	Q.TY x PALLET								
		VOLTAGE 50 Hz	P1 MAX kW	P2 NOMINAL		In A	Q=m <sup>3</sup> /h		0		6		12		18		24		30		36					42		48		54		GAS	DN1
				kW	HP		0	100	200	300	400	500	600	700	800	900	0	100	200	300	400	500				600	700	800	900				
FEKA FXV 25.07.4 TNA	60191269	3x400V	1	0,7	0,9	2,2	H (m)	6,3	6,0	5,5	4,8	3,9	2,9	1,8														-	65 PN10/6	65	45	6	
FEKA FXV 25.12.4 TNA	60191271	3x400V	1,7	1,2	1,6	3		9,0	8,7	8,3	7,8	7,1	6,3	5,4	4,3	3,2	1,9											-	65 PN10/6	65	48	6	
FEKA FXV 25.07 MA	60196348	1x230V	1,5	1	1,3	6,6		8,8	8,1	7,0	5,7	4,3	3,0	1,8														-	65 PN10/6	65	36	6	
FEKA FXV 25.07 MNA	60196349	1x230V	1,5	1	1,3	6,6		8,8	8,1	7,0	5,7	4,3	3,0	1,8														-	65 PN10/6	65	36	6	
FEKA FXV 25.07 TNA	60196351	3x400V	1,3	1	1,3	2,3		8,8	8,1	7,0	5,7	4,3	3,0	1,8														-	65 PN10/6	65	36	6	
FEKA FXV 25.11 MA	60191243	1x230V	1,7	1,2	1,6	7,6		11,3	10,7	9,6	8,2	6,6	4,9	3,4	2,2													-	65 PN10/6	65	37	6	
FEKA FXV 25.11 MNA	60191230	1x230V	1,7	1,2	1,6	7,6		11,3	10,7	9,6	8,2	6,6	4,9	3,4	2,2													-	65 PN10/6	65	37	6	
FEKA FXV 25.11 TNA	60191244	3x400V	1,7	1,2	1,6	3		11,3	10,7	9,6	8,2	6,6	4,9	3,4	2,2													-	65 PN10/6	65	37	6	
FEKA FXV 25.15 MA	60195811	1x230V	2,3	1,7	2,3	10,6		13,7	13,4	12,4	11,0	9,2	7,4	5,5	3,9	2,5												-	65 PN10/6	65	43	6	
FEKA FXV 25.15 MNA	60194201	1x230V	2,3	1,7	2,3	10,6		13,7	13,4	12,4	11,0	9,2	7,4	5,5	3,9	2,5												-	65 PN10/6	65	43	6	
FEKA FXV 25.15 TNA	60191263	3x400V	2,2	1,7	2,3	4		13,7	13,4	12,4	11,0	9,2	7,4	5,5	3,9	2,5												-	65 PN10/6	65	43	6	
FEKA FXV 25.22 TNA	60191267	3x400V	2,8	2,2	2,9	4,9		16,5	16,3	15,6	14,5	13,0	11,3	9,4	7,5	5,6	3,8											-	65 PN10/6	65	41	6	

in case of not availability please look at the replacement table at pag.224 for the correspondent old models.

## ATEX VERSION

MODEL	CODE
FEKA FXV 25.07.4 TNA 400/50 EX	60191270
FEKA FXV 25.12.4 TNA 400/50 EX	60191272
FEKA FXV 25.07 MNA 220-240/50 EX	60196350
FEKA FXV 25.07 TNA 400/50 EX	60196352
FEKA FXV 25.11 MNA 220-240/50 EX	60194139
FEKA FXV 25.11 TNA 400/50 EX	60194194
FEKA FXV 25.15 MNA 220-240/50 EX	60194202
FEKA FXV 25.15 TNA 400/50 EX	60194241
FEKA FXV 25.22 TNA 400/50 EX	60194255

# FEKA FXC

SUBMERSIBLE PUMPS FOR EFFLUENT



**NEW**



FEKA **FXC**

Submersible pump for the lifting and re-launching of waste water coming from drains in commercial building service.

The pump is certified according to the wastewater standard EN12050-2. Pump suitable for fixed installations with a coupling or mobile device if placed on the bottom of the tank itself. Channel impeller, 50 mm free passage and anti-lock system. Suitable for waste water and waste water without the presence of long fibres, rain water and ground water. The pump is suitable for draining environments subject to flooding, when high flow rates are required. Double mechanical silicon carbide seal completely protected in oil chamber and not in contact with the pumped liquid. AISI 304 stainless steel motor shaft, resin-fastened cable gland, quick-coupling power cable.

The small size and both flanged and threaded discharge ports make it ideal for replacements. Maintenance is fast due to its design that allows easy access to the pump's main components.

Single-phase versions with integrated condenser, available with float for automatic operation (MA) with power up to 1,5 kW. In the three-phase versions the protection is the user's responsibility.

ATEX version available for use in potentially explosive environments. (ATEX certifications: II2G Ex db IIB T4 GB o IEC EX: Ex db IIB T4 Gb).

**Flow rate maximum** 71,4 m<sup>3</sup>/h

**Head up to** 19,3 m

**Type of pumped liquid** clear water, rainwater and sandy water from construction site

**Free passage** 50 mm

**Supported liquid temperature (max)**  
+50°C (+60°C for a short period of time)  
+40°C for ATEX version

**Flanged and threaded** From 2", DN 50, DN 65

**Impeller type** Channel

**Class of protection** IP 68

**Motor insulation class** F

**Dry run time** 10 min

**Possible type of installation**  
mobile when on the ground, fixed with coupling

**Special versions on request** Different cable lengths, different voltages and frequencies

REPLACEMENT  
TABLE  
PAG. 224

PANELS  
PAG. 254

ACCESSORIES  
PAG. 243

## FEKA FXC 20

MODEL	CODE	ELECTRICAL DATA				HYDRAULIC DATA										DNM		FREE PASSAGE mm	WEIGHT KG	Q.TY x PALLET			
		VOLTAGE 50 Hz	P1 MAX kW	P2 NOMINAL		In A	Q=m <sup>3</sup> /h	H (m)													GAS	DN1	
				kW	HP			0	7	14	22	29	36	43	50	58	65						0
FEKA FXC 20.07 MA	60191213	1x230V	0,9	0,7	0,9	4,1	9,8	8,3	6,7	5,1	3,6	2,4							Rp 2"	50 PN10/6	50	37	6
FEKA FXC 20.07 MNA	60191211	1x230V	0,9	0,7	0,9	4,1	9,8	8,3	6,7	5,1	3,6	2,4							Rp 2"	50 PN10/6	50	37	6
FEKA FXC 20.07 TNA	60191212	3x400V	0,9	0,7	0,9	1,8	9,8	8,3	6,7	5,1	3,6	2,4							Rp 2"	50 PN10/6	50	37	6
FEKA FXC 20.11 MA	60191233	1x230V	1,4	1	1,3	6,3	12,4	10,8	9,3	7,8	6,4	5,0	3,6						Rp 2"	50 PN10/6	50	37	6
FEKA FXC 20.11 MNA	60191231	1x230V	1,4	1	1,3	6,3	12,4	10,8	9,3	7,8	6,4	5,0	3,6						Rp 2"	50 PN10/6	50	37	6
FEKA FXC 20.11 TNA	60191232	3x400V	1,3	1	1,3	2,6	12,4	10,8	9,3	7,8	6,4	5,0	3,6						Rp 2"	50 PN10/6	50	37	6
FEKA FXC 20.15 MA	60191251	1x230V	2	1,5	2,0	9,1	15,3	13,5	11,8	10,2	8,7	7,1	5,7	4,2					Rp 2"	50 PN10/6	50	42	6
FEKA FXC 20.15 MNA	60191249	1x230V	2	1,5	2,0	9,1	15,3	13,5	11,8	10,2	8,7	7,1	5,7	4,2					Rp 2"	50 PN10/6	50	42	6
FEKA FXC 20.15 TNA	60191250	3x400V	1,8	1,5	2,0	3,5	15,3	13,5	11,8	10,2	8,7	7,1	5,7	4,2					Rp 2"	50 PN10/6	50	42	6
FEKA FXC 20.22 TNA	60191273	3x400V	2,8	2,2	2,9	4,9	19,1	17,2	15,5	14,0	12,6	11,2	9,8	8,1	6,2				Rp 2"	50 PN10/6	50	43	6

in case of not availability please look at the replacement table at pag.224 for the correspondent old models.

## ATEX VERSION

MODEL	CODE
FEKA FXC 20.07 MNA 220-240/50 EX	60194089
FEKA FXC 20.07 TNA 400/50 EX	60194090
FEKA FXC 20.11 MNA 220-240/50 EX	60194140
FEKA FXC 20.11 TNA 400/50 EX	60194141
FEKA FXC 20.15 MNA 220-240/50 EX	60194203
FEKA FXC 20.15 TNA 400/50 EX	60194204
FEKA FXC 20.22 TNA 400/50 EX	60194267

discover **FX** complete range  
[fx.dabpumps.com](http://fx.dabpumps.com)





# FEKA FXC

SUBMERSIBLE PUMPS FOR EFFLUENT



## FEKA FXC 25

MODEL	CODE	ELECTRICAL DATA					HYDRAULIC DATA													DNM		FREE PASSAGE mm	WEIGHT KG	Q.TY x PALLET							
		VOLTAGE 50 Hz	P1 MAX kW	P2 NOMINAL		In A	Q=m <sup>3</sup> /h		7		14		22		29		36		43		50				58		65		GAS	DN1	
				kW	HP		0	120	240	360	480	600	720	840	960	1080															
FEKA FXC 25.07 MA	60191216	1x230V	0,9	0,6	0,8	4,1	9,4	7,8	6,2	4,6	3,3	2,2	1,4													-	65 PN10/6	50	37	6	
FEKA FXC 25.07 MNA	60191214	1x230V	0,9	0,6	0,8	4,1	9,4	7,8	6,2	4,6	3,3	2,2	1,4													-	65 PN10/6	50	37	6	
FEKA FXC 25.07 TNA	60191215	3x400V	0,9	0,6	0,8	1,8	9,4	7,8	6,2	4,6	3,3	2,2	1,4													-	65 PN10/6	50	37	6	
FEKA FXC 25.11 MA	60191236	1x230V	1,4	1,1	1,5	6,4	11,9	10,3	8,8	7,4	6,0	4,8	3,5	2,4												-	65 PN10/6	50	38	6	
FEKA FXC 25.11 MNA	60191234	1x230V	1,4	1,1	1,5	6,4	11,9	10,3	8,8	7,4	6,0	4,8	3,5	2,4												-	65 PN10/6	50	38	6	
FEKA FXC 25.11 TNA	60191235	3x400V	1,4	1,1	1,5	2,6	11,9	10,3	8,8	7,4	6,0	4,8	3,5	2,4												-	65 PN10/6	50	38	6	
FEKA FXC 25.15 MA	60191254	1x230V	2	1,6	2,1	9,3	15,1	13,5	11,8	10,3	8,8	7,3	5,8	4,5	3,1											-	65 PN10/6	50	43	6	
FEKA FXC 25.15 MNA	60191252	1x230V	2	1,6	2,1	9,3	15,1	13,5	11,8	10,3	8,8	7,3	5,8	4,5	3,1											-	65 PN10/6	50	43	6	
FEKA FXC 25.15 TNA	60191253	3x400V	1,9	1,6	2,1	3,6	15,1	13,5	11,8	10,3	8,8	7,3	5,8	4,5	3,1											-	65 PN10/6	50	43	6	
FEKA FXC 25.22 TNA	60191275	3x400V	2,9	2,3	3,1	5	18,9	16,9	15,2	13,8	12,4	11,1	9,8	8,4	6,9	5,1										-	65 PN10/6	50	44	6	

in case of not availability please look at the replacement table at pag.224 for the correspondent old models.

## ATEX VERSION

MODEL	CODE
FEKA FXC 25.07 MNA 220-240/50 EX	60194099
FEKA FXC 25.07 TNA 400/50 EX	60194100
FEKA FXC 25.11 MNA 220-240/50 EX	60194150
FEKA FXC 25.11 TNA 400/50 EX	60194151
FEKA FXC 25.15 MNA 220-240/50 EX	60194211
FEKA FXC 25.15 TNA 400/50 EX	60194212
FEKA FXC 25.22 TNA 400/50 EX	60194274

# REPLACEMENT TABLE

NOVA - FEKA - DRENAG FX - GRINDER FX - FEKA FXV - FEKA FXC

The closest alternative to hydraulic performance is suggested in the tables of the individual pump models.

The suggested models are chosen by averaging the performance over the entire operating range of the individual pumps, **for the precise work points and for the best solution, we suggest you to referring to the technical catalog or to our DNA (DAB Navigator Application).**

In case of replacement, **the absorption and the calibration of the electrical panel should be evaluated.**

We also recommend checking **the overall dimensions** of the pump with the existing system.

NOVA	
MODEL	CODE
NOVA 180 MA	103002684
NOVA 180 MNA	103002694
NOVA 200 MNA	103002704
NOVA 300 MA	103002724
NOVA 600 MA	103002744
NOVA 600 MNA	103002754
NOVA 600 TNA	103005814

NOVA 40th	
MODEL	CODE
NOVA 180 MA 40th	60195073
NOVA 180 MNA 40th	60195632
NOVA 200 MNA 40th	60194402
NOVA 300 MA 40th	60194400
NOVA 600 MA 40th	60191566
NOVA 600 MNA 40th	60195636
NOVA 600 TNA 40th	60196306

GRINDER 1400-1800/GRINDER 1000-1600	
MODEL	CODE
GRINDER 1000 MA	60141604
GRINDER 1000 MNA	60141603
GRINDER 1000 T	60141602
GRINDER 1200 MA	60141601
GRINDER 1200 MNA	60141600
GRINDER 1200 TNA	60141599
GRINDER 1400 M	103010440
GRINDER 1600 T	60141588
GRINDER 1800 T	103010560

GRINDER FX 15	
MODEL	CODE
GRINDER FX 15.07 MA	60191222
GRINDER FX 15.07 MNA	60191220
GRINDER FX 15.07 TNA	60191221
GRINDER FX 15.11 MA	60191242
GRINDER FX 15.11 MNA	60191240
GRINDER FX 15.11 TNA	60191278
GRINDER FX 15.11 MNA	60191240
GRINDER FX 15.11 TNA	60191278
GRINDER FX 15.15 MNA	60191258
GRINDER FX 15.15 TNA	60191259
GRINDER FX 15.22 TNA	60191279

FEKA	
MODEL	CODE
FEKA 600 MA	103002774
FEKA 600 MNA	103002784
FEKA 600 TNA	103005824

FEKA 40th	
MODEL	CODE
FEKA 300 MA 40th	60191897
FEKA 300 MNA 40th	60195558
FEKA 600 MA 40th	60190343
FEKA 600 MNA 40th	60194419
FEKA 600 TNA 40th	60196308

FEKA 1400-1800 / FEKA 2000	
MODEL	CODE
FEKA 2015.2 M	60145478
FEKA 2015.2 MNA	60145479
FEKA 2015.2 T	60145480
FEKA 1400 M	103010240
FEKA 1800 T	103010360
FEKA 2025.2 T	60145481
FEKA 2030.2 T	60145482

FEKA FXV 20	
MODEL	CODE
FEKA FXV 20.07 MA	60191210
FEKA FXV 20.07 MNA	60191208
FEKA FXV 20.07 TNA	60191209
FEKA FXV 20.11 MA	60191229
FEKA FXV 20.11 MNA	60191227
FEKA FXV 20.11 TNA	60191228
FEKA FXV 20.15 MA	60194185
FEKA FXV 20.15 MNA	60194186
FEKA FXV 20.15 TNA	60191261
FEKA FXV 20.22 TNA	60191265

DRENAG 1400-1800	
MODEL	CODE
DRENAG 1400 M	103010040
DRENAG 1800 T	103010160

DRENAG FX 15	
MODEL	CODE
DRENAG FX 15.07 MA	60191219
DRENAG FX 15.07 MNA	60191217
DRENAG FX 15.07 TNA	60191218
DRENAG FX 15.11 MA	60191239
DRENAG FX 15.11 MNA	60191237
DRENAG FX 15.11 TNA	60191238
DRENAG FX 15.15 MA	60191257
DRENAG FX 15.15 MNA	60191255
DRENAG FX 15.15 TNA	60191256
DRENAG FX 15.22 TNA	60191277

FEKA 2500	
MODEL	CODE
FEKA 2515.4T	60141724
FEKA 2500.4T	103018080
FEKA 2515.2T	60141726
FEKA 2500.2 T	103018000
FEKA 2700.2 T	103018040

FEKA FXV 25	
MODEL	CODE
FEKA FXV 25.07.4 TNA	60191269
FEKA FXV 25.12.4 TNA	60191271
FEKA FXV 25.07 MA	60196348
FEKA FXV 25.07 MNA	60196349
FEKA FXV 25.07 TNA	60196351
FEKA FXV 25.11 MA	60191243
FEKA FXV 25.11 MNA	60191230
FEKA FXV 25.11 TNA	60191244
FEKA FXV 25.15 TNA	60191263
FEKA FXV 25.22 TNA	60191267

DRENAG 1600 - 3000	
MODEL	CODE
DRENAG 1600 M-A	60141710
DRENAG 1600 T-NA	60141711
DRENAG 2000 T-NA	60141712
DRENAG 2500 T-NA	60141713
DRENAG 3000 T-NA	60141714

FEKA FXC 25	
MODEL	CODE
FEKA FXC 25.07 MA	60191216
FEKA FXC 25.07 MNA	60191214
FEKA FXC 25.07 TNA	60191215
FEKA FXC 25.11 MA	60191236
FEKA FXC 25.11 MNA	60191234
FEKA FXC 25.11 TNA	60191235
FEKA FXC 25.15 MA	60191254
FEKA FXC 25.15 MNA	60191252
FEKA FXC 25.15 TNA	60191253
FEKA FXC 25.22 TNA	60191275
FEKA FXC 25.22 TNA	60191275

## FK

## SUBMERSIBLE PUMPS



Design for the pumping of wastewater and sewage from buildings and sites in private, commercial, industrial areas in accordance with European Standard EN 12050-1.

Vortex impeller with maximum solids handling with new no-clogging shape, single channel impeller with high efficiency and compliance with European Standard EN 12050-1. Single-unit cartridge seal with double mechanical seals, SiC-SiC at the pump side, SiC-C at the motor side. All seals are independent of rotation direction. DN 65, DN 80, DN 100 radial slot EN 1092-1 flange discharge.

Liquid Viscosity : 1mm<sup>2</sup>/s. Premium Efficiency IE3, three-phase, squirrel-cage motor. Continuously S1 rated motor in submerged applications, or discontinuous S3 according to minimum levels. Seal monitoring by a moisture sensor in the seal chamber, which signals an inspection alert if there is leakage at the mechanical seals (optional). Bi-metallic switch in stator windings, with max temperature (150°C). Stainless steel shaft. Designed with high resistance fatigue fracture.

Available in Ex version for use in potentially explosive atmosphere (ATEX certifications: II2G Ex db k IIB T4 or IECEx: Ex db IIB T4 Gb).

**Impeller type FKV:** Vortex.

**FKC:** Single channel.

**Solid handling** 65 ÷ 100 mm

**Nominal power** 1,1 ÷ 11 kW

**Outlet** DN 65 / 80 / 100 / 150

**Performance range**

from 4.3 to 280 m<sup>3</sup>/h with 41 meters head.

**Fluid** wastewater and sewage from buildings and sites in private, commercial, industrial areas.

**Fluid PH** 6.5 ÷ 12.

**Fluid temperature range** from 0° to +40°C.

For higher temperature please contact our sale offices.

**Max installation depth**

20 mt (with a proper cable length).

**Type of installation** fixed by Coupling Unit, portable in vertical position with pedestal. Continuous working with total submerged applications, or discontinuous S3 with respect of minimum levels.

**Approvals** EN 12050-1 e Ex (ATEX , IECEx).

**Degree of protection** IP 68

**Insulation class** F

**Max starting / hours** 20

PANELS  
PAG. 254

ACCESSORIES  
PAG. 243



ENERGY EFFICIENCY **IE3**

### NEW IE3 MOTORS

The new **IE3 premium efficiency motors** drastically reduce energy operation costs. Given the low running temperatures, it is guaranteed their operation up to 40°C, for higher temperatures please contact the sales department.

Thermal protection is standard and they have an insulation class equas to F.



### SINGLE-UNIT CARTRIDGE SEAL

A single-unit cartridge seal is a great advantage for maintenance of the pump as allows the removal and insertion of the seals in less time, having a total guarantee to carry out properly. It's an **exclusive patent DAB**: a double mechanical seal Sic-Sic with opposite faces, independent from the rotation direction of shaft, with Viton elastomers and leap seal.



**EN 12050-1**

### NEW NO-CLOGGING VORTEX IMPELLER

The guarantee of operation comes before efficiency. A new design of the Vortex impellers and the total solid handling are respectively the two guarantees to have no-clogging issues.

**Compliant with EN 12050-1**



**EN 12050-1**

### NEW SINGLE CHANNEL HYDRAULICS

The new high efficiency single-channel hydraulic has been designed especially for continuous wastewater operations with high flow demand and low fiber content.

**Compliant with EN 12050-1**

## FK

SUBMERSIBLE PUMPS



## FKV 65

MODEL	STANDARD	OIL SENSOR	Ex (ATEX)	ELECTRICAL DATA				HYDRAULIC DATA												DNM	FREE PASSAGE mm	WEIGHT KG						
	CODE	CODE	CODE	VOLTAGE 50 Hz	P1 MAX kW	P2 NOM. kW HP	In A	Q=m³/h	0	8	16	23	31	39	47	55	62	72	Q=l/min				0	130	260	390	520	650
FKV 65.11.4 T5	60172586	60176718	60178992	3x400 V DOL	1,3	1,1 1,5	3,3	H (m)	9,1	8,7	7,7	6,4	4,9	3,4	2,2						65	55	105					
FKV 65 22.2 T5	60171422	60176719	60178993	3x400 V DOL	2,5	2,2 3	4,8		16,5	14,1	11,4	8,5	5,8	3,5	2,1						65	65	105					
FKV 65 30.2 T5	60170389	60176720	60176081	3x400 V DOL	3,3	3 4	5,7		21,1	19,3	16,6	13,4	10,0	6,9	4,3	2,6					65	65	105					
FKV 65 40.2 T5	60171423	60172163	60178994	3x400 V DOL	4,6	4 5,5	7,5		27,2	25,8	23,5	20,6	17,2	13,7	10,3	7,2	4,8	3,0			65	65	147					

## FKV 80

MODEL	STANDARD	OIL SENSOR	Ex (ATEX)	ELECTRICAL DATA				HYDRAULIC DATA												DNM	FREE PASSAGE mm	WEIGHT KG						
	CODE	CODE	CODE	VOLTAGE 50 Hz	P1 MAX kW	P2 NOM. kW HP	In A	Q=m³/h	0	12	24	36	48	60	72	84	96	108	Q=l/min				0	200	400	600	800	1000
FKV 80 11.4 T5	60171443	60176715	60178995	3x400 V DOL	1,3	1,1 1,5	3,5	H (m)	7,0	6,3	5,0	3,6	2,1								80	80	114					
FKV 80 15.4 T5	60171444	60176716	60178996	3x400 V DOL	1,8	1,5 2,0	3,8		9,3	9,0	7,8	6,1	4,2	2,7	1,9						80	80	114					
FKV 80 22.4 T5	60170418	60176717	60178997	3x400 V DOL	2,5	2,2 3,0	4,7		11,5	11,4	10,5	9,1	7,3	5,4	3,7						80	80	115					
FKV 80 40.4 T5	60171445	60172165	60178998	3x400 V DOL	4,5	4,0 5,5	8,6		17,5	16,7	15,5	14,0	12,4	10,7	9,0	7,4					80	80	170					
FKV 80 40.2 T5	60171424	60172158	60178999	3x400 V DOL	4,6	4 5,5	7,7		22,1	20,1	16,5	12,2	8,0	4,6	2,9						80	80	153					
FKV 80 60.2 T5	60171425	60172166	60179000	3x400 V Y/D	6,9	6 8,2	11,7		29,1	27,5	24,4	20,3	15,7	11,4	7,9						80	80	168					
FKV 80 75.2 T5	60170434	60172167	60179001	3x400 V Y/D	8,3	7,5 10,2	13,7		32,1	31,2	28,5	24,5	19,9	15,1	10,6	7,1	5,1				80	80	218					
FKV 80 92.2 T5	60171426	60172168	60179002	3x400 V Y/D	10,2	9,2 12,5	18		35,9	35,5	33,1	29,2	24,4	19,3	14,3	10,2	7,3				80	80	218					
FKV 80 110.2 T5	60170429	60172169	60179003	3x400 V Y/D	12,1	11 15	21		40,9	40,7	38,7	35,2	30,6	25,6	20,3	15,5	11,4	8,5			80	80	218					

## FKV 100

MODEL	STANDARD	OIL SENSOR	Ex (ATEX)	ELECTRICAL DATA				HYDRAULIC DATA												DNM	FREE PASSAGE mm	WEIGHT KG						
	CODE	CODE	CODE	VOLTAGE 50 Hz	P1 MAX kW	P2 NOM. kW HP	In A	Q=m³/h	0	15	30	45	60	75	90	105	126	144	Q=l/min				0	250	500	750	1000	1250
FKV 100 30.4 T5	60171446	60172170	60179004	3x400 V DOL	3,5	3 4	8	H (m)	11,8	10,9	9,6	8,0	6,2	4,6	3,1						100	100	167					
FKV 100 40.4 T5	60171447	60172171	60179005	3x400 V DOL	4,5	4 5,5	8,9		14,0	13,1	11,9	10,4	8,8	7,1	5,4	3,9					100	100	167					
FKV 100 55.4 T5	60171448	60172172	60179006	3x400 V Y/D	6,2	5,5 7,5	11,3		15,9	15,5	14,8	13,7	12,3	10,8	9,2	7,5	5,4				100	100	221					
FKV 100 75.4 T5	60170428	60172173	60179007	3x400 V Y/D	8,3	7,5 10	14,3		19	18,8	18,3	17,4	16,3	15	13,5	11,9	9,6	7,7			100	100	221					

Power input: 3x400V DOL direct start-up, 3x400V Y/D star-delta start-up.  
All models are available with 230V power input voltage and Y/D or DOL start-up.

## FK

SUBMERSIBLE PUMPS



## FKC 65

MODEL	STANDARD	OIL SENSOR	Ex (ATEX)	ELECTRICAL DATA				HYDRAULIC DATA											DNM	FREE PASSAGE mm	WEIGHT KG								
	CODE	CODE	CODE	VOLTAGE 50 Hz	P1 MAX kW	P2 NOM. kW	In HP	In A	Q=m³h	0	9,6	19,2	28,8	38,4	48	57,6	67,2	76,8				90	Q=l/min	0	160	320	480	640	800
FKC 65 22.2 T5	60176795	60180431	60180454	3x400 V DOL	2,6	2,2	3	4,8	H (m)	20,0	17,1	14,8	12,8	11,2	9,7	8,3	6,8	5,3	2,8	65	50	104							
FKC 65 30.2 T5	60176857	60180439	60180462	3x400 V DOL	3,4	3	4	5,8		26,5	22,6	19,4	16,7	14,6	12,8	11,2	9,8	8,2	5,8	65	50	104							

## FKC 80

MODEL	STANDARD	OIL SENSOR	Ex (ATEX)	ELECTRICAL DATA				HYDRAULIC DATA											DNM	FREE PASSAGE mm	WEIGHT KG								
	CODE	CODE	CODE	VOLTAGE 50 Hz	P1 MAX kW	P2 NOM. kW	In HP	In A	Q=m³h	0	21	42	63	84	105	126	147	168				189	Q=l/min	0	350	700	1050	1400	1750
FKC 80 15.4 T5	60176796	60180432	60180455	3x400 V DOL	1,8	1,5	2	3,5	H (m)	8,9	7,4	6,2	5,0	3,8	2,5						80	80	116						
FKC 80 22.4 T5	60176858	60180440	60180463	3x400 V DOL	2,6	2,2	3	4,7		13,9	11,3	9,3	7,6	6,2	4,7	2,9						80	80	116					
FKC 80 30.4 T5	60176871	60180443	60180466	3x400 V DOL	3,6	3	4	7,6		13,9	11,8	10,1	8,7	7,4	6,1	4,7	3,0					80	80	183					
FKC 80 40.4 T5	60176872	60180444	60180467	3x400 V DOL	4,7	4	5,5	8,9		17,4	15,0	13,1	11,5	10,2	8,9	7,6	6,2					80	80	182					
FKC 80 55.4 T5	60176854	60180437	60180460	3x400 V Y/D	6,3	5,5	7,5	8,6		21	18,8	16,8	15,1	13,5	12	10,6	9,3	7,9				80	80	235					
FKC 80 75.4 T5	60176855	60180438	60180461	3x400 V Y/D	8,5	7,5	10	14,1	24,6	21,9	19,7	17,8	16	14,5	13	11,5	9,8	8			80	80	237						

## FKC 100

MODEL	STANDARD	OIL SENSOR	Ex (ATEX)	ELECTRICAL DATA				HYDRAULIC DATA											DNM	FREE PASSAGE mm	WEIGHT KG								
	CODE	CODE	CODE	VOLTAGE 50 Hz	P1 MAX kW	P2 NOM. kW	In HP	In A	Q=m³h	0	30	60	90	120	150	180	210	240				288	Q=l/min	0	500	1000	1500	2000	2500
FKC 100 15.4 T5	60176859	60180441	60180464	3x400 V DOL	1,8	1,5	2	3,9	H (m)	8,9	6,8	5,0	3,3								100	100	117						
FKC 100 22.4 T5	60176860	60180442	60180465	3x400 V DOL	2,6	2,2	3	4,7		14,1	10,7	8,1	6,0	3,9								100	100	117					
FKC 100 30.4 T5	60176873	60180445	60180468	3x400 V DOL	3,3	3	4	7,7		9,8	9,0	7,9	6,8	5,5	4,2	3,0						100	100	190					
FKC 100 40.4 T5	60176874	60180446	60180469	3x400 V DOL	4,2	4	5,5	8,6		13,1	11,4	9,8	8,3	6,9	5,4	4,0						100	100	190					
FKC 100 55.4 T5	60176850	60180434	60180457	3x400 V Y/D	5,7	5,5	7,5	11,4		17,4	15,4	13,5	11,8	10,2	8,7	7,1	5,5	3,9				100	100	238					
FKC 100 75.4 T5	60176851	60180435	60180458	3x400 V Y/D	8,1	7,5	10	14,6		22,5	20,1	18	16	14,2	12,5	10,9	9,2	7,5	4,6			100	100	238					



## FKC 150

MODEL	STANDARD	OIL SENSOR	Ex (ATEX)	ELECTRICAL DATA				HYDRAULIC DATA											DNM	FREE PASSAGE mm	WEIGHT KG								
	CODE	CODE	CODE	VOLTAGE 50 Hz	P1 MAX kW	P2 NOM. kW	In HP	In A	Q=m³h	0	36	72	108	144	180	216	252	288				324	Q=l/min	0	600	1200	1800	2400	3000
FKC 150 30.4 T5	60177074	60180448	60180471	3x400 V DOL	3,7	3	4,1	7,8	H (m)	9,7	8,7	7,6	6,3	5,0	3,5	2,1					150	100	193						
FKC 150 40.4 T5	60176875	60180447	60180470	3x400 V DOL	4,5	4	5,5	8,7		13,3	11,4	9,8	8,1	6,6	5,0	3,3	1,5					150	100	193					
FKC 150 55.4 T5	60176852	60180436	60180459	3x400 V Y/D	6	5,5	7,5	11,3		17,3	14,8	12,7	10,9	9,3	7,7	6,2	4,7	2,9				150	100	240					
FKC 150 75.4 T5	60176853	60180433	60180456	3x400 V Y/D	8,4	7,5	10,1	14,7		22,5	19,6	17,2	15	13,1	11,4	9,7	8,1	6,3	4,3			150	100	242					

Power input: 3x400V DOL direct start-up, 3x400V Y/D star-delta start-up.

All models are available with 230V power input voltage and Y/D or DOL start-up.

## ACCESSORIES AND OPTIONS

RINGSTAND	FKC 65	FKV 65/80	FKC 80 FKV 100	FKC 100/150	DESCRIPTION	CODE	WEIGHT Kg
	●				RINGSTAND 0325 FK	60170329	10,5
		●			RINGSTAND 0330 FK	60170330	10,5
			●	up to 2.2kW	RINGSTAND 0355 FK	60170331	11,4
			●	above 2.2kW	RINGSTAND 0400 FK	60184584	10,3

MODEL	CODE
CABLE 20MT - 4G1.5+3X1 07RN8-F	on request
CABLE 30MT - 4G1.5+3X1 07RN8-F	on request
CABLE 50MT - 4G1.5+3X1 07RN8-F	on request
CABLE 20MT - 7G2,5+3X1 07RN8-F	on request
CABLE 30MT - 7G2,5+3X1 07RN8-F	on request
CABLE 50MT - 7G2,5+3X1 07RN8-F	on request
OR FKM (VITON®)	on request

# FEKA 6200/ 6300/ 8100/ 8200/ 8300

SEWAGE PUMPS



FEKA 6200



SINGLE CHANNEL IMPELLER

Cast iron submersible pumps with vortex impeller for sewage single channel impeller (6000 vers.) and three vane impeller (8000 vers.), suitable for foul waste water with solid contents with **80-108 mm** as maximum diameter.

Motor body, hydraulic section and any impeller in cast iron EN G.JL 200.

Double mechanical seals in oil chamber: motor side carbon/steel, pump side in silicon carbide/silicon carbide. Oil chamber with water level detector kit.

Dry type asynchronous sealed motor. Rotor mounted on ball bearings to ensure silent running and long life. Thermal and overcurrent protection are installed in the motor windings as standard.

**Motor protection rating** IP 68

**Insulation class** F

Continuous duty with completely immersed pump. Supplied as standard with **10 metre H07RN-F** power cable.

**Free passage** 80-108 mm.

**Operating range** from 36 to 780 m<sup>3</sup>/h with head up to 28 mt.

**Liquid quality requirements**

Non-aggressive sewage, drain water

**Free passage** 150 mm.

**Liquid temperature range** From 0° to + 40°.

**Maximum immersion depth** 20 mt

**Installation** in vertical position.



FEKA 8000



THREE VANE IMPELLER

PANELS  
PAG. 254

ACCESSORIES  
PAG. 243

MODEL	CODE	ELECTRICAL DATA						HYDRAULIC DATA																	DNM	FREE PASSAGE mm					
		VOLTAGE 50 HZ	STA.	P1 MAX KW	P2 NOMIN.		In A	Q=m <sup>3</sup> /h																							
					kW	HP		0	24	36	48	60	72	90	108	126	150	180	210	240	270	300	360	420			480	600	780		
FEKA 6200.4T	103019050	3X400 V~	Y/	15,8	14,9	19,9	30	21	20,5	20,3	20	19,5	18,8	18,2	17,4	16,2	15,5	14,1	12,8	11,8	10,2	8,4	4,2							150	95
FEKA 6250.4T	103019060	3X400 V~	Y/	24	18,5	24,7	40	25	24,7	24,5	24,2	24	23,5	23	22,5	22	21,5	20,5	19,5	18,5	17	16	14	11						150	108
FEKA 6300.4T	103019070	3X400 V~	Y/	23	21	28	45	26	24,9	24	23,8	23,4	23	22	21	20,5	19,8	19	18	16,8	16	14,4	12,3	8					150	108	
FEKA 8150. 6T	60141737	3X400 V~	Y/	10,7	8,5	11,3	22	8,53	8,05	7,83	7,6	7,45	7,3	7,15	6,9	6,7	6,45	6	5,6	5,24	4,6	4,2	3,34	2,34	1,56				200	80	
FEKA 8200. 6T	60141738	3X400 V~	Y/	13,4	11,4	15,2	27	11,2	18	10,5	10,3	9,97	9,7	9,5	9,2	8,8	8,46	8	7,4	6,95	6,3	5,6	4,4	3,6	2,67	1,07			200	80	
FEKA 8250. 6T	60141739	3X400 V~	Y/	17	13,5	18	36	14,4	14	13,7	13,5	13,2	13	12,6	12,34	12	11,52	11,1	10,6	10	9,4	8,7	7,3	6,5	5,5	3,3			200	80	
FEKA 8300. 6T	60141740	3X400 V~	Y/	22	19,3	25,7	46	17	16,6	16,2	16	15,6	15	14,7	14,5	14,2	13,8	13,5	13	12,4	12	11,4	10	9	7,6	5	2,6	200	80		

# GENIX

## AUTOMATIC LIFTING STATIONS



GENIX



GENIX WL



Its use is needful whenever the wastewater coming from the WC, the shower, the washbasin or the bidet cannot be expelled by gravity. GENIX models normally have a front WC connection. The difference in the GENIX WL is the side WC connection, specifically designed for WC wall-mounted installations or where there is no room enough behind the WC. In the model 130, beside the WC, three more lines can be connected, such as shower, washbasin, bidet or bathtub. The models offered stand out for silent running, even more improved in the Comfort version. The pump, powerful and reliable, and the grinding system, with blades in nickel plated stainless steel, make together a long lasting and basically daily maintenance-free product. Extremely easy the maintenance in case of clog or motor blocking, with the possibility to dismount the motor subassembly only operating on two screws, and with the unique discharge tap that will allow a clean, and free of problems, maintenance. In case of blockage, the motor unit can be accessed from the outside, with no need to remove the product. Extraordinary maintenance will be extremely easy, clean and without issues. The installation kit comes with easy-connect fittings adaptable to various pipe sections and including built-in non-return valves.

Available, as accessories, an acoustic alarm anti-flooding and an adaptor pipe, to adapt the GENIX to a vast majority of existing installations.

**Liquid temperature range** From 0° to +50°C.

### Liquid pumped

Sewage water containing fecal matter as regulated by EN 12050-3.

### Third parts certifications

VDE-GS, LGA, VDE-EMC.

**Tank capacity and delivery** approved for flush volumes of 6 and 9 liters as regulated by EN 12050-3.

**International Protection grade** IP44.

MODEL	CODE	ELECTRICAL DATA				HYDRAULIC DATA								H max ACCORDING EN12050-3 (m)	ADDITIONAL INLETS	DNM mm	WEIGHT KG
		VOLTAGE 50 HZ	P2 NOMINAL		In A	Q=m³h	0	0,9	1,8	3	4,2	5,4	5,7				
			kW	HP		Q=l/min	0	15	30	50	70	90	95				
GENIX 110	60165319	1 x 230 V ~	0,32	0,44	2,3	H (m)	8	7,5	6,8	5,2	3,5	1	6	1 (up)	22/25/28/ 32/36/40	10	
GENIX 130	60161880	1 x 230 V ~	0,32	0,44	2,3		8	7,5	6,8	5,2	3,5	1	6	2 (side) + 1 (up)		10,3	
GENIX COMFORT 110	60165322	1 x 230 V ~	0,32	0,44	2,3		8	7,5	6,8	5,2	3,5	1	6	1 (up)		11,2	
GENIX COMFORT 130	60165318	1 x 230 V ~	0,32	0,44	2,3		8	7,5	6,8	5,2	3,5	1	6	2 (side) + 1 (up)		11,7	
GENIX WL 110	60185327	1 x 230 V ~	0,32	0,44	2,3		8	7,5	6,8	5,2	3,5	1	6	1 (up)		10	
GENIX WL 130	60185581	1 x 230 V ~	0,32	0,44	2,3		8	7,5	6,8	5,2	3,5	1	6	2 (side) + 1 (up)		10,3	

## ACCESSORIES

	<b>ACUSTIC ALARM</b>	60166477
---	----------------------	----------



GENIX

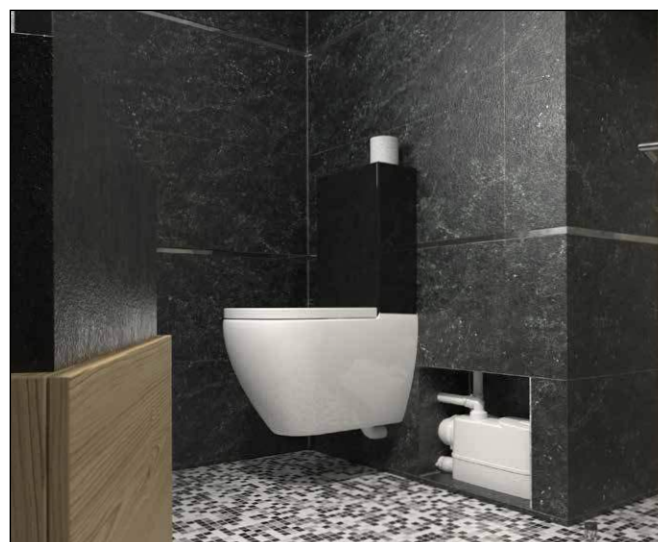

GENIX WL

discover **GENIX**  
[www.dabpumps.com/genix](http://www.dabpumps.com/genix)



# GENIX VT

AUTOMATIC LIFTING STATIONS



Its use is needful whenever the wastewater coming from the WC, the shower, the washbasin or the bidet cannot be expelled by gravity. These lifting stations can be installed wherever there is the wish to add a toilet during new installations or constructions, renovations, or structural modifications.

GENIX 110 has the facility to connect one high drain utility, like a washbasin; GENIX 130 has the facility to connect up to three utilities, even with low drain as a shower, bidet or bathtub. Our models offer silent operation and reliable performance, thanks to a powerful motor which allows to work with temperatures up to 90°C. Extremely easy the maintenance in case of clog or motor blocking, with the possibility to dismount the motor subassembly only operating on two screws, and with the unique discharge tap that will allow a clean, and free of problems, maintenance.

The non-return valves are integrated in the delivery pipe, and for the 130 models in the lateral bottom inlets. Available, as accessories, an acoustic alarm anti-flooding and an adaptor pipe, to adapt the GENIX to a vast majority of existing installations.

### Liquid temperature range

From 0°C to +75 °C up to +90°C for 30 min.

### Liquid pumped

Sewage water containing fecal matter as regulated by EN 12050-3.

### Third parts certifications: LGA

**Tank capacity and delivery:** 1-90 m<sup>3</sup>/h with dynamic head up to 8 metres

**International Protection grade:** IP44.

MODEL	CODE	ELECTRICAL DATA				HYDRAULIC DATA								H max ACCORDING EN12050-3 (m)	INLETS	DNM mm	WEIGHT KG
		VOLTAGE 50 HZ	P2 NOMINAL		In A	Q=m <sup>3</sup> /h	0	0,9	1,8	4,2	5,4	5,7	6,7				
			KW	HP		Q=l/min	0	15	30	60	90	110	130				
GENIX VT 010	60185582	1 x 230V ~	0,32	0,44	2,5	H (m)	8,8	8,4	8	6,9	4,8	3,3	1,9	6	1	22/25/28/ 32/36/40	10
GENIX VT 030	60185583	1 x 230V ~	0,32	0,44	2,5	H (m)	8,8	8,4	8	6,9	4,8	3,3	1,9	6	3		10,3

## ACCESSORIES

	ACUSTIC ALARM	60166477
---	---------------	----------



discover **GENIX**

[www.dabpumps.com/genix](http://www.dabpumps.com/genix)





# NOVABOX

SMALL LIFTING STATIONS FOR AUTOMATIC COLLECTING AND PUMPING SEWAGE



Automatic stations for collecting and lifting domestic waste water from bath tubs, wash basins, showers and washing machines located in basements or below the level of the sewage network. Equipped with a NOVA 300 electropump with 5 metres of power cable and plug mounted on a technopolymer plate, a 30-litre container in technopolymer and a check valve on delivery. Supplied with pump already assembled, ready to us

### Operating range

from 1 to 7,2 m<sup>3</sup>/h with head up to 6.9 metres

### Liquid temperature range

+50°C +90°C for a max. time of 3 min.

### Pumped liquid

waste water free from solids and/or fibres

**Pump motor protection level** IP 68

**Motor insulation class** F

MODEL	CODE	ELECTRICAL DATA				HYDRAULIC DATA			WEIGHT KG
		VOLTAGE 50 Hz	P1 MAX KW	P2 NOMINAL		In A	Q m <sup>3</sup> /h	H m	
				KW	HP				
NOVABOX 30/3001 M 40th	60196309	1x220-240 V ~	0,29	0,22	0,3	1,3	1-7,2	6,3-1	9,2

# FEKABOX 110

AUTOMATIC PUMPING STATION



Automatic collection and lifting stations. Ideal for the collection and pumping into the sewer network of dirty and domestic drain waste water from underground locations below the level of the sewer network. FEKABOX 110 consists of a polyethylene tank with an effective capacity of 110 litres, with cover fitted with plastic seal.

**The FEKABOX range is ready for the use of only one single-phase automatic pump with float that must be ordered separately, without the need for a control panel.**

### Operating range

from 1 to 24 m<sup>3</sup>/h with head up to 9 m.

**Liquid temperature range** + 50°C.

### Pumped liquid

waste water and domestic drains.

Liquids compatible with EN12050 2.

### COMPONENTS INCLUDED

- Complete pump installation kit
- Cable gland for individual pump
- 2" F x 1 x 1/4 M connector for FEKA 600

SELECTION  
TABLE  
PAG. 236

MODEL	CODE	CAPACITY [lt]	DIMENSION mm	TO BE USED WITH	DN PIPES [mm]	WEIGHT Kg.
FEKABOX 110	60164870	110	650x400x655	FEKA 600 MA, FEKA VS 550-750 MA	3xDN110, 2xDN50 inlet 1xDN50 ventilation 1xDN40 emergency emptying	10,3

- Not compatible with the alarm system.

# FEKABOX - FEKAFOS RANGE



example

## SELLING POINT

Certification according to European law 12050-1 to guarantee the watertight seal from odors and leaks

Light, but resistant to chemical and mechanical stress

Designed for easy installation and maintenance of the pump thanks to the lifting device

Tightening of the lid without the use of screws

The tank material is environmentally friendly, 100% recyclable

Designed with floats and a supplementary floating overflow alarm

The only one on the market that offers a complete professional solution with double pump also for domestic installations where space and cost are contained (FEKAFOS DOUBLE)

CK

## FEKABOX 200

AUTOMATIC PUMPING STATION



NEW MODEL



Tanks for domestic waste water arriving from drainage systems of various types or storm drains, for systems located below the sewer network such as garages or basements, when the sewers cannot be reached by gravity. The pump installed in the tank allows the waters to be conveyed into the sewer. The tank has numerous possibilities for connecting pipes at input, output and ventilation, allowing adequate use even in limited spaces. A grinder pump can also be installed in the tank, able to break up any foreign bodies in the waste water and project them at long distances.

**The FEKABOX is designed for use with just one automatic single-phase pump with float switch, which must be ordered separately.**

### COMPONENTS INCLUDED FEKABOX 200

- A lifting device 2" PP and anti-rotation bracket for FEKA VS
- Cable gland for single pump
- Connection 2" F x 1 x 1/4 M per FEKA 600
- Floating cable clamp kit FEKA VS

### COMPONENTS INCLUDED FEKABOX 200 FX

- A lifting device cast iron DA-050
- Cable gland for single pump

### Operating range

from 1 to 24 m<sup>3</sup>/h with a head of up to 15 mt.

**Maximum liquid temperature range** 45°C

**Pumped liquid** ground water, rain water, clear waste water, black waste water and water from rivers and lakes.

Liquids compatible with EN12050-1/2

**Installation** Inside or outside the building. Laid on the floor, under the ground or housed.

**Material** LLDPE

SELECTION TABLE  
PAG. 236

MODEL	CODE	CAPACITY [lt]	DIMENSION mm	TO BE USED WITH	DN PIPES [mm]	WEIGHT Kg.
FEKABOX 200	60162080	200	750x600x779	FEKA 600 M-A, FEKA VS 550-750-1000-1200 M-A	DN 50/110 inlet DN 50 ventilation G2" outlet	23,2
FEKABOX 200 FX	60198414	200	750x600x779	GRINDER FX MA, DRENAG FX MA, FEKA FXV 20 MA, FEKA FXC 20 MA	DN 50/110 inlet DN 50 ventilation G2" outlet	27

# FEKAFOS 280

AUTOMATIC PUMPING STATION



Tanks for domestic waste water arriving from drainage systems of various types or storm drains, for systems located below the sewer network such as garages or basements, when the sewers cannot be reached by gravity. The pump installed in the tank allows the waters to be conveyed into the sewer. The tank has numerous possibilities for connecting pipes at input, output and ventilation, allowing adequate use even in limited spaces. A grinder pump can also be installed in the tank, able to break up any foreign bodies in the waste water and project them at long distances.

**The FEKAFOS is designed for use with one non-automatic singlephase or three-phase pumps without float switch, which must be ordered separately together with the control panel.**

## COMPONENTS INCLUDED

- A lifting device DSD2" and anti-rotation bracket for FEKA VS
- 4 Cable glands for single pump and floats
- Connection 2" F x 1 x 1/4 M per FEKA 600
- Floating cable clamp kit FEKA VS
- 2 floating and floating alarm support

**Material** LLDPE

## Operating range

from 1 to 48 m<sup>3</sup>/h with a head of up to 23 mt.

**Maximum liquid temperature range** + 45°C

**Pumped liquid** ground water, rain water, clear waste water, black waste water and water from rivers and lakes. Liquids compatible with EN12050-1/2

**Installation** Inside or outside the building. Laid on the floor, under the ground or housed.

SELECTION  
TABLE  
PAG. 236

MODEL	CODE	CAPACITY [lt]	DIMENSION mm	TO BE USED WITH **	DN PIPES [mm]	WEIGHT Kg.
FEKAFOS 280 2"	60162044	280	750x600x940	FEKA VS 550-750-1000-1200 M-NA/T-NA, GRINDER FX MNA/TNA, DRENAG FX MNA/TNA, FEKA FXV 20 MNA/TNA, FEKA FXC 20 MNA/TNA	DN 50/110 inlet DN 50 ventilation G2" outlet	40,5

COMMAND AND  
CONTROL SYSTEMS

CIRCULATORS AND  
IN-LINE PUMPS

MULTISTAGE CENTRIFUGAL  
AND SELF-PRIMING PUMPS

SWIMMING POOL, POND AND  
SALT WATER PUMPS

CENTRIFUGAL PUMPS

SUBMERSIBLE PUMPS

SUBMERSIBLE PUMPS  
AND SUBMERSIBLE MOTORS

PRESSURE UNITS

# FEKAFOS 280 DOUBLE

AUTOMATIC PUMPING STATION



Tanks for domestic waste water arriving from drainage systems of various types or storm drains, for systems located below the sewer network such as garages or basements, when the sewers cannot be reached by gravity. The pump installed in the tank allows the waters to be conveyed into the sewer. The tank has numerous possibilities for connecting pipes at input, output and ventilation, allowing adequate use even in limited spaces. A grinder pump can also be installed in the tank, able to break up any foreign bodies in the waste water and project them at long distances.

**The FEKAFOS is designed for use with two (double models) non-automatic singlephase or three-phase pumps without float switch, which must be ordered separately together with the control panel.**

## COMPONENTS INCLUDED

- 2A lifting devices DSD2" and anti-rotation bracket for FEKA VS
- 6 Cable glands for double pump and floats
- 2 Floating cable clamp kits FEKA VS
- 3 floating and floating alarm support

**Materials** LLDPE

## Operating range

from 1 to 36 m<sup>3</sup>/h with a head of up to 25 mt.

**Maximum liquid temperature range** + 45°C

**Pumped liquid** ground water, rain water, clear waste water, black waste water and water from rivers and lakes.

**Installation** Inside or outside the building. Laid on the floor, under the ground or housed. Liquids compatible with EN12050-1/2

SELECTION  
TABLE  
PAG. 236

MODEL	CODE	CAPACITY [lt]	DIMENSION mm	TO BE USED WITH	DN PIPES [mm]	WEIGHT Kg.
FEKAFOS 280 2" DOUBLE	60163426	280	750x600x940	FEKA VS 550-750-1000-1200 M-NA/T-NA, GRINDER FX MNA/TNA, DRENAG FX MNA/TNA, FEKA FXV 20 MNA/TNA, FEKA FXC 20 MNA/TNA	DN 50/110 inlet DN 50 ventilation G2" outlet	53,7

# FEKAFOS 550 DOUBLE

AUTOMATIC PUMPING STATION



Automatic collection and lifting stations, used for the collection and pumping of civil and industrial waste water into the sewer network. They consist of a high density 550 litre polyethylene tank with 2 covers that can be walked on (maximum weight 100 kg), fitted with hermetic seals that prevent gases and liquids from escaping. Supplied with 2 lifting devices (DSD2), to facilitate pump maintenance. The FEKABOX range is ready for the use of one or two single-phase non-automatic pumps, or three-phase without float, which must be ordered separately, in conjunction with the control panel.

## COMPONENTS INCLUDED

- 2 DSD2" lifting devices and rotation prevention bracket for FEKA VS
- 6 cable glands for double pump and floats
- 2 FEKA VS float cable stop kits
- 3 floats and alarm float support

## Material LLDPE

### Operating range

from 1 to 32 m<sup>3</sup>/h with head up to 23 m.

**Liquid temperature range** + 45°C.

**Pumped liquid** ground water, rain water, clear waste water, grey waste water, and river or lake water. Liquids compatible with EN12050 1/2.

**Installation** Secured to the floor if inside a building. Underground if outside the building.

It cannot be driven on, but it can be walked on, maximum weight 100 kg.

SELECTION  
TABLE  
PAG. 236

MODEL	CODE	CAPACITY [lt]	DIMENSION mm	TO BE USED WITH	DN PIPES [mm]	WEIGHT Kg.
FEKAFOS 550 DOUBLE	60166306	550	770x1200x945	FEKA VS 550-750-1000-1200 M-NA/T, GRINDER FX MNA/TNA, DRENAG FX MNA/TNA, FEKA FXV 20 MNA/TNA, FEKA FXC 20 MNA/TNA	2xDN110 inlet 1xDN50 ventilation	94

# FEKAFOS MAXI 1200-3600

FK PUMP AUTOMATIC LIFTING STATION



Automatic collection and lifting station suitable for lifting clear and rain water, as well as water loaded with civil and industrial waste. It consists of a cylindrical polyethylene monobloc, and an appropriately shaped bottom for the housing of the pump and for avoiding water stagnation. The upper rectangular opening has polyethylene covers with locking system and smell prevention seals.

**1200 l to 3600 l capacity tanks available.**

**The tank may also be supplied with operation chamber with two gate valves and two non-return valves.**

**The station is ready for the use of two sewage water pumps, or non-automatic single-phase draining pumps, or three-phase pumps with delivery diameter from DN50 to DN80.**

**The pumps must be ordered separately in combination with the control panel.**

## Operating range

from 2 to 100m<sup>3</sup>/h with head up to 40m

**Pumped liquid temperature range** +50°C

## Pumped liquid

Rain water, ground water, waste water.

**Including** coupling feet for the housing of 2 pumps, inlet and outlet piping, bleeding systems, cable glands, floats, stainless steel sheets, anti-intrusion grid and cover with closing device.

## AVAILABLE ON REQUEST:

**GR:** with anti intrusion grid and inlet piping filtering grid.

**CV:** with cast iron check and gate valves.

**CV + GR:** with connection chamber for valves and filtering and anti intrusion grid.

STANDARD VERSION		GR VERSION	CAPACITY lt	NET CAPACITY lt	TO BE USED WITH	DIMENSIONS mm	DN PIPES mm	WEIGHT ** KG
MODEL	CODE	CODE						
FEKAFOS 1200 MAXI - DN50	60185601	60190475	1200	800	FEKA VS GRINDER FX MNA/TNA DRENAG FX MNA/TNA FEKA FXV 20 MNA/TNA FEKA FXC 20 MNA/TNA	1250 x 1250 x 1420	1x DN125 inlet 2x DN50 outlet 1x DN50 ventilation	140
FEKAFOS 1700 MAXI - DN50	60185602	60190476	1700	1050		1250 x 1250 x 1870		165
FEKAFOS 2200 MAXI - DN50	60185603	60190477	2200	1900		1250 x 1250 x 2320		190
FEKAFOS 3600 MAXI - DN50	60185604	60190478	3600	3100		1250 x 1250 x 3670		285
FEKAFOS 1200 MAXI - DN65	60184840	60190479	1200	800	FK DN65 FEKA FXV 25 MNA/TNA FAKA FXC 25 MNA/TNA	1250 x 1250 x 1420	1x DN160 inlet 2x DN65 outlet 1x DN50 ventilation	170
FEKAFOS 1700 MAXI - DN65	60185605	60190480	1700	1050		1250 x 1250 x 1870		195
FEKAFOS 2200 MAXI - DN65	60184841	60190481	2200	1900		1250 x 1250 x 2320		220
FEKAFOS 3600 MAXI - DN65	60184842	60190482	3600	3100		1250 x 1250 x 3670		315
FEKAFOS 1200 MAXI - DN80	60184843	60190483	1200	800	FK DN80	1250 x 1250 x 1420	1x DN160 inlet 2x DN80 outlet 1x DN50 ventilation	183
FEKAFOS 1700 MAXI - DN80	60185606	60190484	1700	1050		1250 x 1250 x 1870		208
FEKAFOS 2200 MAXI - DN80	60184844	60190485	2200	1900		1250 x 1250 x 2320		233
FEKAFOS 3600 MAXI - DN80	60184845	60190486	3600	3100		1250 x 1250 x 3670		328

CV VERSION		CV + GR VERSION	CAPACITY lt	NET CAPACITY lt	TO BE USED WITH	DIMENSIONS mm	DN PIPES mm	WEIGHT ** KG
MODEL	CODE	CODE						
FEKAFOS 1200 MAXI - DN50	60190464	60190415	1200	800	FEKA VS GRINDER FX MNA/TNA DRENAG FX MNA/TNA FEKA FXV 20 MNA/TNA FEKA FXC 20 MNA/TNA	1250 x 1500 x 1420	1x DN125 inlet 2x DN50 outlet 1x DN50 ventilation	215
FEKAFOS 1700 MAXI - DN50	60190465	60190451	1700	1050		1250 x 1500 x 1870		240
FEKAFOS 2200 MAXI - DN50	60190466	60190452	2200	1900		1250 x 1500 x 2320		265
FEKAFOS 3600 MAXI - DN50	60190413	60190453	3600	3100		1250 x 1500 x 3670		360
FEKAFOS 1200 MAXI - DN65	60190468	60190454	1200	800	FK DN65 FEKA FXV 25 MNA/TNA FAKA FXC 25 MNA/TNA	1250 x 1500 x 1420	1x DN160 inlet 2x DN65 outlet 1x DN50 ventilation	265
FEKAFOS 1700 MAXI - DN65	60190469	60190455	1700	1050		1250 x 1500 x 1870		290
FEKAFOS 2200 MAXI - DN65	60190470	60190456	2200	1900		1250 x 1500 x 2320		315
FEKAFOS 3600 MAXI - DN65	60190471	60190457	3600	3100		1250 x 1500 x 3670		410
FEKAFOS 1200 MAXI - DN80	60190472	60190458	1200	800	FK DN80	1250 x 1500 x 1420	1x DN160 inlet 2x DN80 outlet 1x DN50 ventilation	298
FEKAFOS 1700 MAXI - DN80	60190473	60190460	1700	1050		1250 x 1500 x 1870		323
FEKAFOS 2200 MAXI - DN80	60190474	60190461	2200	1900		1250 x 1500 x 2320		348
FEKAFOS 3600 MAXI - DN80	60190414	60190462	3600	3100		1250 x 1500 x 3670		443

\*\* Grid version add 15 Kg

## ACCESSORIES

	MODEL	CODE	SUPPLY
	CARRAIGE COVER FRAME D400 1200X1200	60190463	To be installed in external in a reinforced concrete structure appropriately created at street level. - Steel frame for anchoring on reinforced concrete slab - Cast-iron manhole cover D400 1200x1200 - Elevation and protection extension

# SELECTION TABLES

## STATION, PUMP AND CONTROL PANELS

STATION MODEL	CODE	PUMP MODEL	CODE
FEKABOX 110	60164870	FEKA 600 M A 40th	60190343
		FEKA VS 550 M-A	103040000
		FEKA VS 750 M-A	103040040
FEKABOX 200	60162080	FEKA 600 M A 40th	60190343
		FEKA VS 550 M-A	103040000
		FEKA VS 750 M-A	103040040
		FEKA VS 1000 M-A	103040080
		FEKA VS 1200 M-A	103040120
FEKABOX 200 FX	60198414	FEKA FXV 20.07 MA	60191210
		FEKA FXV 20.11 MA	60191229
		FEKA FXV 20.15 MA	60194185
		FEKA FXC 20.07 MA	60191213
		FEKA FXC 20.11 MA	60191233
		FEKA FXC 20.15 MA	60191251
		DRENAG FX 15.07 MA	60191219
		DRENAG FX 15.11 MA	60191239
		DRENAG FX 15.15 MA	60191257
		GRINDER FX 15.07 MA	60191222
		GRINDER FX 15.11 MA	60191242
		GRINDER FX 15.15 MA	60191260



FEKABOX 110



FEKABOX 200

Tank and pump are supplied separately and must be ordered separately.

STATION MODEL	CODE	PUMP MODEL	CODE	CONTROL PANEL MODEL	CODE	CONTROL PANEL MODEL	CODE
FEKAFOS 280	60162044	FEKA VS 550 M-NA	103040010	ED1M	60170005	EBOX PLUS D	60163217
		FEKA VS 550 T-NA	103040020	ED1T	108320330		
		FEKA VS 750 M-NA	103040050	ED1M	60170005		
		FEKA VS 750 T-NA	103040060	ED1T	108320330		
		FEKA VS 1000 M-NA	103040090	ED1,5M	60170006		
		FEKA VS 1000 T-NA	103040100	ED1,5T	108320340		
		FEKA VS 1200 M-NA	103040130	ED1,5M	60170006		
		FEKA VS 1200 T-NA	103040140	ED1,5T	108320340		
		FEKA FXV 20.07 MNA	60191208	ED1,5M	60170006		
		FEKA FXV 20.07 TNA	60191209	ED1,5T	108320340		
		FEKA FXV 20.11 MNA	60191227	ED1,5M	60170006		
		FEKA FXV 20.11 TNA	60191228	ED1,5T	108320340		
		FEKA FXV 20.15 MNA	60194186	ED2M	108320350		
		FEKA FXV 20.15 TNA	60191261	ED2,5T	108320350		
		FEKA FXV 20.22 TNA	60191265	ED2,5T	108320350		
		FEKA FXC 20.07 MNA	60191211	ED1M	60170005		
		FEKA FXC 20.07 TNA	60191212	ED1T	108320330		
		FEKA FXC 20.11 MNA	60191231	ED1,5M	60170006		
		FEKA FXC 20.11 TNA	60191232	ED1,5T	108320340		
		FEKA FXC 20.15 MNA	60191249	ED1,5M	60170006		
		FEKA FXC 20.15 TNA	60191250	ED1,5T	108320340		
		FEKA FXC 20.22 TNA	60191273	ED2,5T	108320350		
		DRENAG FX 15.07 MNA	60191217	ED1,5M	60170006		
		DRENAG FX 15.07 TNA	60191218	ED1T	108320330		
		DRENAG FX 15.11 MNA	60191237	ED1,5M	60170006		
		DRENAG FX 15.11 TNA	60191238	ED1,5T	108320340		
		DRENAG FX 15.15 MNA	60191255	ED2M	108320350		
		DRENAG FX 15.15 TNA	60191256	ED2,5T	108320350		
		DRENAG FX 15.22 TNA	60191277	ED2,5T	108320350		
		GRINDER FX 15.07 MNA	60191220	ED1M	60170005		
		GRINDER FX 15.07 TNA	60191221	ED1T	108320330		
		GRINDER FX 15.11 MNA	60191240	ED1,5M	60170006		
		GRINDER FX 15.11 TNA	60191278	ED1,5T	108320340		
		GRINDER FX 15.15 MNA	60191258	ED2M	108320350		
		GRINDER FX 15.15 TNA	60191259	ED1,5T	108320340		
		GRINDER FX 15.22 TNA	60191279	ED2,5T	108320350		



FEKAFOS 280

Tank, pump and control panel are supplied separately and must be ordered separately.

# SELECTION TABLES

## STATION, PUMP AND CONTROL PANELS

STATION MODEL	CODE	PUMP MODEL	CODE	CONTROL PANEL MODEL	CODE	CONTROL PANEL MODEL	CODE
<b>FEKAFOS 280 DOUBLE</b>	60163426	<b>FEKA VS 550 M-NA</b>	103040010	<b>E2D2M</b>	60170021	<b>EBOX PLUS D</b>	60163217
		<b>FEKA VS 550 T-NA</b>	103040020	<b>E2D2T</b>	108320440		
		<b>FEKA VS 750 M-NA</b>	103040050	<b>E2D2M</b>	60170021		
		<b>FEKA VS 750 T-NA</b>	103040060	<b>E2D2T</b>	108320440		
		<b>FEKA VS 1000 M-NA</b>	103040090	<b>E2D3M</b>	60170025		
		<b>FEKA VS 1000 T-NA</b>	103040100	<b>E2D3T</b>	108320450		
		<b>FEKA VS 1200 M-NA</b>	103040130	<b>E2D3M</b>	60170025		
		<b>FEKA VS 1200 T-NA</b>	103040140	<b>E2D3T</b>	108320450		
		<b>FEKA FXV 20.07 MNA</b>	60191208	<b>E2D3M</b>	60170025		
		<b>FEKA FXV 20.07 TNA</b>	60191209	<b>E2D2T</b>	108320440		
		<b>FEKA FXV 20.11 MNA</b>	60191227	<b>E2D3M</b>	60170025		
		<b>FEKA FXV 20.11 TNA</b>	60191228	<b>E2D3T</b>	108320450		
		<b>FEKA FXV 20.15 MNA</b>	60194186	<b>E2D4M</b>	108320460		
		<b>FEKA FXV 20.15 TNA</b>	60191261	<b>E2D3T</b>	108320450		
		<b>FEKA FXV 20.22 TNA</b>	60191265	<b>E2D5T</b>	108320460		
		<b>FEKA FXC 20.07 MNA</b>	60191211	<b>E2D2M</b>	60170021		
		<b>FEKA FXC 20.07 TNA</b>	60191212	<b>E2D2T</b>	108320440		
		<b>FEKA FXC 20.11 MNA</b>	60191231	<b>E2D3M</b>	60170025		
		<b>FEKA FXC 20.11 TNA</b>	60191232	<b>E2D3T</b>	108320450		
		<b>FEKA FXC 20.15 MNA</b>	60191249	<b>E2D3M</b>	60170025		
		<b>FEKA FXC 20.15 TNA</b>	60191250	<b>E2D3T</b>	108320450		
		<b>FEKA FXC 20.22 TNA</b>	60191273	<b>E2D5T</b>	108320460		
		<b>DRENAG FX 15.07 MNA</b>	60191217	<b>E2D2M</b>	60170021		
		<b>DRENAG FX 15.07 TNA</b>	60191218	<b>E2D2T</b>	108320440		
		<b>DRENAG FX 15.11 MNA</b>	60191237	<b>E2D3M</b>	60170025		
		<b>DRENAG FX 15.11 TNA</b>	60191238	<b>E2D3T</b>	108320450		
		<b>DRENAG FX 15.15 MNA</b>	60191255	<b>E2D4M</b>	108320460		
		<b>DRENAG FX 15.15 TNA</b>	60191256	<b>E2D5T</b>	108320460		
		<b>DRENAG FX 15.22 TNA</b>	60191277	<b>E2D5T</b>	108320460		
		<b>GRINDER FX 15.07 MNA</b>	60191220	<b>E2D3M</b>	60170025		
		<b>GRINDER FX 15.07 TNA</b>	60191221	<b>E2D3T</b>	108320450		
		<b>GRINDER FX 15.11 MNA</b>	60191240	<b>E2D3M</b>	60170025		
<b>GRINDER FX 15.11 TNA</b>	60191278	<b>E2D3T</b>	108320450				
<b>GRINDER FX 15.15 MNA</b>	60191258	<b>E2D4M</b>	108320460				
<b>GRINDER FX 15.15 TNA</b>	60191259	<b>E2D5T</b>	108320460				
<b>GRINDER FX 15.22 TNA</b>	60191279	<b>E2D5T</b>	108320460				



**FEKAFOS 280  
DOUBLE**

Tank, pump and control panel are supplied separately and must be ordered separately.

When selecting a control panel other than EBOX PLUS D, refer to the pump & control panel selection table in the EBOX section on pag. 249

# SELECTION TABLES

## STATION, PUMP AND CONTROL PANELS

STATION MODEL	CODE	PUMP MODEL	CODE	CONTROL PANEL MODEL	CODE	CONTROL PANEL MODEL	CODE
FEKAFOS 550 DOUBLE	60166306	FEKA VS 550 M-NA	103040010	E2D2M	60170021	EBOX PLUS D	60163217
		FEKA VS 550 T-NA	103040020	E2D2T	108320440		
		FEKA VS 750 M-NA	103040050	E2D2M	60170021		
		FEKA VS 750 T-NA	103040060	E2D2T	108320440		
		FEKA VS 1000 M-NA	103040090	E2D3M	60170025		
		FEKA VS 1000 T-NA	103040100	E2D3T	108320450		
		FEKA VS 1200 M-NA	103040130	E2D3M	60170025		
		FEKA VS 1200 T-NA	103040140	E2D3T	108320450		
		FEKA FXV 20.07 MNA	60191208	E2D3M	60170025		
		FEKA FXV 20.07 TNA	60191209	E2D2T	108320440		
		FEKA FXV 20.11 MNA	60191227	E2D3M	60170025		
		FEKA FXV 20.11 TNA	60191228	E2D3T	108320450		
		FEKA FXV 20.15 MNA	60194186	E2D4M	108320460		
		FEKA FXV 20.15 TNA	60191261	E2D3T	108320450		
		FEKA FXV 20.22 TNA	60191265	E2D5T	108320460		
		FEKA FXC 20.07 MNA	60191211	E2D2M	60170021		
		FEKA FXC 20.07 TNA	60191212	E2D2T	108320440		
		FEKA FXC 20.11 MNA	60191231	E2D3M	60170025		
		FEKA FXC 20.11 TNA	60191232	E2D3T	108320450		
		FEKA FXC 20.15 MNA	60191249	E2D3M	60170025		
		FEKA FXC 20.15 TNA	60191250	E2D3T	108320450		
		FEKA FXC 20.22 TNA	60191273	E2D5T	108320460		
		DRENAG FX 15.07 MNA	60191217	E2D2M	60170021		
		DRENAG FX 15.07 TNA	60191218	E2D2T	108320440		
		DRENAG FX 15.11 MNA	60191237	E2D3M	60170025		
		DRENAG FX 15.11 TNA	60191238	E2D3T	108320450		
		DRENAG FX 15.15 MNA	60191255	E2D4M	108320460		
		DRENAG FX 15.15 TNA	60191256	E2D5T	108320460		
		DRENAG FX 15.22 TNA	60191277	E2D5T	108320460		
		GRINDER FX 15.07 MNA	60191220	E2D3M	60170025		
		GRINDER FX 15.07 TNA	60191221	E2D3T	108320450		
		GRINDER FX 15.11 MNA	60191240	E2D3M	60170025		
		GRINDER FX 15.11 TNA	60191278	E2D3T	108320450		
GRINDER FX 15.15 MNA	60191258	E2D4M	108320460				
GRINDER FX 15.15 TNA	60191259	E2D5T	108320460				
GRINDER FX 15.22 TNA	60191279	E2D5T	108320460				



FEKAFOS 550 DOUBLE

Tank, pump and control panel are supplied separately and must be ordered separately.

When selecting a control panel other than EBOX PLUS D, refer to the pump & control panel selection table in the EBOX section on pag. 249



# SELECTION TABLES

## STATION, PUMP AND CONTROL PANELS



FEKAFOS MAXI

STATION MODEL	CODE	PUMP MODEL	CODE	CONTROL PANEL MODEL	CODE	CONTROL PANEL MODEL	CODE
FEKAFOS MAXI 1200 - DN50 FEKAFOS MAXI 1700 - DN50 FEKAFOS MAXI 2200 - DN50 FEKAFOS MAXI 3600 - DN50	60185601 60185602 60185603 60185604	FEKA VS 550 M-NA	103040010	E2D2M	60170021	EBOX PLUS D	60163217
		FEKA VS 550 T-NA	103040020	E2D2T	108320440		
		FEKA VS 750 M-NA	103040050	E2D2M	60170021		
		FEKA VS 750 T-NA	103040060	E2D2T	108320440		
		FEKA VS 1000 M-NA	103040090	E2D3M	60170025		
		FEKA VS 1000 T-NA	103040100	E2D3T	108320450		
		FEKA VS 1200 M-NA	103040130	E2D3M	60170025		
		FEKA VS 1200 T-NA	103040140	E2D3T	108320450		
		FEKA FXV 20.07 MNA	60191208	E2D3M	60170025		
		FEKA FXV 20.07 TNA	60191209	E2D2T	108320440		
		FEKA FXV 20.11 MNA	60191227	E2D3M	60170025		
		FEKA FXV 20.11 TNA	60191228	E2D3T	108320450		
		FEKA FXV 20.15 MNA	60194186	E2D4M	108320460		
		FEKA FXV 20.15 TNA	60191261	E2D3T	108320450		
		FEKA FXV 20.22 TNA	60191265	E2D5T	108320460		
		FEKA FXC 20.07 MNA	60191211	E2D2M	60170021		
		FEKA FXC 20.07 TNA	60191212	E2D2T	108320440		
		FEKA FXC 20.11 MNA	60191231	E2D3M	60170025		
		FEKA FXC 20.11 TNA	60191232	E2D3T	108320450		
		FEKA FXC 20.15 MNA	60191249	E2D4M	108320460		
		FEKA FXC 20.15 TNA	60191250	E2D3T	108320450		
		FEKA FXC 20.22 TNA	60191273	E2D5T	108320460		
		DRENAG FX 15.07 MNA	60191217	E2D2M	60170021		
		DRENAG FX 15.07 TNA	60191218	E2D2T	108320440		
		DRENAG FX 15.11 MNA	60191237	E2D3M	60170025		
		DRENAG FX 15.11 TNA	60191238	E2D3T	108320450		
		DRENAG FX 15.15 MNA	60191255	E2D4M	108320460		
		DRENAG FX 15.15 TNA	60191256	E2D5T	108320460		
		DRENAG FX 15.22 TNA	60191277	E2D5T	108320460		
		GRINDER FX 15.07 MNA	60191220	E2D3M	60170025		
		GRINDER FX 15.07 TNA	60191221	E2D3T	108320450		
		GRINDER FX 15.11 MNA	60191240	E2D3M	60170025		
GRINDER FX 15.11 TNA	60191278	E2D3T	108320450				
GRINDER FX 15.15 MNA	60191258	E2D4M	108320460				
GRINDER FX 15.15 TNA	60191259	E2D5T	108320460				
GRINDER FX 15.22 TNA	60191279	E2D5T	108320460				

Tank, pump and control panel are supplied separately and must be ordered separately.

When selecting a control panel other than EBOX PLUS D, refer to the pump & control panel selection table in the EBOX section on pag. 249

# SELECTION TABLES

## STATION, PUMP AND CONTROL PANELS



FEKAFOS MAXI

STATION MODEL	CODE	PUMP MODEL	CODE	CONTROL PANEL MODEL	CODE	CONTROL PANEL MODEL	CODE		
FEKAFOS 1200 MAXI - DN65 FEKAFOS 1700 MAXI - DN65 FEKAFOS 2200 MAXI - DN65 FEKAFOS 3600 MAXI - DN65	60184840	FEKA FXV 25.07.4 TNA	60191269	E2D3M	60170025	EBOX PLUS D	60163217		
		FEKA FXV 25.12.4 TNA	60191271	E2D3T	108320450				
		FEKA FXV 25.07 MNA	60196349	E2D3M	60170025				
		FEKA FXV 25.07 TNA	60196351	E2D3T	108320450				
		FEKA FXV 25.11 MNA	60191230	E2D4M	108320460				
		FEKA FXV 25.11 TNA	60191244	E2D5T	108320460				
		FEKA FXV 25.15 MNA	60194201	E2D5T	108320460				
		FEKA FXV 25.15 TNA	60191263	E2D3T	108320450				
		FEKA FXV 25.22 TNA	60191267	E2D3T	108320450				
		FEKA FXC 25.07 MNA	60191214	E2D3M	60170025				
		FEKA FXC 25.07 TNA	60191215	E2D3T	108320450				
		FEKA FXC 25.11 MNA	60191234	E2D4M	108320460				
		FEKA FXC 25.11 TNA	60191235	E2D5T	108320460				
		FEKA FXC 25.15 MNA	60191252	E2D5T	108320460				
		FEKA FXC 25.15 TNA	60191253	E2D3T	108320450				
		FEKA FXC 25.22 TNA	60191275	E2D3T	108320450				
		FKV 65.11.4 T5 400D	60172586	E2D3T	108320450				
		FKV 65.22.2 T5 400D	60171422	E2D5T	108320460				
FKV 65.30.2 T5 400D	60170389	E2D5T	108320460						
FKV 65.40.2 T5 400D	60171423	E2D8T	60170062						
FKC 65.22.2 T5 400D	60176795	E2D5T	108320460						
FKC 65.30.2 T5 400D	60176857	E2D5T	108320460						
FEKAFOS 1200 MAXI - DN80 FEKAFOS 1700 MAXI - DN80 FEKAFOS 2200 MAXI - DN80 FEKAFOS 3600 MAXI - DN80	60184843	FKV 80.11.4 T5 400D	60171443	E2D3T	108320450	EBOX PLUS D	60163217		
		FKV 80.15.4 T5 400D	60171444	E2D3T	108320450				
		FKV 80.22.4 T5 400D	60170418	E2D5T	108320460				
		FKV 80.40.4 T5 400D	60171445	E2D8T	60170062				
	60185606	FKV 80.40.2 T5 400D	60171424	E2D8T	60170062				
		FKV 80.60.2 T5 400Y/D	60171425	E2D15T SD	60170047			-	-
	60184844	FKV 80.75.2 T5 400Y/D	60170434	E2D15T SD	60170047			-	-
		FKV 80.92.2 T5 400Y/D	60171426	E2D30T SD	60170065			-	-
	60184845	FKV 80.110.2 T5 400Y/D	60170429	E2D30T SD	60170065			-	-
		FKC 80.15.4 T5 400D	60176796	E2D3T	108320450				
		FKC 80.22.4 T5 400D	60176858	E2D5T	108320460				
		FKC 80.30.4 T5 400D	60176871	E2D8T	60170062				
FKC 80.40.4 T5 400D		60176872	E2D8T	60170062					
FKC 80.55.4 T5 400Y/D		60176854	E2D15T SD	60170047	-	-			
FKC 80.75.4 T5 400Y/D	60176855	E2D30T SD	60170065	-	-				

Tank, pump and control panel are supplied separately and must be ordered separately.

When selecting a control panel other than EBOX PLUS D, refer to the pump & control panel selection table in the EBOX section on pag. 249

# NOVAIR

## SUBMERGED AERATOR



The submerged aerator is designed for liquid waste aeration in small water treatment systems. Other fields of application include pond water oxygenation and fish farms. Thanks to its specific design, the new **NOVAIR** system guarantees optimal oxygenation of water treatment plants by means of a large and thick cloud of fine bubbles. The fluid dynamics study has been mainly focused on the impeller's blade profiles, with a view to avoid damaging microorganisms present in the water when starting operation. As the aerator is installed vertically, its body is supplied with a supporting base.

Technically speaking, motor cooling is guaranteed by large contact surfaces between motor casing and the liquid. The power cable is coated with resin against humidity and leaks and cabling has been made easier, in order to favour maintenance operations and cable replacement. The excellent wear resistance of the stainless steel motor shaft, with ceramic bush around the sealing rings, guarantees long product durability. Pump body, cable cover and impeller in technopolymer. Two-pole asynchronous submersible type motor from 0.18 and 0.4 kW with built-in THERMAL PROTECTION and permanently connected capacitor installed in the cable compartment. Steel motor shaft mounted on oversized, greased sealed-for-life ball bearings with ceramic bush. Triple interposed ring seal with oil pre-chamber.

**Operating range** air delivery 2 - 17 m<sup>3</sup>/h for depths from 20 – 90 cm, from the inlet axis.

**Protection level** IP68

**Insulating class** F

**Liquid temperature range** from 0 °C to 35 °C according to EN 60335-2-41 standard for domestic use

**Liquid quality requirements** sewage from septic tank fibre-less and free from solids, and clear water.

**Single-phase** monophase: 220 – 240 V/ 50 Hz

**Power cable** H07RNF8-F of 2 mt, 5mt e 10 mt and SCHUKO plug available. Supplied with gasket and 90 degrees band for vertical inlet.

MODEL	CODE	ELECTRICAL DATA					HYDRAULIC DATA														AIR DELIVERY MAX m <sup>3</sup> /h	DEPTH		DNM GAS	CABLE	WEIGHT Kg	Q.TY x PALLET
		VOLTAGE 50 Hz	P1 MAX kW	P2 NOMINAL		In A	Q AIR m <sup>3</sup> /h l/min	1	2	3	4	6	8	10	12	14	17,5	MAX cm	MIN cm								
				kW	HP			16,6	33,3	50	66,6	100	133,3	166,6	200	233,3	291,6										
<b>NOVAIR 200 M-NA</b>	60168124	1X220- 240 V~	0,28	0,18	0,24	1,4	Prof. (cm)	80	60	45	30	20						8	80	20	1"	2 mt / H07RNF8-F	3,5	32			
<b>NOVAIR 200 M-NA</b>	60169563	1X220- 240 V~	0,28	0,18	0,24	1,4		80	60	45	30	20						8	80	20	1"	5 mt / H07RNF8-F	3,5	32			
<b>NOVAIR 200 M-NA</b>	60172219	1X220- 240 V~	0,28	0,18	0,24	1,4		80	60	45	30	20						8	80	20	1"	10 mt / H07RNF8-F	3,5	32			
<b>NOVAIR 600 M-NA</b>	60171450	1X220- 240 V~	0,63	0,40	0,54	3		90	85	75	65	57	50	42,5	34	27	20	17,5	90	20	1 1/4"	2 mt / H07RNF8-F	5,4	32			
<b>NOVAIR 600 M-NA</b>	60170247	1X220- 240 V~	0,63	0,40	0,54	3		90	85	75	65	57	50	42,5	34	27	20	17,5	90	20	1 1/4"	5 mt / H07RNF8-F	5,4	32			
<b>NOVAIR 600 M-NA</b>	60170078	1X220- 240 V~	0,63	0,40	0,54	3		90	85	75	65	57	50	42,5	34	27	20	17,5	90	20	1 1/4"	10 mt / H07RNF8-F	5,4	32			



# PUMPING STATIONS ACCESSORIES PROTECTION AND CONTROL PANELS

---

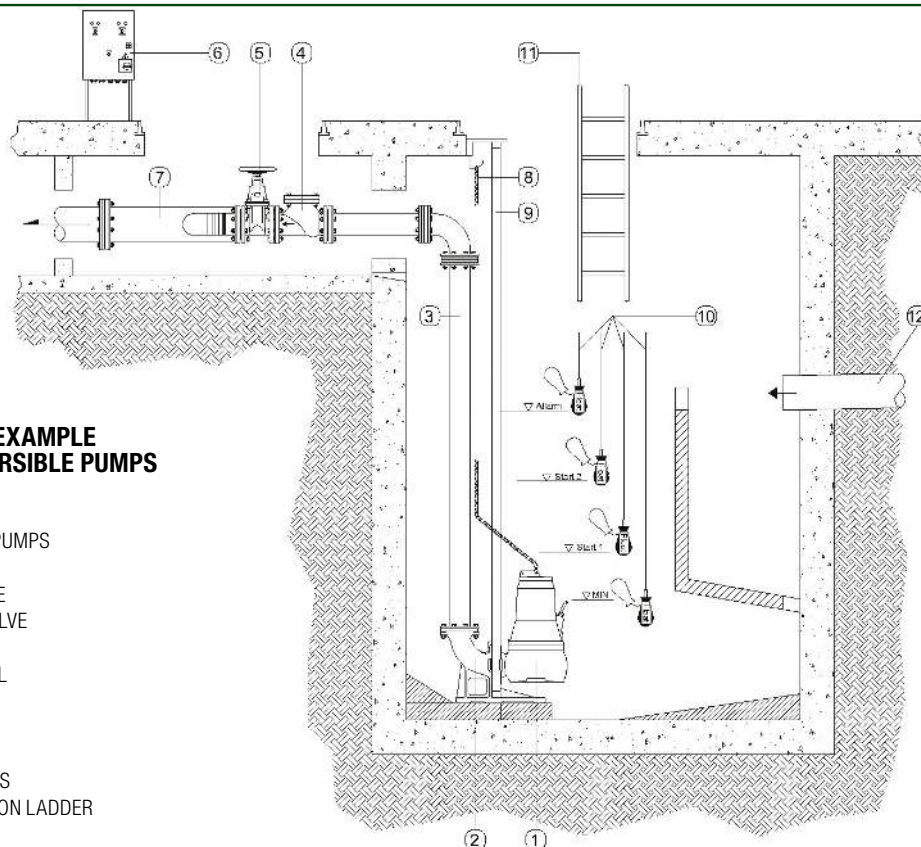



## INSTALLATION EXAMPLE OF TWO SUBMERSIBLE PUMPS

### KEY:



- 1 SUBMERSIBLE PUMPS
- 2 BASE ELBOW
- 3 DISCHARGE PIPE
- 4 BALL CHECK VALVE
- 5 GATE VALVE
- 6 CONTROL PANEL
- 7 MANIFOLD
- 8 LIFTING CHAIN
- 9 DROP PIPE
- 10 LEVEL SWITCHES
- 11 SUMP INSPECTION LADDER
- 12 INTAKE PIPE

FLOATS	NOVA/FEKA DRENAG	FEKA VS	FX	FK	SOCCORRER	FEKABOX / FEKAFOS	DESCRIPTION	CODE	
	●	●	●	●	●		FLOAT KEY	5 METERS	159260030
								10 METERS	159260040
								15 METERS	159260050
								20 METERS	159260070
		●	●	●		●	FLOAT ATEX	10 METERS	60119025
								20 METERS	002718000
	●	●	●	●	●		FLOAT SWICH COUNTERWEIGHT - 300 GR		002910501
		●				●	FLOAT CABLE STOP KIT FOR FEKA VS		147121370

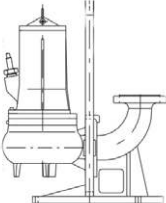
# PUMPING STATIONS ACCESSORIES

LIFTING DEVICES	NOVA/FEKA DRENAG	FEKA VS	FX	FEKA 6000/8000	FEKABOX / FEKAFOS	DESCRIPTION	CODE
		●				DSD2- LIFTING DEVICE FOR FEKA VS 550-1200	109530080
		●				ANTIROTATION BRACKET FOR FEKA VS	147121490
				●		LIFTING UNIT FOR FEKA 6000 DN 150	109530150
				●		LIFTING UNIT FOR FEKA 8000 DN 200	60141748





GUIDE TUBES NOT INCLUDED

COUPLING UNIT	NOVA/FEKA DRENAG	FEKA VS	FX	FK	FEKABOX / FEKAFOS	DESCRIPTION	CODE
			●			DA-050 HORIZONTAL COUPLING UNIT DN32 DN40 DN50	60195865
			●	●		DA-065 HORIZONTAL COUPLING UNIT DN65	60170310
				●		DA-V65 COUPLING UNIT DN65	60167993
				●		DA-V80 COUPLING UNIT DN80	60167994
				●		DA-V100 COUPLING UNIT DN100	60169609
				●		DA-V150 COUPLING UNIT DN150	60169610

RINGSTAND	NOVA/FEKA DRENAG	FEKA VS	FX	FK	FEKABOX / FEKAFOS	DESCRIPTION	CODE
				●		RINGSTAND Ø325 FK	60170329
				●		RINGSTAND Ø330 FK	60170330
				●		RINGSTAND Ø355 FK	60170331
				●		RINGSTAND Ø400 FK	60184584

# PUMPING STATIONS ACCESSORIES



SHACKLE KITS	NOVA/FEKA DRENAG	FEKA VS	FX	FK	FEKABOX / FEKAFOS	DESCRIPTION	CODE
	●	●	●	●	●	KIT CHAIN W/SHACKLE 3MT A316 MAX 150KG	60171183
						KIT CHAIN W/SHACKLE 3MT A316 MAX 350KG	60178908
						KIT CHAIN W/SHACKLE 3MT A316 MAX 700KG	60171189

ADAPTERS	NOVA/FEKA DRENAG	FEKA VS	FX	FK	FEKABOX / FEKAFOS	DESCRIPTION	CODE
				●		FLYGT COUPLING ADAPTER DN65	60169712
				●		FLYGT COUPLING ADAPTER DN80	60169713
				●		FLYGT COUPLING ADAPTER DN100	60169715
				●		FLYGT COUPLING ADAPTER DN150	60169717
				●		COUPLING SYSTEM ADAPTOR FK65 FEKA 2500	60172547
				●		COUPLING SYSTEM ADAPTOR FK80 FEKA 3000	60171768
				●		COUPLING SYSTEM ADAPTOR FK100 FEKA 4000	60171770
				●		COUPLING SYSTEM ADAPTOR FK150 FEKA 6000	60171772
				●		COUPLING SYSTEM ADAPTOR FK 65 FEKA 3000	60171774
				●		COUPLING SYSTEM ADAPTOR FK80 FEKA 4000	60171776
				●		COUPLING SYSTEM ADAPTOR FX GRINDER – FEKA DN32 DN40 DN50	60196199
				●		COUPLING SYSTEM ADAPTOR FX - FLYGT DN50	60196203
				●		KIT ELBOW 90° 2" GAS FX	60195856
				●		KIT ELBOW 90° 1"1/2 GAS FX	60195857

KIT FLANGE	NOVA/FEKA DRENAG	FEKA VS	FX	FK	FEKABOX / FEKAFOS	DESCRIPTION	CODE
			●	●		KIT FLANGE DN 65 PN16 UNI 2254	60172458
				●		KIT FLANGE DN 80 PN16 UNI 2254	60172460
				●		KIT FLANGE DN100 PN16 UNI 2254	60172461





# PUMPING STATIONS ACCESSORIES

BALL NON-RETURN VALVES	NOVA/FEKA DRENAG	FEKA VS	FX	FK	FEKABOX / FEKAFOS	DESCRIPTION	CODE
	•					PVC NON-RETURN VALVE (BALL) PN10 1" ¼ - THREADED	002130285
	•	•	•			PVC NON-RETURN VALVE (BALL) PN10 1" ½ - THREADED	002130286
	•	•	•		•	PVC NON-RETURN VALVE (BALL) PN10 2" - THREADED	002130287
	•	•	•	•	•	PVC NON-RETURN VALVE (BALL) PN10 2" 1/2- THREADED	60171217
	•	•	•	•	•	PVC NON-RETURN VALVE (BALL) PN10 3" - THREADED	60171218
	•					PVC NON-RETURN VALVE (BALL) 1" ¼ - THREADED	60160625
	•	•	•			NON RETURN VALVE (BALL) 1" ½ - THREADED	60160626
	•	•	•		•	NON RETURN VALVE (BALL) 2" - THREADED	60160627
	•	•	•	•		NON RETURN VALVE (BALL) 2" ½ - THREADED	60160628
		•	•		•	DN50 NON RETURN VALVE (BALL)	60160629
		•	•	•	•	DN65 NON RETURN VALVE (BALL)	60160630
					•	DN 80 NON RETURN VALVE (BALL)	60160631
					•	DN100 NON RETURN VALVE (BALL)	60160632
					•	DN 150 NON RETURN VALVE (BALL)	60160633
						DN200 NON RETURN VALVE (BALL)	60160634

REFLOW KIT	NOVA/FEKA DRENAG	FEKA VS	FX	FK	FEKABOX / FEKAFOS	DESCRIPTION	CODE
	•	•	•		•	REFLOW KIT	538860000

GATE VALVES	NOVA/FEKA DRENAG	FEKA VS	FX	FK	FEKABOX / FEKAFOS	DESCRIPTION	CODE	
		•	•		•	GATE VALVE FLANGED DN 50	60163811	
		•	•	•	•	GATE VALVE FLANGED DN 65	60163812	
					•	•	GATE VALVE FLANGED DN 80	60163813
					•	•	GATE VALVE FLANGED DN 100	60163814
					•	•	GATE VALVE FLANGED DN 150	60163815
						•	GATE VALVE FLANGED DN 200	60163816

# PUMPING STATIONS ACCESSORIES

ALARMS AND CONTROL	NOVA/FEKA DRENAG	FEKA VS	FX	FK	FEKABOX / FEKAFOS	DESCRIPTION	CODE
	•	•	•			AS 1 CONTROL WITH ALARM DEVICE	108310000
	•	•	•	•	•	ACUSTIC ALARM - 230 V - 50HZ	002789002
						ACUSTIC ALARM - 24 V - 50 HZ	002789000
	•	•	•	•		FLASCHING 230V 5W 50/60 HZ	60169271

TRASDUCERS	NOVA/FEKA DRENAG	FEKA VS	FX	FK	FEKABOX / FEKAFOS	DESCRIPTION	CODE
	•	•	•	•		PRESSURE TRASDUCER 0-5 MT CABLE 20 MT. FOR EBOX	60114675

# EBOX

## ELECTRONIC PROTECTION AND CONTROL PANEL



Ebox plus D



Ebox basic

# ebox

**Ebox plus** is an electronic control panel for the protection and automatic operation of one or two submersible pumps or pressurizing both single-phase and three-phase, installed in domestic, civil and industrial environments.

**Ebox basic** is an electronic control panel for the protection and automatic operation of one or two electronic submersible pumps or single-phase pressurization for domestic applications.

### Nominal tension of power supply

**Ebox plus** 1x 230 V / 3 x 230 V - 3 x 400 V  
(automatic selection)

**Ebox basic** 1x 230 V

**Frequency** 50 - 60 Hz

### Maximum use of power

**Ebox plus** 5,5 kWatt + 5,5 kWatt

**Ebox basic** 2,2 kWatt + 2,2 kWatt

**Maximum use of current** 12 A + 12 A

**Starting capacitor** KIT supplied as an accessory

### Limits of use ambient temperature

-10° C + 40° C

**Limits of storage temperature** -25° C + 55° C

**Relative humidity to the air** 90% a 20° C

**Max altitude max** 1000 s.l.m.

**Degree of protection** IP 55

Reference standard for the construction of the panels EN 60335-1

## D+CONNECT

PAG. 5

ACCESSORIES  
PAG. 250

MODEL	CODE	VOLTAGE 50 HZ	STARTING	P2 NOMINAL		MAX CURRENT A	DISPLAY
				kW x2	HP x2		
<b>EBOX BASIC 230/50-60</b>	60163214	1 X 230 V	DIRECT	2,2	3	12+12	-
<b>EBOX PLUS 230-400V/50-60</b>	60163215	1 X 230 V	DIRECT	2,2	3	12+12	-
		3 X 230 V		3	4		
		3 X 400 V		5,5	7,5		
<b>EBOX BASIC D 230/50-60</b>	60163216	1 X 230 V	DIRECT	2,2	3	12+12	•
<b>EBOX PLUS D 230-400V/50-60</b>	60163217	1 X 230 V	DIRECT	2,2	3	12+12	•
		3 X 230 V		3	4		
		3 X 400 V		5,5	7,5		

## DISPLAY



Thanks to the configuration wizard, installation of display versions is much simpler. Management is also much easier, thanks to the status always being visible and to a range of additional functions, such as the anti-seizing of drainage pumps, the alarm log, the language selection, and the password protected settings.

# EBOX

ELECTRONIC PROTECTION AND CONTROL PANEL





## EMPTYING/FILLING FUNCTION

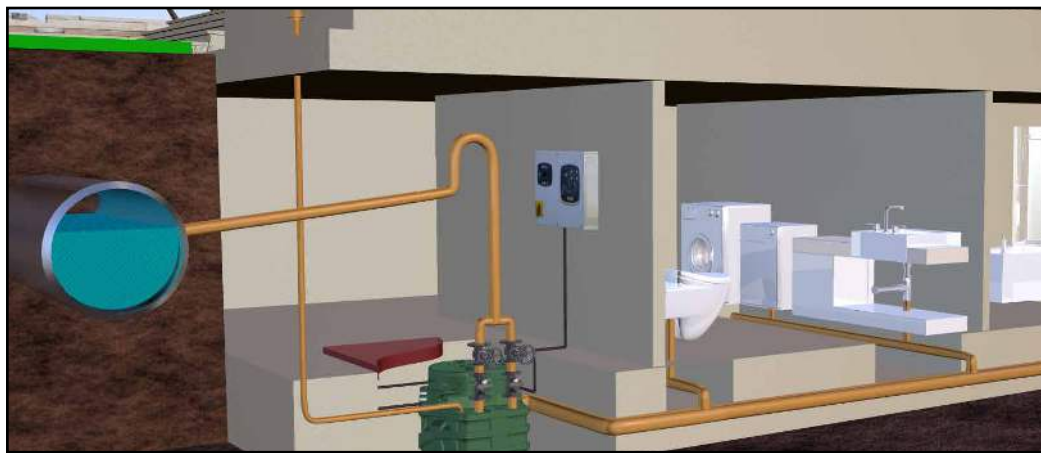

Ideal for piloting the pumping stations of filling / emptying the drainage of rainwater or waste water in general.

- Operation with bulb floats or standard, max 5 (2/3 for operation, 2 for alarm)
- Operation with level trasducer (0-10V / 4...20mA)
- Exchange of the starting order of the pumps at every start, every 24 hours or at predefined intervals.



## ACCESSORIES

DESCRIPTION		CODE	
	FLOAT KEY	5 METERS	159260030
		10 METERS	159260040
		15 METERS	159260050
		20 METERS	159260070
	BULB-FLOAT	10 METERS	002718000
		20 METERS	002718001
	PRESSURE TRASDUCER 0-5 MT- CABLE 20 MT. FOR EBOX	60114675	

DESCRIPTION		CODE
	KIT CAPACITOR 40UF	60169268
	KIT CAPACITOR 30UF	60169269
	KIT CAPACITOR 20UF	60169270
	FLASCHING 230V 5W 50/60 HZ EQUIPPED WITH A 5W INCANDESCENT BULB	60169271
	PRESS. TRAS. 16 BAR (FOR B. SETS WITH CONTR. PANEL EBOX )	60116837

# ELECTRONIC PROTECTION AND CONTROL PANELS

## SELECTION TABLE SERIE NOVA/DRENAG + PANELS

PUMP MODEL	CODE	VOLTAGE	P1 MAX	kW	HP	In A	START
NOVA 600 M NA 40TH	60195636	1X230V~	0,66	0,5	0,67	3	DIRECT
NOVA 600 T NA 40TH	60196306	3X400V~	0,66	0,5	0,67	1,7	DIRECT
DRENAG 1000 M-NA	103041010	1X230V~	1,29	1	1,36	6	DIRECT
DRENAG 1000 T-NA	103041020	3X400V~	1,18	1	1,36	2,43	DIRECT
DRENAG 1200 M-NA	103041050	1X230V~	1,85	1,2	1,6	7,5	DIRECT
DRENAG 1200 T-NA	103041060	3X400V~	1,65	1,2	1,6	3,24	DIRECT

## SELECTION TABLE SERIE FEKA + PANELS

PUMP MODEL	CODE	VOLTAGE	P1 MAX	kW	HP	In A	START
FEKA 600 M NA 40TH	60194419	1X230V~	0,68	0,5	0,67	3,1	DIRECT
FEKA 600 T NA 40TH	60196308	3X400V~	0,68	0,5	0,67	1,8	DIRECT
FEKA VS 550 M-NA	103040010	1X220 - 240V~	0,92	0,55	0,75	4,2	DIRECT
FEKA VS 550 T-NA	103040020	3X400V~	0,90	0,55	0,75	1,64	DIRECT
FEKA VS 750 M-NA	103040050	1X220 - 240V~	1,11	0,75	1	5,13	DIRECT
FEKA VS 750 T-NA	103040060	3X400V~	1,03	0,75	1	1,94	DIRECT
FEKA VS 1000 M-NA	103040090	1X220 - 240V~	1,46	1	1,36	6,63	DIRECT
FEKA VS 1000 T-NA	103040100	3X400V~	1,37	1	1,36	2,51	DIRECT
FEKA VS 1200 M-NA	103040130	1X220 - 240V~	1,93	1,2	1,6	8,63	DIRECT
FEKA VS 1200 T-NA	103040140	3X400V~	1,86	1,2	1,6	3,44	DIRECT

## SELECTION TABLE SERIE DRENAG FX + PANELS

PUMP MODEL	CODE	VOLTAGE	P1 MAX	kW	HP	In A
DRENAG FX 15.07 MNA	60191217	1x230V	1,1	0,8	1,1	5,1
DRENAG FX 15.07 TNA	60191218	3x400V	1	0,8	1,1	2,1
DRENAG FX 15.11 MNA	60191237	1x230V	1,5	1,2	1,6	6,8
DRENAG FX 15.11 TNA	60191238	3x400V	1,5	1,2	1,6	2,8
DRENAG FX 15.15 MNA	60191255	1x230V	2,3	1,8	2,4	10,6
DRENAG FX 15.15 TNA	60191256	3x400V	2,5	1,8	2,4	4,3
DRENAG FX 15.22 TNA	60191277	3x400V	3,1	2,3	3,1	5,2

MODEL			
EBOX BASIC 230/50-60	EBOX PLUS 230-400V/50-60	EBOX BASIC D 230/50-60	EBOX PLUS D 230-400V/50-60
60163214	60163215	60163216	60163217
•	•	•	•
	•		•
•	•	•	•
	•		•
•	•	•	•
	•		•

MODEL			
EBOX BASIC 230/50-60	EBOX PLUS 230-400V/50-60	EBOX BASIC D 230/50-60	EBOX PLUS D 230-400V/50-60
60163214	60163215	60163216	60163217
•	•	•	•
	•		•
•	•	•	•
	•		•
•	•	•	•
	•		•
•	•	•	•
	•		•
•	•	•	•
	•		•

MODEL			
EBOX BASIC 230/50-60	EBOX PLUS 230-400V/50-60	EBOX BASIC D 230/50-60	EBOX PLUS D 230-400V/50-60
60163214	60163215	60163216	60163217
•	•	•	•
	•		•
•	•	•	•
	•		•
•	•	•	•
	•		•
•	•	•	•
	•		•

# ELECTRONIC PROTECTION AND CONTROL PANELS

## SELECTION TABLE SERIE FEKA FXC + PANELS

PUMP MODEL	CODE	VOLTAGE	P1 MAX	kW	HP	In A
FEKA FXC 20.07 MNA	60191211	1x230V	0,9	0,7	0,9	4,1
FEKA FXC 20.07 TNA	60191212	3x400V	0,9	0,7	0,9	1,8
FEKA FXC 20.11 MNA	60191231	1x230V	1,4	1	1,3	6,3
FEKA FXC 20.11 TNA	60191232	3x400V	1,3	1	1,3	2,6
FEKA FXC 20.15 MNA	60191249	1x230V	2	1,5	2	9,1
FEKA FXC 20.15 TNA	60191250	3x400V	1,8	1,5	2	3,5
FEKA FXC 20.22 TNA	60191273	3x400V	2,8	2,2	2,9	4,9
FEKA FXC 25.07 MNA	60191214	1x230V	0,9	0,6	0,8	4,1
FEKA FXC 25.07 TNA	60191215	3x400V	0,9	0,6	0,8	1,8
FEKA FXC 25.11 MNA	60191234	1x230V	1,4	1,1	1,5	6,4
FEKA FXC 25.11 TNA	60191235	3x400V	1,4	1,1	1,5	2,6
FEKA FXC 25.15 MNA	60191252	1x230V	2	1,6	2,1	9,3
FEKA FXC 25.15 TNA	60191253	3x400V	1,9	1,6	2,1	3,6
FEKA FXC 25.22 TNA	60191275	3x400V	2,9	2,3	3,1	5

MODEL			
EBOX BASIC 230/50-60	EBOX PLUS 230-400V/50-60	EBOX BASIC D 230/50-60	EBOX PLUS D 230-400V/50-60
60163214	60163215	60163216	60163217
•	•	•	•
	•		•
•	•	•	•
	•		•
•	•	•	•
	•		•
•	•	•	•
	•		•
•	•	•	•
	•		•
•	•	•	•
	•		•
	•		•

## SELECTION TABLE SERIE GRINDER FX + PANELS

PUMP MODEL	CODE	VOLTAGE	P1 MAX	kW	HP	In A
GRINDER FX 15.07 MNA	60191220	1x230V	1,1	0,8	1,1	5,3
GRINDER FX 15.07 TNA	60191221	3x400V	1	0,8	1,1	2
GRINDER FX 15.11 MNA	60191240	1x230V	1,5	1,1	1,5	6,8
GRINDER FX 15.11 TNA	60191278	3x400V	1,5	1,1	1,5	2,8
GRINDER FX 15.15 MNA	60191258	1x230V	2,2	1,6	2,1	9,8
GRINDER FX 15.15 TNA	60191259	3x400V	2,1	1,6	2,1	3,8
GRINDER FX 15.22 TNA	60191279	3x400V	2,6	2,1	2,8	4,7

MODEL			
EBOX BASIC 230/50-60	EBOX PLUS 230-400V/50-60	EBOX BASIC D 230/50-60	EBOX PLUS D 230-400V/50-60
60163214	60163215	60163216	60163217
•	•	•	•
	•		•
•	•	•	•
	•		•
•	•	•	•
	•		•
	•		•

## SELECTION TABLE SERIE GRINDER FX + PANELS

PUMP MODEL	CODE	VOLTAGE	P1 MAX	kW	HP	In A
FEKA FXV 20.07 MNA	60191208	1x230V	1,4	0,9	1,2	6,4
FEKA FXV 20.07 TNA	60191209	3x400V	1,4	0,9	1,2	2,4
FEKA FXV 20.11 MNA	60191227	1x230V	1,7	1,2	1,6	8
FEKA FXV 20.11 TNA	60191228	3x400V	1,6	1,2	1,6	2,9
FEKA FXV 20.15 MNA	60194186	1x230V	2,3	1,7	2,3	10,5
FEKA FXV 20.15 TNA	60191261	3x400V	2,2	1,7	2,3	4
FEKA FXV 20.22 TNA	60191265	3x400V	2,9	2,2	2,9	5
FEKA FXV 25.07.4 TNA	60191269	3x400V	1	0,7	0,9	2,2
FEKA FXV 25.12.4 TNA	60191271	3x400V	1,7	1,2	1,6	3
FEKA FXV 25.07 MNA	60196349	1x230V	1,5	1	1,3	6,6
FEKA FXV 25.07 TNA	60196351	3x400V	1,3	1	1,3	2,3
FEKA FXV 25.11 MNA	60191230	1x230V	1,7	1,2	1,6	7,6
FEKA FXV 25.11 TNA	60191244	3x400V	1,7	1,2	1,6	3
FEKA FXV 25.15 MNA	60194201	1x230V	2,3	1,7	2,3	10,6
FEKA FXV 25.15 TNA	60191263	3x400V	2,2	1,7	2,3	4
FEKA FXV 25.22 TNA	60191267	3x400V	2,8	2,2	2,9	4,9

MODEL			
EBOX BASIC 230/50-60	EBOX PLUS 230-400V/50-60	EBOX BASIC D 230/50-60	EBOX PLUS D 230-400V/50-60
60163214	60163215	60163216	60163217
•	•	•	•
	•		•
•	•	•	•
	•		•
•	•	•	•
	•		•
	•		•
•	•	•	•
	•		•
•	•	•	•
	•		•
•	•	•	•
	•		•
•	•	•	•
	•		•
	•		•

# ELECTRONIC PROTECTION AND CONTROL PANELS

## SELECTION TABLE SERIE FKV + PANELS

PUMP MODEL	CODE	VOLTAGE	P1 MAX	KW	HP	In A
FKV 65.11.4 T5 400D	60172586	3x400V~	1,3	1,1	1,5	3,3
FKV 65 22.2 T5 400D	60171422	3x400V~	2,5	2,2	3,0	4,8
FKV 65 30.2 T5 400D	60170389	3x400V~	3,3	3,0	4,0	5,7
FKV 65 40.2 T5 400D	60171423	3x400V~	4,6	4,0	5,5	7,5
FKV 80 11.4 T5 400D	60171443	3x400V~	1,3	1,1	1,5	3,5
FKV 80 15.4 T5 400D	60171444	3x400V~	1,8	1,5	2,0	3,8
FKV 80 22.4 T5 400D	60170418	3x400V~	2,5	2,2	3,0	4,7
FKV 80 40.4 T5 400D	60171445	3x400V~	4,5	4,0	5,5	8,6
FKV 80 40.2 T5 400D	60171424	3x400V~	4,6	4,0	5,5	7,7
FKV 100 30.4 T5 400D	60171446	3x400V~	3,5	3,0	4,0	8,0
FKV 100 40.4 T5 400D	60171447	3x400V~	4,5	4,0	5,5	8,9

For pumps with power exceeding 5,5 kW or Y/D start see the ED panels.

MODEL			
EBOX BASIC 230/50-60	EBOX PLUS 230-400V/50-60	EBOX BASIC D 230/50-60	EBOX PLUS D 230-400V/50-60
60163214	60163215	60163216	60163217
	•		•
	•		•
	•		•
	•		•
	•		•
	•		•
	•		•
	•		•
	•		•
	•		•
	•		•
	•		•
	•		•

## SELECTION TABLE SERIE FKC + PANELS

PUMP MODEL	CODE	VOLTAGE	P1 MAX	KW	HP	In A
FKC 65 22.2 T5	60176795	3x400V DOL	2,6	2,2	3	4,8
FKC 65 30.2 T5	60176857	3x400V DOL	3,4	3	4,1	5,8
FKC 80 15.4 T5	60176796	3x400V DOL	1,8	1,5	2,1	3,5
FKC 80 22.4 T5	60176858	3x400V DOL	2,6	2,2	3	4,7
FKC 80 30.4 T5	60176871	3x400V DOL	3,6	3	4,1	7,6
FKC 80 40.4 T5	60176872	3x400V DOL	4,7	4	5,5	8,9
FKC 100 15.4 T5	60176859	3x400V DOL	1,8	1,5	2,1	3,9
FKC 100 22.4 T5	60176860	3x400V DOL	2,6	2,2	3	4,7
FKC 100 30.4 T5	60176873	3x400V DOL	3,3	3	4,1	7,7
FKC 100 40.4 T5	60176874	3x400V DOL	4,2	4	5,5	8,6
FKC 150 30.4 T5	60177074	3x400V DOL	3,7	3	4,1	7,8
FKC 150 40.4 T5	60176875	3x400V DOL	4,5	4	5,5	8,7

For pump power input voltages other than the standard 400V contact our sales distribution network.  
For pumps with power exceeding 4 kW or Y/D start see the ED panels.

MODEL			
EBOX BASIC 230/50-60	EBOX PLUS 230-400V/50-60	EBOX BASIC D 230/50-60	EBOX PLUS D 230-400V/50-60
60163214	60163215	60163216	60163217
	•		•
	•		•
	•		•
	•		•
	•		•
	•		•
	•		•
	•		•
	•		•
	•		•
	•		•
	•		•
	•		•

# ED

## ELECTROMECHANICAL PROTECTION AND CONTROL PANELS



exemplative photo

Supplied on the box in self-extinguishing thermoplastic material, complete with brackets for wall mounting. The framework is self-protected and protects the pump from overload, short circuits with manual reset. The models ED3M, ED3MHS, from ED2,5 to ED30T SD can handle the signal over temperature protection if the pump is provided with it.

The models ED3MHS and ED2, 4MHS are provided with additional electrolytic condenser for high startup torque.

Complete with:

- Power line switch with pad lockable door handle (except in single-phase version)
- Self-protected transformer for the power supply of the external controls
- Terminals for connecting the electric pump and the float / pressure control switches
- Terminals without potential for controlling alarm and remote installation of an audible / visual alarm
- Button on the front panel for manual operation (single phase versions)
- Switch on the front panel for manual operation - 0 - Automatic
- Amperometric protection reports
- Pump running indicator
- Voltage indicator
- Limits of use ambient temperature: - 10° C +40° C
- Degree of protection IP55

### Nominal power input voltage

230V 1~ ± 10%

400V 3~ ± 10%

**Frequency** 50-60 Hz.

### Ambient temperature operation limits

-10 °C +40 °C.

### Storage ambient temperature limit

-25 °C + 55 °C.

### Relative humidity (without condensation)

50% at 40 °C MAX (90% a 20 °C).

**Protection class** IP55.

### Panel construction

to EN 60204-1 and EN 60439-1.

MODEL	CODE	VOLTAGE 50 HZ	STARTING	NOMINAL P2		MAX CURRENT A	THERMAL PROTECTION
				KW	HP		
ED0,1M	60169998	1X220 - 240V~	direct	0,1	0,1	1	0,63-1A
ED0,3M	60170001	1X220 - 240V~	direct	0,2	0,3	2	1-1,6A
ED0,75M	60170003	1X220 - 240V~	direct	0,6	0,75	4	2,5-4A
ED1M	60170005	1X220 - 240V~	direct	0,7	1	6	4-6,3A
ED1,5M	60170006	1X220 - 240V~	direct	1,1	1,5	10	6,3-10A
ED2M	60170007	1X220 - 240V~	direct	1,5	2	14	9-14A
ED2,4M	60170009	1X220 - 240V~	direct	1,8	2,4	18	13-18A
ED3MHS / 40UF+250UF	60170010	1X220 - 240V~	direct	2,2	3	10	6,3-10A
ED3M / 40UF	60170012	1X220 - 240V~	direct	2,2	3	10	6,3-10A
ED0,08T	60170013	3X400 V~	direct	0,1	0,08	1	0,4-0,63A
ED0,5T	60170015	3X400 V~	direct	0,4	0,5	2	1-1,6A
ED1T	108320330	3X400 V~	direct	0,7	1	3	1,6-2,5A
ED1,5T	108320340	3X400 V~	direct	1,1	1,5	4	2,5-4A
ED2,5T	108320350	3X400 V~	direct	1,8	2,5	6	4-6,3A
ED4T	60170054	3X400 V~	direct	2,9	4	10	6,3-10A
ED8T	60170055	3X400 V~	direct	5,9	8	14	9-14A
ED11T	60170056	3X400 V~	direct	8,1	11	18	13-18A
ED14T	60170057	3X400 V~	direct	10,3	14	23	17-23A
ED15T	60170058	3X400 V~	direct	11,0	15	32	25-32A
ED7,5T SD	108320840	3X400/690 V~	Y/	5,5	7,5	14	9-14A
ED15T SD	60170075	3X400/690 V~	Y/	11,0	15	23	17-23A
ED20T SD	60170059	3X400/690 V~	Y/	14,7	20	32	23-32A
ED25T SD	60170060	3X400/690 V~	Y/	18,4	25	40	30-40A
ED30T SD	60170061	3X400/690 V~	Y/	22,1	30	50	37-50A

## ACCESSORIES

	<b>RELAY OIL LEVEL FOR PANELS DRAINAGE</b>	60172920
---	--	----------

\* Electric control panels ready for the addition of the oil probe module.

\*\* Electric control panels with oil probe module as standard.



# E2D

## ELECTROMECHANICAL PROTECTION AND CONTROL PANELS



exemplative photo

Supplied on the box in self-extinguishing thermoplastic material and in metal models E2D50TSD and E2D60TSD, complete with brackets for wall mounting.

The framework is self-protected and protects the pump from overload, short circuits with manual reset. The models E2D6M, E2D6MHS, from E2D5T to E2D60T SD can handle the signal over temperature protection if the pump is provided with it.

The models E2D6MHS IS provided with additional electrolytic condenser for high startup torque.

Complete with:

- Power line switch with pad lockable door handle (except in single-phase version)
- Self-protected transformer for the power supply of the external controls
- Exchange model for the alternation of starting pumps
- Terminals for connecting the electric pump and the float / pressure control switches
- Terminals without potential for controlling alarm and remote installation of an audible / visual alarm
- Button on the front panel for manual operation (single phase versions)
- Switch on the front panel for manual operation - 0 - Automatic
- Amperometric protection reports
- Pump running indicator
- Voltage indicator
- Limits of use ambient temperature: -10° C +40° C
- Degree of protection IP55

### Nominal power input voltage

230V 1~ ± 10%  
400V 3~ ± 10%

### Frequency

50-60 Hz.

### Ambient temperature operation limits

-10 °C to +40 °C.

### Storage ambient temperature limit

-25 °C to + 55 °C.

### Relative humidity (without condensation)

50% at 40 °C MAX (90% a 20 °C).

### Protection class

IP55.

### Control panel construction

According to EN 60204-1, and UNI EN 60439/-1.

MODEL	CODE	VOLTAGE 50 HZ	STARTING	NOMINAL P2		MAX CURRENT A	THERMAL PROTECTION
				KW	HP		
E2D0,6M	60170017	1X220 - 240 V~	direct	0,2	0,3	2	1-1,6A
E2D1,5M	60170019	1X220 - 240 V~	direct	0,6	0,75	4	2,5-4A
E2D2M	60170021	1X220 - 240 V~	direct	0,7	1	6	4-6,3A
E2D6M / 40UF	60170023	1X220 - 240 V~	direct	2,2	3	10	6,3-10A
E2D6MHS / 40UF+250UF	60170024	1X220 - 240 V~	direct	2,2	3	10	6,3-10A
E2D3M	60170025	1X220 - 240 V~	direct	1,1	1,5	10	6,3-10A
E2D4M	60170027	1X220 - 240 V~	direct	1,5	2	14	9-14A
E2D4,8M	60170028	1X220 - 240 V~	direct	1,8	2,4	18	13-18A
E2D2T	108320440	3X400 V~	direct	0,7	1	3	1,6-2,5A
E2D3T	108320450	3X400 V~	direct	1,1	1,5	4	2,5-4A
E2D5T	108320460	3X400 V~	direct	1,8	2,5	6	4-6,3A
E2D8T	60170062	3X400 V~	direct	2,9	4	10	6,3-10A
E2D15T	60170046	3X400 V~	direct	5,5	7,5	14	9-14A
E2D22T	60170063	3X400 V~	direct	8,1	11	18	13-18A
E2D28T	60170064	3X400 V~	direct	10,3	14	23	17-23A
E2D30T	108320750	3X400 V~	direct	11,0	15	32	25-32A
E2D15T SD	60170047	3X400/690 V~	Y/	5,5	7,5	14	9-14A
E2D30T SD	60170065	3X400/690 V~	Y/	11,0	15	23	17-23A
E2D40T SD	60170066	3X400/690 V~	Y/	14,7	20	32	23-32A
E2D50T SD	60170067	3X400/690 V~	Y/	18,4	25	40	30-40A
E2D60T SD	60170068	3X400/690 V~	Y/	22,1	30	50	37-50A

## ACCESSORIES

	<b>RELAY OIL LEVEL FOR PANELS DRAINAGE</b>	60172920
---	--	----------

\* Electric control panels ready for the addition of the oil probe module.

\*\* Electric control panels with oil probe module as standard.

# E3D

## ELECTROMECHANICAL PROTECTION AND CONTROL PANELS



exemplative photo

Supplied on the box in self-extinguishing thermoplastic material and in metal model E3D22,5TSD, complete with brackets for wall mounting.

The framework is self-protected and protects the pump from overload, short circuits with manual reset. The models E3D9M, E9D6MHS, from E3D12T to E3D90T SD can handle the signal over temperature protection if the pump is provided with it.

The models E3D9MHS is provided with additional electrolytic condenser for high startup torque.

Complete with:

- Power line switch with pad lockable door handle (except in single-phase version)
- Self-protected transformer for the power supply of the external controls
- Exchange model for the alternation of starting pumps
- Terminals for connecting the electric pump and the float / pressure control switches
- Terminals without potential for controlling alarm and remote installation of an audible / visual alarm
- Button on the front panel for manual operation (single phase versions)
- Switch on the front panel for manual operation - 0 - Automatic
- Amperometric protection reports
- Pump running indicator
- Voltage indicator
- Limits of use ambient temperature: -10° C +40° C
- Degree of protection IP55

### Nominal power input voltage

230V 1~ ± 10%  
400V 3~ ± 10%

### Frequency

50-60 Hz.

### Ambient temperature operation limits

-10 °C to +40 °C.

### Storage ambient temperature limit

-25 °C to + 55 °C.

### Relative humidity (without condensation)

50% at 40 °C MAX (90% a 20 °C).

### Protection class

IP55.

### Control panel construction

According to EN 60204-1, and UNI EN 60439/-1.

MODEL	CODE	VOLTAGE 50 HZ	STARTING	NOMINAL P2		MAX CURRENT A	THERMAL PROTECTION
				KW	HP		
E3D0,9M	60170030	1X220 - 240 V~	direct	0,2	0,3	2	1-1,6A
E3D2,25M	60170032	1X220 - 240 V~	direct	0,6	0,75	4	2,5-4A
E3D3M	60170033	1X220 - 240 V~	direct	0,7	1	6	4-6,3A
E3D9M / 40uF	60170035	1X220 - 240 V~	direct	2,2	3	10	6,3-10A
E3D9MHS / 40uF+250uF	60170037	1X220 - 240 V~	direct	2,2	3	10	6,3-10A
E3D4,5M	60170039	1X220 - 240 V~	direct	1,1	1,5	10	6,3-10A
E3D6M	60170041	1X220 - 240 V~	direct	1,5	2	14	9-14A
E3D7,2M	60170042	1X220 - 240 V~	direct	1,8	2,4	18	13-18A
E3D3T	108330440	3X400 V~	direct	0,7	1	3	1,6-2,5A
E3D4,5T	108330450	3X400 V~	direct	1,1	1,5	4	2,5-4A
E3D7,5T	60115082	3X400 V~	direct	1,8	2,5	6	4-6,3A
E3D12T	60170069	3X400 V~	direct	2,9	4	10	6,3-10A
E3D22,5T	60170070	3X400 V~	direct	5,5	7,5	14	9-14A
E3D33T	60170071	3X400 V~	direct	8,1	11	18	13-18A
E3D42T	60170049	3X400 V~	direct	10,3	14	23	17-23A
E3D45T	60170050	3X400 V~	direct	11,0	15	32	25-32A
E3D22,5T SD	60170051	3X400/690 V~	Y/	5,5	7,5	14	9-14A
E3D45T SD	60170072	3X400/690 V~	Y/	11,0	15	23	17-23A
E3D60T SD	60170073	3X400/690 V~	Y/	14,7	20	32	23-32A
E3D75T SD	60170074	3X400/690 V~	Y/	18,4	25	40	30-40A
E3D90T SD	60170052	3X400/690 V~	Y/	22,1	30	50	37-50A

# ELECTROMECHANICAL PROTECTION AND CONTROL PANELS

## SELECTION TABLE NOVA + PANELS

PUMP MODEL	CODE	VOLTAGE	P1 MAX	kW	HP	In A	START	PANEL FOR			MODEL	CODE
								1 PUMP	2 PUMPS	3 PUMPS		
NOVA 180 M NA 40TH	60195632	1X230 V~	0,19	0,2	0,27	0,9	DIRET.	•			ED0,1M	60169998
									•		E2D0,6M	60170017
										•	E3D0,9M	60170030
NOVA 200 M NA 40TH	60194402	1X230 V~	0,35	0,22	0,3	1,5	DIRET.	•			ED0,3M	60170001
									•		E2D0,6M	60170017
										•	E3D0,9M	60170030
NOVA 600 M NA 40TH	60195636	1X230 V~	0,66	0,5	0,67	3	DIRET.	•			ED0,75M	60170003
									•		E2D1,5M	60170019
										•	E3D2,25M	60170032
NOVA 600 T NA 40TH	60196306	3X400 V~	0,66	0,5	0,67	1,7	DIRET.	•			ED1T	108320330
									•		E2D2T	108320440
										•	E3D3T	108330440

## SELECTION TABLE FEKA + PANELS

PUMP MODEL	CODE	VOLTAGE	P1 MAX	kW	HP	In A	START	PANEL FOR			MODEL	CODE
								1 PUMP	2 PUMPS	3 PUMPS		
FEKA 300 M NA 40TH	60195558	1X230 V~	0,35	0,22	0,3	1,9	DIRET.	•			ED0,3M	60170001
									•		E2D0,6M	60170017
										•	E3D0,9M	60170030
FEKA 600 M NA 40TH	60194419	1X230 V~	0,68	0,5	0,67	3,1	DIRET.	•			ED0,75M	60170003
									•		E2D1,5M	60170019
										•	E3D2,25M	60170032
FEKA 600 T NA 40TH	60196308	3X400 V~	0,68	0,5	0,67	1,8	DIRET.	•			ED1T	108320330
									•		E2D2T	108320440
										•	E3D3T	108330440
FEKA VS 550 M-NA	103040010	1X220 - 240 V~	0,92	0,55	0,75	4,2	DIRET.	•			ED1M	60170005
FEKA VS 550 T-NA	103040020	3X400 V~	0,90	0,55	0,75	1,64	DIRET.		•		E2D2M	60170021
										•	E3D3M	60170033
								•			ED1T	108320330
FEKA VS 750 M-NA	103040050	1X220 - 240 V~	1,11	0,75	1	5,13	DIRET.		•		E2D2T	108320440
										•	E3D3T	108330440
								•			ED1M	60170005
FEKA VS 750 T-NA	103040060	3X400 V~	1,03	0,75	1	1,94	DIRET.		•		E2D2M	60170021
										•	E3D3M	60170033
								•			ED1T	108320330
FEKA VS 1000 M-NA	103040090	1X220 - 240 V~	1,46	1	1,36	6,63	DIRET.		•		E2D2T	108320440
										•	E3D3T	108330440
								•			ED1,5M	60170006
FEKA VS 1000 T-NA	103040100	3X400 V~	1,37	1	1,36	2,51	DIRET.		•		E2D3M	60170025
										•	E3D4,5M	60170039
								•			ED1,5T	108320340
FEKA VS 1200 M-NA	103040130	1X220 - 240 V~	1,93	1,2	1,6	8,63	DIRET.		•		E2D3T	108320450
										•	E3D4,5T	108330450
								•			ED1,5M	60170006
FEKA VS 1200 T-NA	103040140	3X400 V~	1,86	1,2	1,6	3,44	DIRET.		•		E2D3M	60170025
										•	E3D4,5M	60170039
								•			ED1,5T	108320340
								•			E2D3T	108320450
									•		E3D4,5T	108330450

# ELECTROMECHANICAL PROTECTION AND CONTROL PANELS

## SELECTION TABLE DRENAG + PANELS

PUMP MODEL	CODE	VOLTAGE	P1 MAX	kW	HP	In A	START	PANEL FOR			MODEL	CODE
								1 PUMP	2 PUMPS	3 PUMPS		
DRENAG 1000 M-NA	103041010	1X230V~	1,29	1	1,36	6	DIRET.	•			ED1M	60170005
									•		E2D2M	60170021
										•	E3D3M	60170033
DRENAG 1000 T-NA	103041020	3X400V~	1,18	1	1,36	2,43	DIRET.	•			ED1T	108320330
									•		E2D2T	108320440
										•	E3D3T	108330440
DRENAG 1200 M-NA	103041050	1X230V~	1,85	1,2	1,6	7,5	DIRET.	•			ED1,5M	60170006
									•		E2D3M	60170025
										•	E3D4,5M	60170039
DRENAG 1200 T-NA	103041060	3X400V~	1,65	1,2	1,6	3,24	DIRET.	•			ED1,5T	108320340
									•		E2D3T	108320450
										•	E3D4,5T	108330450

## SELECTION TABLE DRENAG FX + PANELS

PUMP MODEL	CODE	VOLTAGE	P1 MAX	kW	HP	In A	START	PANEL FOR			MODEL	CODE
								1 PUMP	2 PUMPS	3 PUMPS		
DRENAG FX 15.07 MNA	60191217	1x230V	1,1	0,8	1,1	5,1	DIRET.	•			ED1M	60170005
									•		E2D2M	60170021
										•	E3D3M	60170033
DRENAG FX 15.07 TNA	60191218	3x400V	1	0,8	1,1	2,1	DIRET.	•			ED1T	108320330
									•		E2D2T	108320440
										•	E3D3T	108330440
DRENAG FX 15.11 MNA	60191237	1x230V	1,5	1,2	1,6	6,8	DIRET.	•			ED1,5M	60170006
									•		E2D3M	60170025
										•	E3D4,5M	60170039
DRENAG FX 15.11 TNA	60191238	3x400V	1,5	1,2	1,6	2,8	DIRET.	•			ED1,5T	108320340
									•		E2D3T	108320450
										•	E3D4,5T	108330450
DRENAG FX 15.15 MNA	60191255	1x230V	2,3	1,8	2,4	10,6	DIRET.	•			ED2M	108320350
									•		E2D4M	108320460
										•	E3D6M	60115082
DRENAG FX 15.15 TNA	60191256	3x400V	2,5	1,8	2,4	4,3	DIRET.	•			ED2,5T	108320350
									•		E2D5T	108320460
										•	E3D7,5T	60115082
DRENAG FX 15.22 TNA	60191277	3x400V	3,1	2,3	3,1	5,2	DIRET.	•			ED2,5T	108320350
									•		E2D5T	108320460
										•	E3D7,5T	60115082

# ELECTROMECHANICAL PROTECTION AND CONTROL PANELS

## SELECTION TABLE FEKA FXC + PANELS

PUMP MODEL	CODE	VOLTAGE	P1 MAX	kW	HP	In A	START	PANEL FOR			MODEL	CODE
								1 PUMP	2 PUMPS	3 PUMPS		
FEKA FXC 20.07 MNA	60191211	1x230V	0,9	0,7	0,9	4,1	DIRET.	•			ED1M	60170005
									•		E2D2M	60170021
										•	E3D3M	60170033
FEKA FXC 20.07 TNA	60191212	3x400V	0,9	0,7	0,9	1,8	DIRET.	•			ED0,3M	60170001
									•		E2D0,6M	60170017
										•	E3D0,9M	60170030
FEKA FXC 20.11 MNA	60191231	1x230V	1,4	1	1,3	6,3	DIRET.	•			ED1,5M	60170006
									•		E2D3M	60170025
										•	E3D4,5M	60170039
FEKA FXC 20.11 TNA	60191232	3x400V	1,3	1	1,3	2,6	DIRET.	•			ED1,5T	108320340
									•		E2D3T	108320450
										•	E3D4,5T	108330450
FEKA FXC 20.15 MNA	60191249	1x230V	2	1,5	2	9,1	DIRET.	•			ED1,5M	60170006
									•		E2D3M	60170025
										•	E3D4,5M	60170039
FEKA FXC 20.15 TNA	60191250	3x400V	1,8	1,5	2	3,5	DIRET.	•			ED1,5T	108320340
									•		E2D3T	108320450
										•	E3D4,5T	108330450
FEKA FXC 20.22 TNA	60191273	3x400V	2,8	2,2	2,9	4,9	DIRET.	•			ED2,5T	108320350
									•		E2D5T	108320460
										•	E3D7,5T	60115082
FEKA FXC 25.07 MNA	60191214	1x230V	0,9	0,6	0,8	4,1	DIRET.	•			ED1M	60170005
									•		E2D2M	60170021
										•	E3D3M	60170033
FEKA FXC 25.07 TNA	60191215	3x400V	0,9	0,6	0,8	1,8	DIRET.	•			ED0,3M	60170001
									•		E2D0,6M	60170017
										•	E3D0,9M	60170030
FEKA FXC 25.11 MNA	60191234	1x230V	1,4	1,1	1,5	6,4	DIRET.	•			ED1,5M	60170006
									•		E2D3M	60170025
										•	E3D4,5M	60170039
FEKA FXC 25.11 TNA	60191235	3x400V	1,4	1,1	1,5	2,6	DIRET.	•			ED1,5T	108320340
									•		E2D3T	108320450
										•	E3D4,5T	108330450
FEKA FXC 25.15 MNA	60191252	1x230V	2	1,6	2,1	9,3	DIRET.	•			ED1,5M	60170006
									•		E2D3M	60170025
										•	E3D4,5M	60170039
FEKA FXC 25.15 TNA	60191253	3x400V	1,9	1,6	2,1	3,6	DIRET.	•			ED1,5T	108320340
									•		E2D3T	108320450
										•	E3D4,5T	108330450
FEKA FXC 25.22 TNA	60191275	3x400V	2,9	2,3	3,1	5	DIRET.	•			ED2,5T	108320350
									•		E2D5T	108320460
										•	E3D7,5T	60115082

# ELECTROMECHANICAL PROTECTION AND CONTROL PANELS

## SELECTION TABLE GRINDER FX + PANELS

PUMP MODEL	CODE	VOLTAGE	P1 MAX	kW	HP	In A	START	PANEL FOR			MODEL	CODE
								1 PUMP	2 PUMPS	3 PUMPS		
GRINDER FX 15.07 MNA	60191220	1x230V	1,1	0,8	1,1	5,3	DIRET.	•			ED1M	60170005
									•		E2D2M	60170021
										•	E3D3M	60170033
GRINDER FX 15.07 TNA	60191221	3x400V	1	0,8	1,1	2	DIRET.	•			ED1T	108320330
									•		E2D2T	108320440
										•	E3D3T	108330440
GRINDER FX 15.11 MNA	60191240	1x230V	1,5	1,1	1,5	6,8	DIRET.	•			ED1,5M	60170006
									•		E2D3M	60170025
										•	E3D4,5M	60170039
GRINDER FX 15.11 TNA	60191278	3x400V	1,5	1,1	1,5	2,8	DIRET.	•			ED1,5T	108320340
									•		E2D3T	108320450
										•	E3D4,5T	108330450
GRINDER FX 15.15 MNA	60191258	1x230V	2,2	1,6	2,1	9,8	DIRET.	•			ED2M	108320350
									•		E2D4M	108320460
										•	E3D6M	60115082
GRINDER FX 15.15 TNA	60191259	3x400V	2,1	1,6	2,1	3,8	DIRET.	•			ED1,5T	108320340
									•		E2D3T	108320450
										•	E3D4,5T	108330450
GRINDER FX 15.22 TNA	60191279	3x400V	2,6	2,1	2,8	4,7	DIRET.	•			ED2,5T	108320350
									•		E2D5T	108320460
										•	E3D7,5T	60115082

# ELECTROMECHANICAL PROTECTION AND CONTROL PANELS

## SELECTION TABLE FEKA FXV + PANELS

PUMP MODEL	CODE	VOLTAGE	P1 MAX	kW	HP	In A	START	PANEL FOR			MODEL	CODE
								1 PUMP	2 PUMPS	3 PUMPS		
FEKA FXV 20.07 MNA	60191208	1x230V	1,4	0,9	1,2	6,4	DIRET.	•			ED1,5M	60170006
									•		E2D3M	60170025
										•	E3D4,5M	60170039
FEKA FXV 20.07 TNA	60191209	3x400V	1,4	0,9	1,2	2,4	DIRET.	•			ED1T	108320340
									•		E2D2T	108320450
										•	E3D3T	108330450
FEKA FXV 20.11 MNA	60191227	1x230V	1,7	1,2	1,6	8	DIRET.	•			ED1,5M	60170006
									•		E2D3M	60170025
										•	E3D4,5M	60170039
FEKA FXV 20.11 TNA	60191228	3x400V	1,6	1,2	1,6	2,9	DIRET.	•			ED1,5T	108320340
									•		E2D3T	108320450
										•	E3D4,5T	108330450
FEKA FXV 20.15 MNA	60194186	1x230V	2,3	1,7	2,3	10,5	DIRET.	•			ED2M	108320350
									•		E2D4M	108320460
										•	E3D6M	60115082
FEKA FXV 20.15 TNA	60191261	3x400V	2,2	1,7	2,3	4	DIRET.	•			ED2,5T	108320350
									•		E2D5T	108320460
										•	E3D7,5T	60115082
FEKA FXV 20.22 TNA	60191265	3x400V	2,9	2,2	2,9	5	DIRET.	•			ED2,5T	108320350
									•		E2D5T	108320460
										•	E3D7,5T	60115082
FEKA FXV 25.07.4 TNA	60191269	3x400V	1	0,7	0,9	2,2	DIRET.	•			ED1T	108320340
									•		E2D2T	108320450
										•	E3D3T	108330450
FEKA FXV 25.12.4 TNA	60191271	3x400V	1,7	1,2	1,6	3	DIRET.	•			ED1,5T	108320340
									•		E2D3T	108320450
										•	E3D4,5T	108330450
FEKA FXV 25.07 MNA	60196349	1x230V	1,5	1	1,3	6,6	DIRET.	•			ED1,5M	60170006
									•		E2D3M	60170025
										•	E3D4,5M	60170039
FEKA FXV 25.07 TNA	60196351	3x400V	1,3	1	1,3	2,3	DIRET.	•			ED1T	108320340
									•		E2D2T	108320450
										•	E3D3T	108330450
FEKA FXV 25.11 MNA	60191230	1x230V	1,7	1,2	1,6	7,6	DIRET.	•			ED1,5M	60170006
									•		E2D3M	60170025
										•	E3D4,5M	60170039
FEKA FXV 25.11 TNA	60191244	3x400V	1,7	1,2	1,6	3	DIRET.	•			ED1,5T	108320340
									•		E2D3T	108320450
										•	E3D4,5T	108330450
FEKA FXV 25.15 MNA	60194201	1x230V	2,3	1,7	2,3	10,6	DIRET.	•			ED2M	108320350
									•		E2D4M	108320460
										•	E3D6M	60115082
FEKA FXV 25.15 TNA	60191263	3x400V	2,2	1,7	2,3	4	DIRET.	•			ED2,5T	108320350
									•		E2D5T	108320460
										•	E3D7,5T	60115082
FEKA FXV 25.22 TNA	60191267	3x400V	2,8	2,2	2,9	4,9	DIRET.	•			ED2,5T	108320350
									•		E2D5T	108320460
										•	E3D7,5T	60115082

# ELECTROMECHANICAL PROTECTION AND CONTROL PANELS

## SELECTION TABLE FEKA + PANELS

PUMP MODEL	CODE	VOLTAGE	P1 MAX	KW	HP	In A	START	PANEL FOR			MODEL	CODE
								1 PUMP	2 PUMPS	3 PUMPS		
FEKA 6200.4T	103019050	3X400/690 V~	15,8	14,9	19,9	30	Y/	•			ED20T SD	60170059
									•		E2D40T SD	60170066
										•	E3D60T SD	60170073
FEKA 6250.4T	103019060	3X400/690 V~	24	18,5	24,7	40	Y/	•			ED30T SD	60170061
									•		E2D60T SD	60170068
										•	E3D90T SD	60170052
FEKA 6300.4T	103019070	3X400/690 V~	23	21	28	45	Y/	•			ED30T SD	60170061
									•		E2D60T SD	60170068
										•	E3D90T SD	60170052
FEKA 8150. 6T	60141737	3X400 V~	11,2	8,5	11,3	22	Y/	•			ED15T SD	60170075
									•		E2D30T SD	60170065
										•	E3D45T SD	60170072
FEKA 8200. 6T	60141738	3X400 V~	13,4	11,4	15,2	27	Y/	•			ED20T SD	60170059
									•		E2D40T SD	60170066
										•	E3D60T SD	60170073
FEKA 8250. 6T	60141739	3X400 V~	17	13,5	18	36	Y/	•			ED25T SD	60170060
									•		E2D50T SD	60170067
										•	E3D75T SD	60170074
FEKA 8300. 6T	60141740	3X400 V~	22	19,3	25,7	46	Y/	•			ED30T SD	60170061
									•		E2D60T SD	60170068
										•	E3D90T SD	60170052



# ELECTROMECHANICAL PROTECTION AND CONTROL PANELS

## SELECTION TABLE FKV + PANELS

PUMP MODEL	CODE	VOLTAGE	P1 MAX	kW	HP	In A	START	PANEL FOR			MODEL	CODE
								1 PUMP	2 PUMPS	3 PUMPS		
FKV 65.11.4 T5 400D	60172586	3x400V~	1,3	1,1	1,5	3,3	DIRET.	•			ED1,5T	108320340
									•		E2D3T	108320450
										•	E3D4,5T	108330450
								•			ED2,5T	108320350
FKV 65 22.2 T5 400D	60171422	3x400V~	2,5	2,2	3,0	4,8	DIRET.		•		E2D5T	108320460
										•	E3D7,5T	60115082
								•			ED2,5T	108320350
									•		E2D5T	108320460
FKV 65 30.2 T5 400D	60170389	3x400V~	3,3	3,0	4,0	5,7	DIRET.			•	E3D7,5T	60115082
								•			ED4T	60170054
									•		E2D8T	60170062
										•	E3D12T	60170069
FKV 65 40.2 T5 400D	60171423	3x400V~	4,6	4,0	5,5	7,5	DIRET.	•			ED1,5T	108320340
									•		E2D3T	108320450
										•	E3D4,5T	108330450
								•			ED1,5T	108320340
FKV 80 11.4 T5 400D	60171443	3x400V~	1,3	1,1	1,5	3,5	DIRET.		•		E2D3T	108320450
										•	E3D4,5T	108330450
								•			ED1,5T	108320340
									•		E2D3T	108320450
FKV 80 15.4 T5 400D	60171444	3x400V~	1,8	1,5	2,0	3,8	DIRET.			•	E3D4,5T	108330450
								•			ED2,5T	108320350
									•		E2D5T	108320460
										•	E3D7,5T	60115082
FKV 80 22.4 T5 400D	60170418	3x400V~	2,5	2,2	3,0	4,7	DIRET.	•			ED4T	60170054
									•		E2D8T	60170062
										•	E3D12T	60170069
								•			ED4T	60170054
FKV 80 40.4 T5 400D	60171445	3x400V~	4,5	4,0	5,5	8,6	DIRET.		•		E2D8T	60170062
										•	E3D12T	60170069
								•			ED4T	60170054
									•		E2D8T	60170062
FKV 80 40.2 T5 400D	60171424	3x400V~	4,6	4,0	5,5	7,7	DIRET.			•	E3D12T	60170069
								•			ED7,5T SD	108320840
									•		E2D15T SD	60170047
										•	E3D22,5T SD	60170051
FKV 80 60.2 T5 400Y/D	60171425	3x400V~	6,9	6,0	8,2	11,7	Y/	•			ED7,5T SD	108320840
									•		E2D15T SD	60170047
										•	E3D22,5T SD	60170051
								•			ED7,5T SD	108320840
FKV 80 75.2 T5 400Y/D	60170434	3x400V~	8,3	7,5	10,2	13,7	Y/		•		E2D15T SD	60170047
										•	E3D22,5T SD	60170051
								•			ED15T SD	60170075
									•		E2D30T SD	60170065
FKV 80 92.2 T5 400Y/D	60171426	3x400V~	10,2	9,2	12,5	18,0	Y/			•	E3D45T SD	60170072
								•			ED15T SD	60170075
									•		E2D30T SD	60170065
										•	E3D45T SD	60170072
FKV 80 110.2 T5 400Y/D	60170429	3x400V~	12,1	11,0	15,0	21,0	Y/	•			ED4T	60170054
									•		E2D8T	60170062
										•	E3D12T	60170069
								•			ED4T	60170054
FKV 100 30.4 T5 400D	60171446	3x400V~	3,5	3,0	4,0	8,0	DIRET.		•		E2D8T	60170062
										•	E3D12T	60170069
								•			ED4T	60170054
									•		E2D8T	60170062
FKV 100 40.4 T5 400D	60171447	3x400V~	4,5	4,0	5,5	8,9	DIRET.			•	E3D12T	60170069
								•			ED7,5T SD	108320840
									•		E2D15T SD	60170047
										•	E3D22,5T SD	60170051
FKV 100 55.4 T5 400Y/D	60171448	3x400V~	6,2	5,5	7,5	11,3	Y/	•			ED15T SD	60170075
									•		E2D30T SD	60170065
										•	E3D45T SD	60170072
								•			ED15T SD	60170075
FKV 100 75.4 T5 400Y/D	60170428	3x400V~	8,3	7,5	10,0	14,3	Y/		•		E2D30T SD	60170065
										•	E3D45T SD	60170072
								•			ED15T SD	60170075
									•		E2D30T SD	60170065

# ELECTROMECHANICAL PROTECTION AND CONTROL PANELS

## SELECTION TABLE FKC + PANELS

PUMP MODEL	CODE	VOLTAGE	P1 MAX	kW	HP	In A	START	PANEL FOR			MODEL	CODE
								1 PUMP	2 PUMPS	3 PUMPS		
FKC 65 22.2 T5	60176795	3x400V~	2,6	2,2	3,0	4,8	DIRET.	•			ED2,5T	108320350
									•		E2D5T	108320460
										•	E3D7,5T	60115082
FKC 65 30.2 T5	60176857	3x400V~	3,4	3,0	4,1	5,8	DIRET.	•			ED2,5T	108320350
									•		E2D5T	108320460
										•	E3D7,5T	60115082
FKC 80 15.4 T5	60176796	3x400V~	1,8	1,5	2,1	3,5	DIRET.	•			ED1,5T	108320340
									•		E2D3T	108320450
										•	E3D4,5T	108330450
FKC 80 22.4 T5	60176858	3x400V~	2,6	2,2	3,0	4,7	DIRET.	•			ED2,5T	108320350
									•		E2D5T	108320460
										•	E3D7,5T	60115082
FKC 80 30.4 T5	60176871	3x400V~	3,6	3,0	4,1	7,6	DIRET.	•			ED4T	60170054
									•		E2D8T	60170062
										•	E3D12T	60170069
FKC 80 40.4 T5	60176872	3x400V~	4,7	4,0	5,5	8,9	DIRET.	•			ED4T	60170054
									•		E2D8T	60170062
										•	E3D12T	60170069
FKC 80 55.4 T5	60176854	3x400V~	6,3	5,5	7,5	8,6	Y/	•			ED7,5T SD	108320840
									•		E2D15T SD	60170047
										•	E3D22,5T SD	60170051
FKC 80 75.4 T5	60176855	3x400V~	8,5	7,5	10,3	14,1	Y/	•			ED15T SD	60170075
									•		E2D30T SD	60170065
										•	E3D45T SD	60170072
FKC 100 15.4 T5	60176859	3x400V~	1,8	1,5	2,1	3,9	DIRET.	•			ED2,5T	108320350
									•		E2D5T	108320460
										•	E3D7,5T	60115082
FKC 100 22.4 T5	60176860	3x400V~	2,6	2,2	3,0	4,7	DIRET.	•			ED2,5T	108320350
									•		E2D5T	108320460
										•	E3D7,5T	60115082
FKC 100 30.4 T5	60176873	3x400V~	3,3	3,0	4,1	7,7	DIRET.	•			ED4T	60170054
									•		E2D8T	60170062
										•	E3D12T	60170069
FKC 100 40.4 T5	60176874	3x400V~	4,2	4,0	5,5	8,6	DIRET.	•			ED4T	60170054
									•		E2D8T	60170062
										•	E3D12T	60170069
FKC 100 55.4 T5	60176850	3x400V~	5,7	5,5	7,5	11,4	Y/	•			ED7,5T SD	60170069
									•		E2D15T SD	60170047
										•	E3D22,5T SD	60170051
FKC 100 75.4 T5	60176851	3x400V~	8,1	7,5	10,3	14,6	Y/	•			ED15T SD	60170075
									•		E2D30T SD	60170065
										•	E3D45T SD	60170072
FKC 150 30.4 T5	60177074	3x400V~	3,7	3,0	4,1	7,8	DIRET.	•			ED4T	60170054
									•		E2D8T	60170062
										•	E3D12T	60170069
FKC 150 40.4 T5	60176875	3x400V~	4,5	4,0	5,5	8,7	DIRET.	•			ED4T	60170054
									•		E2D8T	60170062
										•	E3D12T	60170069
FKC 150 55.4 T5	60176852	3x400V~	6,0	5,5	7,5	11,3	Y/	•			ED7,5T SD	108320840
									•		E2D15T SD	60170047
										•	E3D22,5T SD	60170051
FKC 150 75.4 T5	60176853	3x400V~	8,4	7,5	10,3	14,7	Y/	•			ED15T SD	60170075
									•		E2D30T SD	60170065
										•	E3D45T SD	60170072



CATCH US **IF YOU CAN...**



**esybox DIVER**

7" ELECTRONIC MULTISTAGE SUBMERSIBLE PUMPS WITH INVERTER





**IDEA**  
4" PERIPHERAL SUBMERSIBLE PUMPS  
  
D1 **PAG. 268**



**DIVER - DIVER HF**  
5" MULTISTAGE SUBMERSIBLE PUMPS  
  
A9 **PAG. 269**



**PULSAR**  
5" MULTISTAGE SUBMERSIBLE PUMPS  
  
D3 **PAG. 271**



**PULSAR DRY**  
5" MULTISTAGE SUBMERSIBLE PUMPS  
  
D3 **PAG. 272**



**DIVER 6** **NEW**  
SUBMERSIBLE  
MULTI-IMPELLER PUMPS  
  
DF **PAG. 273**



**DIVERTRON**  
6" ELECTRONIC MULTISTAGE  
SUBMERSIBLE PUMPS  
  
AA EZ **PAG. 274**



**DTRON 2** **NEW**  
7" ELECTRONIC MULTISTAGE  
SUBMERSIBLE PUMPS  
  
AA **PAG. 276**



**DTRON 3** **NEW**  
7" ELECTRONIC MULTISTAGE  
SUBMERSIBLE PUMPS  
  
AA **PAG. 277**



**ESYBOX DIVER** **NEW**  
7" MULTISTAGE SUBMERSIBLE PUMPS  
WITH VARIABLE FREQUENCY DRIVE  
  
E7 **PAG. 278**



**MICRA HS**  
HIGH SPEED 3"  
SUBMERSIBLE PUMPS  
  
F4 **PAG. 279**



**MICRA**  
3" SUBMERSIBLE PUMPS  
  
D4 **PAG. 280**



**S4 AMEIRA**  
4" SUBMERSIBLE PUMPS  
  
FN FP FO FQ FL **PAG. 281**



**S4**  
4" SUBMERSIBLE PUMPS **ONLY FOR EXTRA EU MARKETS**  
  
FV FZ FU **PAG. 286**



**4GG**  
4" SUBMERSIBLE MOTORS  
  
E1 **PAG. 289**



**4GX**  
4" SUBMERSIBLE MOTORS  
  
F1 **PAG. 290**



**4TW**  
4" SUBMERSIBLE MOTORS  
  
E2 **PAG. 291**



**40L**  
4" SUBMERSIBLE MOTORS  
  
E3 **PAG. 292**



**SS6**  
6" SUBMERSIBLE PUMPS  
  
DK **PAG. 293**



**SS7**  
7" SUBMERSIBLE PUMPS  
  
EY **PAG. 300**



**SS8**  
8" SUBMERSIBLE PUMPS  
  
DU **PAG. 302**



**SS10**  
10" SUBMERSIBLE PUMPS  
  
DW **PAG. 304**



**SMC6**  
6" SUBMERSIBLE PUMPS  
  
DK **PAG. 305**



**SMC8**  
8" SUBMERSIBLE PUMPS  
  
DU **PAG. 307**



**SMC10**  
10" SUBMERSIBLE PUMPS  
  
DW **PAG. 310**



**SMC12**  
12" SUBMERSIBLE PUMPS  
  
DY **PAG. 312**



**6GF - 6GX**  
6" SUBMERSIBLE MOTORS  
  
E4 **PAG. 313**



**TR6**  
6" SUBMERSIBLE MOTORS  
  
CW **PAG. 314**



**TR8**  
8" SUBMERSIBLE MOTORS  
  
CX **PAG. 315**



**TR10**  
10" SUBMERSIBLE MOTORS  
  
CY **PAG. 316**



**TR12**  
12" SUBMERSIBLE MOTORS  
  
CZ **PAG. 317**



**ACCESSORI**

**PAG. 319**

# IDEA

## 4" PERIPHERAL SUBMERSIBLE PUMPS



SINGLE-PHASE



THREE-PHASE

4" peripheral submersible pump, available as single impeller model (version 75 or 100) or double-impeller model (version 150) version, designed for water pressurization, lifting water from wells and for gardening and irrigation activities in residential building service. Single block pump: the hydraulic part and motor are mechanically coupled with a mechanical seal. Cast iron pump body and motor support with cathoporesis coating. Brass peripheral-type impeller. Pump equipped with power cable (15 meter) and nylon support rope of the same length as the cable, useful for immersion in the well. Asynchronous submersible motor with encapsulated stator. Single-phase version with thermoamperometric protection and capacitor included. Protection of the three-phase version by the user.

**Protection rating** IP 68

**Insulation class**

**Liquid temperature range** from 0° C to +35° C

**Max. no. of starts** 20/h

**Maximum submersion** 20 m.

**Installation** in 4" or larger wells, tanks or cisterns, vertically.

**Liquid quality requirements** clean, free of solid or abrasive contaminants, non-viscous, chemically neutral, close to the properties of water.

**Removable H07RN-F power cable, length 15 m.**

**Supplied with 15 m of nylon rope.**

MODEL	CODE	ELECTRICAL DATA							HYDRAULIC DATA (n ~ 2800 1/min)								
		VOLTAGE 50 Hz	P1 MAX kW	P2 NOMINAL		In A	CAPACITOR		Q m <sup>3</sup> /h l/min	0,4	0,6	0,9	1,2	1,5	1,8	2,1	2,4
				kW	HP		µF	Vc		7	10	15	20	25	30	35	40
IDEA 75 M	60122482	1x230V ~	0,8	0,55	0,75	4	16	450		H (m)	39	37	32	27,6	22,5	17,6	12,2
IDEA 100 M	60122483	1x230V ~	1,1	0,75	1	4,7	20	450	52		48,3	41,4	34,6	28	21,2	14,4	7,3
IDEA 150 M	60133713	1x230V ~	2,2	1	1,5	10,5	35	450	90		81	70	60	48	35	22	10
IDEA 75 T	60122353	3x400V ~	0,65	0,55	0,75	1,5	-	-	39		37	32	27,6	22,5	17,6	12,2	6,8
IDEA 100T	60122354	3x400V ~	1,1	0,75	1	2,3	-	-	52		48,3	41,4	34,6	28	21,2	14,4	7,3
IDEA 150T	60140605	3x400V ~	2,5	1	1,5	4,3	-	-	90		81	70	60	48	35	22	10

# DIVER - DIVER HF

5" MULTISTAGE SUBMERSIBLE PUMPS



5" submersible multi-impeller single block pumps. Designed for pressurization, gardening, irrigation and lifting water in residential building service. They operate immersed in wells and first collection tanks or cisterns. The motor is located above the hydraulic part and is cooled by the pumped liquid.

Detachable 10 meter power cable supplied as standard. Impellers and diffusers are made of technopolymer.

The Diver HF version allows higher flow. Both version are available in manual or automatic (version with a float switch) mode. Single-phase version with control panel with capacitor and thermo-ampometric protection with manual reset, the control panel must be ordered separately. Protection of the three-phase version by the user.

**Protection rating** IP 68

**Insulation class** F

**Standard voltage input**

Single-phase: 230 V / 50 Hz.

Three-phase 230V / 50Hz and 400 V / 50 Hz

**Power cable** Removable H07RN-F, length 10 m.

<sup>(1)</sup> Required for single-phase versions

ACCESSORIES  
PAG. 319

## DIVER

MODEL	CODE	ELECTRICAL DATA				HYDRAULIC DATA											DNM GAS	WEIGHT KG
		VOLTAGE 50 Hz	P1 kW	P2		In A	Q m <sup>3</sup> /h	H (m)										
				kW	HP			0	0,6	1,2	1,8	2,4	3	3,6	4,2	4,8		
DIVER 75 M-A	60121469	1x230 V~	0,85	0,55	0,75	4,6	39	35	33	30	26	22	18	14	9	1"1/4	9	
DIVER 75 M-NA	60121655	1x230 V~	0,85	0,55	0,75	4,6	39	35	33	30	26	22	18	14	9	1"1/4	9	
DIVER 75 T-NA	60121656	3x230 V~	0,8	0,55	0,75	2,9	39	35	33	30	26	22	18	14	9	1"1/4	9	
DIVER 75 T-NA	60121657	3x400 V~	0,8	0,55	0,75	1,7	39	35	33	30	26	22	18	14	9	1"1/4	9	
DIVER 100 M-A	60121470	1x230 V~	1,1	0,75	1	5,9	55	50	45	41	35	30	25	18	11	1"1/4	11	
DIVER 100 M-NA	60121658	1x230 V~	1,1	0,75	1	5,9	55	50	45	41	35	30	25	18	11	1"1/4	11	
DIVER 100 T-NA	60121659	3x230 V~	1,2	0,75	1	4,2	55	50	45	41	35	30	25	18	11	1"1/4	11	
DIVER 100 T-NA	60121660	3x400 V~	1,2	0,75	1	2,4	55	50	45	41	35	30	25	18	11	1"1/4	11	
DIVER 150 M-A	60121471	1x230 V~	1,6	1	1,5	7,8	80	72	67	60	52	45	35	26	16	1"1/4	16	
DIVER 150 M-NA	60121661	1x230 V~	1,6	1	1,5	7,8	80	72	67	60	52	45	35	26	16	1"1/4	16	
DIVER 150 T-NA	60121662	3x230 V~	1,55	1	1,5	5,7	80	72	67	60	52	45	35	26	16	1"1/4	16	
DIVER 150 T-NA	60121663	3x400 V~	1,55	1	1,5	3,3	80	72	67	60	52	45	35	26	16	1"1/4	16	
DIVER 150 M-A *	60141617	1x230 V~	1,6	1	1,5	7,8	80	72	67	60	52	45	35	26	16	1"1/4	17	
DIVER 150 M-NA*	60141618	1x230 V~	1,6	1	1,5	7,8	80	72	67	60	52	45	35	26	16	1"1/4	17	
DIVER 150 T-NA *	60141619	3x230 V~	1,55	1	1,5	5,7	80	72	67	60	52	45	35	26	16	1"1/4	17	
DIVER 150 T-NA *	60141620	3x400 V~	1,55	1	1,5	3,3	80	72	67	60	52	45	35	26	16	1"1/4	17	
DIVER 200 M-A	60121472	1x230 V~	2,3	1,5	2	10,7	101	96	90	85	70	60	47	35	21	1"1/4	21	
DIVER 200 M-NA	60121664	1x230 V~	2,3	1,5	2	10,7	101	96	90	85	70	60	47	35	21	1"1/4	21	
DIVER 200 T-NA	60121476	3x230 V~	2,15	1,5	2	8,5	101	96	90	85	70	60	47	35	21	1"1/4	21	
DIVER 200 T-NA	60121665	3x400 V~	2,15	1,5	2	4,9	101	96	90	85	70	60	47	35	21	1"1/4	21	
DIVER 200 M-A *	60141621	1x230 V~	2,3	1,5	2	10,7	101	96	90	85	70	60	47	35	21	1"1/4	21	
DIVER 200 M-NA*	60141623	1x230 V~	2,3	1,5	2	10,7	101	96	90	85	70	60	47	35	21	1"1/4	21	
DIVER 200 T-NA*	60141624	3x230 V~	2,15	1,5	2	8,5	101	96	90	85	70	60	47	35	21	1"1/4	21	
DIVER 200 T-NA *	60141625	3x400 V~	2,15	1,5	2	4,9	101	96	90	85	70	60	47	35	21	1"1/4	21	

A= automatic with float NA= non automatic without float

\* 20 mt. CABLE INCLUDED

# DIVER - DIVER HF

5" MULTISTAGE SUBMERSIBLE PUMPS



## DIVER HF

MODEL	CODE	ELECTRICAL DATA					HYDRAULIC DATA											DNM GAS	WEIGHT KG
		VOLTAGE 50 Hz	P1 kW	P2		In A	Q m <sup>3</sup> /h l/min	0	1,5	3	4,5	6	7,5	9	10,5	12			
				kW	HP			0	25	50	75	100	125	150	175	200			
DIVER 100 HF M-A	60121666	1x230 V~	1,1	0,75	1	6,2	H (m)	30	28	26	24	22	20	16	13	10	1"1/4	11,5	
DIVER 100 HF M-NA	60121667	1x230 V~	1,1	0,75	1	6,2		30	28	26	24	22	20	16	13	10	1"1/4	11,5	
DIVER 100 HF T-NA	60121668	3x230 V~	1,2	0,75	1	4,3		30	28	26	24	22	20	16	13	10	1"1/4	11,5	
DIVER 100 HF T-NA	60121669	3x400 V~	1,2	0,75	1	2,5		30	28	26	24	22	20	16	13	10	1"1/4	11,5	
DIVER 150 HF M-A	60121670	1x230 V~	1,7	1	1,5	8,1		42	40	38	35	32	28	24	20	15	1"1/4	13	
DIVER 150 HF M-NA	60121671	1x230 V~	1,7	1	1,5	8,1		42	40	38	35	32	28	24	20	15	1"1/4	13	
DIVER 150 HF T-NA	60121473	3x230 V~	1,8	1	1,5	6		42	40	38	35	32	28	24	20	15	1"1/4	13	
DIVER 150 HF T-NA	60121672	3x400 V~	1,8	1	1,5	3,5		42	40	38	35	32	28	24	20	15	1"1/4	13	
DIVER 200 HF M-A	60121673	1x230 V~	2,15	1,5	2	10,8		59	55	51	48	44	39	34	28	20	1"1/4	15,2	
DIVER 200 HF M-NA	60121674	1x230 V~	2,15	1,5	2	10,8		59	55	51	48	44	39	34	28	20	1"1/4	15,2	
DIVER 200 HF T-NA	60121474	3x230 V~	2,1	1,5	2	8,5		59	55	51	48	44	39	34	28	20	1"1/4	15,2	
DIVER 200 HF T-NA	60121475	3x400 V~	2,1	1,5	2	4,9		59	55	51	48	44	39	34	28	20	1"1/4	15,2	

A= automatic with float NA= non automatic without float

COMMAND AND CONTROL SYSTEMS

CIRCULATORS AND IN-LINE PUMPS

MULTISTAGE CENTRIFUGAL AND SELF-PRIMING PUMPS

SWIMMING POOL, POND AND SALT WATER PUMPS

CENTRIFUGAL PUMPS

SUBMERSIBLE PUMPS

SUBMERSIBLE PUMPS AND SUBMERSIBLE MOTORS

PRESSURE UNITS



# PULSAR

## 5" MULTISTAGE SUBMERSIBLE PUMPS



5" multi-impeller monobloc submersible pump designed for pressurization, gardening and irrigation and lifting water in residential building service. These pumps work immersed in wells and first collection tanks and cisterns. The suction takes place through a filter located in the lower part of the pump.

The motor is located above the hydraulic part and is cooled by the pumped liquid. Robust components allow the pump to run dry for short periods. Impellers and diffusers are in technopolymer. Double mechanical seal in carbon ceramic on motor side and silicon carbide/silicon carbide on pump side, with interposed oil chamber. Power cable, thermo-ampereometric protection and starting capacitor included in the single-phase version, also available in automatic version with float. Protection by the user in the three-phase version.

### Operating range

from 0.9 to 7.2 m<sup>3</sup>/h with head up to 86 metres.

**Maximum permissible sand quantity** 50 g/m<sup>3</sup>

**Motor protection level** IP 68

**Insulation class** F

**Liquid temperature range** From 0° C to +40° C

**Standard cables** 20 m H07 RN F cable type.

**Cable complete with SCHUKO plug EEC 7-VII-UNEL 47166-68** for the single-phase version.

Single-phase versions can be equipped with or without float switches for automatic operation.

MODEL	CODE	ELECTRICAL DATA					Q m <sup>3</sup> /h l/min	HYDRAULIC DATA								DNM GAS	WEIGHT KG
		VOLTAGE 50 Hz	P1 KW	P2		In A		0	1,2	2,4	3,6	4,8	6	7,2			
				KW	HP										0		
PULSAR 30/50 M-A	104160000	1x230V~	0,94	0,55	0,75	4,5	42	38,2	33,8	24,8	13,5				1 1/4" G	17,3	
PULSAR 30/50 M-NA	104160010	1x230V~	0,94	0,55	0,75	4,5	42	38,2	33,8	24,8	13,5				1 1/4" G	16,7	
PULSAR 30/50 T-NA	104160420	3x230V~	0,87	0,55	0,75	2,85	42	38,2	33,8	24,8	13,5				1 1/4" G	17,3	
PULSAR 30/50 T-NA	104160020	3x400V~	0,87	0,55	0,75	1,65	42	38,2	33,8	24,8	13,5				1 1/4" G	17,3	
PULSAR 40/50 M-A	104160030	1x230V~	1,12	0,75	1	5,2	56	51	45	33	18				1 1/4" G	17,5	
PULSAR 40/50 M-NA	104160040	1x230V~	1,12	0,75	1	5,2	56	51	45	33	18				1 1/4" G	17	
PULSAR 40/50 T-NA	104160450	3x230V~	1,03	0,75	1	3,2	56	51	45	33	18				1 1/4" G	17,5	
PULSAR 40/50 T-NA	104160050	3x400V~	1,03	0,75	1	1,85	56	51	45	33	18				1 1/4" G	17,5	
PULSAR 50/50 M-A	104160060	1x230V~	1,45	1	1,36	6,5	72	65,5	58	43,6	24,5				1 1/4" G	18,5	
PULSAR 50/50 M-NA	104160070	1x230V~	1,45	1	1,36	6,5	72	65,5	58	43,6	24,5				1 1/4" G	18	
PULSAR 50/50 T-NA	104160480	3x230V~	1,35	1	1,36	4,15	72	65,5	58	43,6	24,5				1 1/4" G	18,5	
PULSAR 50/50 T-NA	104160080	3x400V~	1,35	1	1,36	2,4	72	65,5	58	43,6	24,5				1 1/4" G	18,5	
PULSAR 65/50 M-A	104160090	1x230V~	1,70	1,2	1,6	7,8	86	78,5	70	52,8	29				1 1/4" G	19,5	
PULSAR 65/50 M-NA	104160100	1x230V~	1,70	1,2	1,6	7,8	86	78,5	70	52,8	29				1 1/4" G	19	
PULSAR 65/50 T-NA	104160510	3x230V~	1,60	1,2	1,6	5	86	78,5	70	52,8	29				1 1/4" G	19,5	
PULSAR 65/50 T-NA	104160110	3x400V~	1,60	1,2	1,6	2,9	86	78,5	70	52,8	29				1 1/4" G	19,5	
PULSAR 30/80 M-A	104160230	1x230V~	1,12	0,75	1	5,2	47	45	42	36	30	21	12		1 1/4" G	17,5	
PULSAR 30/80 M-NA	104160240	1x230V~	1,12	0,75	1	5,2	47	45	42	36	30	21	12		1 1/4" G	17	
PULSAR 30/80 T-NA	104160650	3x230V~	1,03	0,75	1	3,2	47	45	42	36	30	21	12		1 1/4" G	17,5	
PULSAR 30/80 T-NA	104160250	3x400V~	1,03	0,75	1	1,85	47	45	42	36	30	21	12		1 1/4" G	17,5	
PULSAR 40/80 M-A	104160260	1x230V~	1,45	1	1,36	6,5	64	61	56,8	50	41,5	30,5	16,2		1 1/4" "	18,5	
PULSAR 40/80 M-NA	104160270	1x230V~	1,45	1	1,36	6,5	64	61	56,8	50	41,5	30,5	16,2		1 1/4" "	18	
PULSAR 40/80 T-NA	104160680	3x230V~	1,35	1	1,36	4,15	64	61	56,8	50	41,5	30,5	16,2		1 1/4" "	18,5	
PULSAR 40/80 T-NA	104160280	3x400V~	1,35	1	1,36	2,4	64	61	56,8	50	41,5	30,5	16,2		1 1/4" "	18,5	
PULSAR 50/80 M-A	104160290	1x230V~	1,70	1,2	1,6	7,8	77	73,2	68	60	50	37	19,6		1 1/4" "	19,5	
PULSAR 50/80 M-NA	104160300	1x230V~	1,70	1,2	1,6	7,8	77	73,2	68	60	50	37	19,6		1 1/4" "	19	
PULSAR 50/80 T-NA	104160710	3x230V~	1,60	1,2	1,6	5	77	73,2	68	60	50	37	19,6		1 1/4" "	19,5	
PULSAR 50/80 T-NA	104160310	3x400V~	1,60	1,2	1,6	2,9	77	73,2	68	60	50	37	19,6		1 1/4" "	19,5	

**A**= automatic with float **NA**= non automatic without float

# PULSAR DRY

5" MULTISTAGE SUBMERSIBLE PUMPS



The PULSAR DRY pumps are used in lifting and pressurisation systems for water from primary collection tanks or wells and are suitable for providing pressurised water in domestic systems, small-scale farming and sprinkler systems for gardens and vegetable gardens. The pump is extremely silent and this feature makes it suitable for use with pressurisation systems in unventilated rooms or in areas prone to flooding. Single-piece multi-stage bore-hole pump or of surface with hydraulic assembly positioned under the motor which is cooled by the pumped liquid. Impellers, diffusers, filter and oil sump in abrasion-proof thermoplastic. Pump liner, stator sleeve, upper head with sleeve and sealing ring in AISI 304 steel. Upper and lower bearing supports in dezincification-proof pressed brass. Rotor shaft extension in AISI 304. Elastomers in NBR. Stainless steel hardware. Double mechanical seal separated by an oil chamber, in ceramic/carbon on the motor side and carborundum/carborundum on the pump side. The sealing system ensures the motor remains airtight and the mechanical seal holds even after brief periods of no-water operation.

Continuous service asynchronous submersible motor. Stator incorporated in an AISI 304 stainless steel airtight casing with a cover housing the cables and capacitor. Rotor mounted on oversized ball bearings to ensure silent running and long life. Incorporated thermal current protection and permanently connected capacitor in the single-phase version. As regards three-phase protection, a motor overload cut out should be fitted, in accordance with current standards. Built to IEC 2-3 and IEC 61-69 (EN 60335-2-41).

### Operating range

from 0.9 to 7.2 m<sup>3</sup>/h with a head of up to 86 m

**Max. quantity of sand in water** 50 gr/m<sup>3</sup>

**Protection level of motor** IP 68

**Protection class of motor** F

**Liquid temperature range** da 0°C a +40°C

**Maximum depth of immersion** 20 metres

**Standard cables** 15 m of H07 RN F cable complete with SCHUKO EEC 7-VII-UNEL 47166-68 plug for the single-phase version. The single-phase versions can be supplied with or without floats for automatic operation.

MODEL	CODE	ELECTRICAL DATA					HYDRAULIC DATA										DNM GAS	DNA GAS	WEIGHT KG
		VOLTAGE 50 Hz	P1 KW	P2		In A	Q m <sup>3</sup> /h l/min	H (m)											
				KW	HP			0	1,2	2,4	3,6	4,8	6	7,2					
PULSAR DRY 30/50 M-NA	104165200	1x230V~	0,94	0,55	0,75	4,4	42	38,2	33,8	24,8	13,5						1 1/4"	1 1/4"	16,7
PULSAR DRY 30/50 T-NA	104165410	3x230V~	0,87	0,55	0,75	2,85	42	38,2	33,8	24,8	13,5						1 1/4"	1 1/4"	17,3
PULSAR DRY 30/50 T-NA	104165210	3x400V~	0,87	0,55	0,75	1,65	42	38,2	33,8	24,8	13,5						1 1/4"	1 1/4"	17,3
PULSAR DRY 40/50 M-NA	104165220	1x230V~	1,12	0,75	1	5,2	56	51	45	33	18						1 1/4"	1 1/4"	17,3
PULSAR DRY 40/50 T-NA	104165430	3x230V~	1,03	0,75	1	3,2	56	51	45	33	18						1 1/4"	1 1/4"	17
PULSAR DRY 40/50 T-NA	104165230	3x400V~	1,03	0,75	1	1,85	56	51	45	33	18						1 1/4"	1 1/4"	17
PULSAR DRY 50/50 M-NA	104165240	1x230V~	1,45	1	1,36	6,5	72	65,5	58	43,6	24,5						1 1/4"	1 1/4"	18
PULSAR DRY 50/50 T-NA	104165450	3x230V~	1,35	1	1,36	4,15	72	65,5	58	43,6	24,5						1 1/4"	1 1/4"	18,5
PULSAR DRY 50/50 T-NA	104165250	3x400V~	1,35	1	1,36	2,4	72	65,5	58	43,6	24,5						1 1/4"	1 1/4"	18,5
PULSAR DRY 65/50 M-NA	104165260	1x230V~	1,70	1,2	1,6	7,8	86	78,5	70	52,8	29						1 1/4"	1 1/4"	19
PULSAR DRY 60/50 T-NA	104165470	3x230V~	1,60	1,2	1,6	5	86	78,5	70	52,8	29						1 1/4"	1 1/4"	19,5
PULSAR DRY 65/50 T-NA	104165270	3x400V~	1,60	1,2	1,6	2,9	86	78,5	70	52,8	29						1 1/4"	1 1/4"	19,5
PULSAR DRY 30/80 M-NA	104165300	1x230V~	1,12	0,75	1	5,2	51	48,2	44,8	39,2	32,4	23,5	13				1 1/4"	1 1/4"	17
PULSAR DRY 30/80 T-NA	104165510	3x230V~	1,03	0,75	1	3,2	51	48,2	44,8	39,2	32,4	23,5	13				1 1/4"	1 1/4"	17,5
PULSAR DRY 30/80 T-NA	104165310	3x400V~	1,03	0,75	1	1,85	51	48,2	44,8	39,2	32,4	23,5	13				1 1/4"	1 1/4"	17,5
PULSAR DRY 40/80 M-NA	104165320	1x230V~	0,78	1	1,36	6,5	64	61	56,8	50	41,5	30,5	16,2				1 1/4"	1 1/4"	18
PULSAR DRY 40/80 T-NA	104165530	3x230V~	0,60	1	1,36	4,15	64	61	56,8	50	41,5	30,5	16,2				1 1/4"	1 1/4"	18,5
PULSAR DRY 40/80 T-NA	104165330	3x400V~	0,60	1	1,36	2,4	64	61	56,8	50	41,5	30,5	16,2				1 1/4"	1 1/4"	18,5
PULSAR DRY 50/80 M-NA	104165340	1x230V~	0,94	1,2	1,6	7,8	77	73,2	68	60	50	37	19,6				1 1/4"	1 1/4"	19
PULSAR DRY 50/80 T-NA	104165550	3x230V~	0,87	1,2	1,6	5	77	73,2	68	60	50	37	19,6				1 1/4"	1 1/4"	19,5
PULSAR DRY 50/80 T-NA	104165350	3x400V~	0,87	1,2	1,6	2,9	77	73,2	68	60	50	37	19,6				1 1/4"	1 1/4"	19,5

**A**= automatic with float **NA**= non automatic without float

# DIVER 6

## SUBMERSIBLE MULTI-IMPELLER PUMPS

**NEW**

6" multi-impeller submersible pump for clean water, designed for pressurization, rainwater re-use, gardening and irrigation in residential building service.

The pump is ideal for use in rainwater recovery systems and to increase the water pressure.

Available as manual or automatic model. The automatic version is a single-phase pump with a float switch for protection against dry running. It does not require a control panel with the starting capacitor and the motor with integrated overheating protection. Equipped with stainless steel debris filter, a non-return valve and a 15 meter power cable with power plug. Renewed to further increase reliability and the ergonomics (the handle has been completely redesigned).

The pumps is supplied as standard with a four-section outlet fitting-reducer.

**Flow rate maximum**

From 1 m<sup>3</sup>/h to 5,4 m<sup>3</sup>/h

**Head up to** 46 m

**Maximum immersion depth** 12 m

**Type of pumped liquid** Clean, free from solid or abrasive substances, non-viscous, non-aggressive, non-crystallized and chemically neutral

**Minimum and maximum ambient temperature** 0°C / +35°C

**Maximum number of starts** 20/h

**Impeller/s material** Technopolymer

**Power cable (m) and plug** 15 m H07RNF with power plug

**Possible type of installation** Fixed or portable in vertical position

**Special versions on request**

Cables of different lengths, different plugs

MODEL	CODE	ELECTRICAL DATA					HYDRAULIC DATA										Ø	WEIGHT KG	Q.TY x PALLET
		VOLTAGE 50 Hz	P1 kW	P2		In A	Q=m <sup>3</sup> /h	0	0,9	1,8	2,7	3,6	4,5	5,1	5,4	H (m)			
				kW	HP		Q=l/min	0	15	30	45	60	75	85	90				
<b>DIVER 6 600 M-A</b>	60190331.	1x230 V~	0,55	0,35	0,50	3	H (m)	24	22	19,5	16,2	12,5	7,5	3,7	1,5	1"	8,0	40	
<b>DIVER 6 700 M-A</b>	60188189.	1x230 V~	0,90	0,65	0,88	3,8		36	32,6	28,5	23,6	17	9,5	4,6	1,8	1"	9,3	40	
<b>DIVER 6 800 M-A</b>	60189184.	1x230 V~	1,10	0,75	1	4,8		46	41	35,5	29,2	21,8	13,5	7,8	3,5	1"	9,4	40	
<b>DIVER 6 600 M-NA</b>	60193002.	1x230 V~	0,55	0,35	0,50	3		24	22	19,5	16,2	12,5	7,5	3,7	1,5	1"	8,0	40	
<b>DIVER 6 700 M-NA</b>	60193003.	1x230 V~	0,90	0,65	0,88	3,8		36	32,6	28,5	23,6	17	9,5	4,6	1,8	1"	9,3	40	

# DIVERTRON

ELECTRONIC MULTISTAGE SUBMERSIBLE PUMPS



DIVERTRON



DIVERTRON X

Submersible multistage pumps with built-in integrated electronics, designed to automatically start and stop the pump.  
Built-in electronic board, pressure switch and flow sensor.  
Equipped with dry-run protection.  
Built-in non return valve.  
Easy to use.  
High reliability.  
Available with 3 or 4 impellers  
Supplied with 15 m power cord.  
Available with screen filter or stainless steel ring for use of suction kit.

**Installation recommended with auxiliary tank.**



**Operating range** from 1 to 5,4 m<sup>3</sup>/h with head up to 46 metres.

**Pumped liquid** clean, free of solids and abrasives, non-aggressive.

**Liquid temperature range** from 0 °C to +35 °C.

**Max. immersion depth** 12 metres.

**Motor protection class** IP 68.

**Motor protection rating** F.

**Installation** fixed or portable, vertical position.

**Operation** Manual or automatic with electronic ON/OFF (continuous duty with totally submerged pump).

**Discharge port diameter** 1".

**Pump maximum diameter** 150 mm.

ACCESSORIES  
PAG. 319

MODEL	CODE	ELECTRICAL DATA			HYDRAULIC DATA									Ø	CABLE LENGTH M.
		VOLTAGE 50 Hz	P2 NOMINAL		Q m <sup>3</sup> /h l/min	0	0,9	1,8	2,7	3,6	4,5	5,1	5,4		
	kW		HP	H (m)		0	15	30	45	60	75	85	90		
<b>DIVERTRON 1000 M</b>	60122623	1 x 230 V	0,55		0,75	36	32,6	28,5	23,6	17	9,5	4,6	1,8	1"	15
<b>DIVERTRON X 1000 M</b>	60122625	1 x 230 V	0,55		0,75	36	32,6	28,5	23,6	17	9,5	4,6	1,8	1"	15
<b>DIVERTRON 1200 M</b>	60122626	1 x 230 V	0,75		1	46	41	35,5	29,2	21,8	13,5	7,8	3,5	1"	15
<b>DIVERTRON X 1200 M</b>	60122627	1 x 230 V	0,75	1	46	41	35,5	29,2	21,8	13,5	7,8	3,5	1"	15	

## KIT DIVERTRON X

MODEL	CODE
<b>DIVERTRON 1000 X + 1 M SUCTION KIT</b>	60165968
<b>DIVERTRON 1200 X + 1 M SUCTION KIT</b>	60165972



# ANOTHER STEP FORWARD!

# DTRON

7" ELECTRONIC MULTISTAGE SUBMERSIBLE PUMPS

**NEW RANGE**



WATER BOOSTING



RAIN WATER  
REUSE



GARDENING &  
IRRIGATION



GROUND WATER



[DTRON.DABPUMPS.COM](http://DTRON.DABPUMPS.COM)

**DAB**<sup>®</sup>  
WATER • TECHNOLOGY

# DTRON 2

7" ELECTRONIC MULTISTAGE SUBMERSIBLE PUMPS



**NEW**



7" submersible electronic multi-impeller pump designed for use in water wells, tanks or cisterns. The pump is suitable for use in residential building service for pressurization, rainwater reuse and gardening and irrigation.

The pressure switch and flow switch integrated with the electronic board, make the pump completely automatic for the switching on/off and dry running protection. It integrates a double mechanical seal, a non return valve and a handle for ease transport and installation. Built with an innovative modular design: the hydraulic part, the motor, the electrical part and the filter can be disassembled separately, simplifying the maintenance activity.

The suction height is adjustable from the bottom up to 8 cm using the special accessory supplied as standard. A float can be connected without compromising the water tightness of the pump thanks to the NFC pocket. The integrated expansion vessel protect from water hammer, an additional expansion vessel is not required. The cable has a quick coupling for easier installation inside the tank/cistern.

The pump is also available in X version with 1" intake and kit X which includes 1 meter suction hose and float to prevent the suction of impurities from the bottom. The whole pump is classified as IP 68. With the accessory DOC68 (supplied separately) becomes a surface pump to be used under the water level.

\* Certified version for drinking water is available on request.

**Flow rate maximum** 7,2 m<sup>3</sup>/h

**Head up to** 45 m

**Maximum immersion depth** 12 m

**Type of pumped liquid** Clean, free from solid or abrasive substances, non-viscous, non-aggressive, non-crystallized and chemically neutral

**Free passage** 2 mm

**Liquid temperature range from** +0°C to +50°C

**Maximum immersion depth** 15 m

**Set cut-in** 2,4 bar (+-0,2)

**Outlet connection** Thread 1" 1/4

**Pump maximum diameter** 185 mm

**Protection class** IP 68

**Motor insulation class** F

**Power cable (m) and plug** 15 m with plug

**Possible type of installation** Fixed, horizontal or vertical. Submerged or semi-submerged. It can be installed on the surface, under the water level, or outside in a vertical position with the DOC68 accessory (supplied separately).

## DTRON 2



ACCESSORIES  
PAG. 319

MODEL	CODE	ELECTRICAL DATA					HYDRAULIC DATA														WEIGHT KG	Q.TY x PALLET						
		VOLTAGE 50 Hz	P2		In A	Q=m <sup>3</sup> h	0	0,7	1,2	1,8	2,4	3	3,6	4,2	4,8	5,4	6	6,3	6,6	7,3			7,5					
			P1 kW	kW			HP	Q=l/min	0	11	20	30	40	50	60	70	80	90	100	105			110	122	125			
DTRON2 35/90	60195238	1x220-240V ~	0,75	0,52	0,7	3,4	H (m)	37,0	35,9	35,0	33,0	30,0	26,7	22,7	18,5	13,4	7,6	0,6									11,4	15
DTRON2 45/90	60188290	1x220-240V ~	0,93	0,6	0,8	4,2		45,0	43,0	41,2	38,0	34,2	29,7	24,7	20,0	15,0	9,0	2,5	0,6								11,4	15
DTRON2 35/120	60195251	1x220-240V ~	0,9	0,6	0,8	4		38,0	37,6	36,3	34,0	31,5	28,9	26,0	23,2	20,0	16,3	12,0	9,8	7,5	2,2	0,7				11,4	15	

## X VERSION

MODEL	CODE
DTRON2 X 35/90	60195250
DTRON2 X 45/90	60195236
DTRON2 X 35/120	60195257
DTRON2 X 35/90 + 1m SUCTION KIT	60196488
DTRON2 X 45/90 + 1m SUCTION KIT	60196489
DTRON2 X 35/120 + 1m SUCTION KIT	60196490



DTRON 2  
DIMENSIONS  
ø 18,5 x 61 cm

The photo is purely indicative, the accessory is supplied unassembled.

discover **DTRON**  
<https://dtron.dabpumps.com>



# DTRON 3

7" ELECTRONIC MULTISTAGE SUBMERSIBLE PUMPS



**NEW**



7" electronic submersible multi-impeller pump for clean water designed for use in wells, cisterns or tanks. It can be used submerged, partially submerged or on the surface (with the appropriate accessory).

It is suitable for use in residential building service for pressurization, reuse of rainwater and gardening and irrigation activities.

The pressure sensor and a flow meter integrated with the electronic board, make the pump completely automatic for the switching on/off and dry running protection. It integrates a double mechanical seal, a non return valve and a handle for ease transport and installation. Suction height can be adjusted from the bottom up to 8 cm using the special accessory supplied as standard. It is possible to connect a float without compromising the watertight seal of the pump thanks to the NFC (Near Field Communication) pocket.

The starting pressure is adjustable through the Com Box, supplied as standard. Expansion vessel included, use of an additional expansion vessel is superfluous. 15 meter power cable with plug. The Com Box allows you to set the start and stop pressure and to control the alarms.

Pump available in the X version with 1" inlet and X kit which includes the 1 meter suction tube and float to prevent the suction of impurities from the bottom.

The entire pump is IP 68 certified. With the DOC68 accessory (supplied separately) it becomes an IP 68 surface pump to be used under head. If the pump is combined with an identical DTRON 3 the two pumps can operate in twin or alternate mode.

\* Certified version for drinking water available on request.

**Flow rate maximum** 7,2 m<sup>3</sup>/h

**Head up to** 45 m

**Maximum immersion depth** 12 m

**Type of pumped liquid** Clean, free from solid or abrasive substances, non-viscous, non-aggressive, non-crystallized and chemically neutral

**Free passage** 2 mm

**Liquid temperature range from** +0°C to +50°C

**Maximum immersion depth** 15 m

**Set cut-in** 2,4 bar (+/-0,2)

**Outlet connection** Thread 1" 1/4

**Pump maximum diameter** 185 mm

**Protection class** IP 68

**Motor insulation class** F

**Power cable (m) and plug** 15 m with plug

**Possible type of installation** Fixed, horizontal or vertical. Submerged or semi-submerged. It can be installed on the surface, under the water level, or outside in a vertical position with the DOC68 accessory (supplied separately).

## DTRON 3



ACCESSORIES  
PAG. 319

MODEL	CODE	ELECTRICAL DATA				HYDRAULIC DATA																	WEIGHT KG	Q.TY x PALLET				
		VOLTAGE 50 Hz	P1 kW	P2		In A	Q=m <sup>3</sup> /h Q=l/min	H (m)																				
				kW	HP			0	0,7	1,2	1,8	2,4	3	3,6	4,2	4,8	5,4	6	6,3	6,6	7,3	7,5						
DTRON3 35/90	60195016	1 x 220-240 V ~	0,75	0,52	0,7	3,4		37,0	35,9	35,0	33,0	30,0	26,7	22,7	18,5	13,4	7,6	0,6									11,6	15
DTRON3 45/90	60188287	1 x 220-240 V ~	0,93	0,6	0,8	4,2		45,0	43,0	41,2	38,0	34,2	29,7	24,7	20,0	15,0	9,0	2,5	0,6								11,6	15
DTRON3 35/120	60195034	1 x 220-240 V ~	0,9	0,6	0,8	4		38,0	37,6	36,3	34,0	31,5	28,9	26,0	23,2	20,0	16,3	12,0	9,8	7,5	2,2	0,7				11,6	15	

## X VERSION

MODEL	CODE
DTRON3 X 35/90	60195012
DTRON3 X 45/90	60194987
DTRON3 X 35/120	60195032
DTRON3 X 35/90 + 1m SUCTION KIT	60196491
DTRON3 X 45/90 + 1m SUCTION KIT	60196492
DTRON3 X 35/120 + 1m SUCTION KIT	60196493



DTRON 3  
DIMENSIONS  
ø 18,5 x 65 cm

The photo is purely indicative, the accessory is supplied unassembled.

discover **DTRON**  
<https://dtron.dabpumps.com>



# ESYBOX DIVER

7" MULTISTAGE SUBMERSIBLE PUMPS WITH VARIABLE FREQUENCY DRIVE



**NEW**



7" multi-stage electronic pump with variable frequency drive for clean water designed for use in wells, tanks or cisterns.

The pump can be used submerged, partially submerged or on the surface (with the DOC68 accessory, supplied separately).

The pump is suitable for pressurization, rainwater re-use and gardening and irrigation activities in residential building service. The pump integrates the variable frequency drive for operation according to the system requirements a non-return valve and a handle in stainless steel for transport. The electronic operation also protects against dry running and the VFD saves energy. The suction height is adjustable from the bottom up to 8 cm. It is possible to connect a float and a level sensor without compromising the water tightness of the pump thanks to the NFC (Near Field Communication) pocket. Equipped with expansion tank making the use of an additional expansion tank superfluous.

Wi-Fi connectivity as standard. The DConnect Box 2 is included, by downloading the DConnect app for Android or iOS you can control the pump from your smartphone.

The pump is available in X version with 1" inlet and X kit which includes 1 meter suction hose and float to prevent the suction of impurities from the bottom. The whole pump is IP 68 certified, it can be used on the surface (under head).

If combined with an identical pump, two pumps can operate in alternate or simultaneous mode.

**Flow rate maximum** 7,2 m<sup>3</sup>/h

**Head up to** 55 m

**Maximum immersion depth**  
12 m standard version

**Type of pumped liquid** Clean, free from solid or abrasive substances, non-viscous, non-aggressive, non-crystallized and chemically neutral

**Free passage** 2 mm

**Liquid temperature range from**  
+0°C to +50°C

**Maximum immersion depth** 15 m

**Set cut-in** 2,4 bar (+-0,2)

**Outlet connection** Thread 1" 1/4

**Pump maximum diameter** 185 mm

**Protection class** IP 68

**Motor insulation class** F

**Power cable (m) and plug** 15 m with plug

**Possible type of installation** Fixed, horizontal or vertical. Submerged or semi-submerged. It can be installed on the surface, under the water level, or outside in a vertical position with the DOC68 accessory (supplied separately).

## esybox DIVER

**D+CONNECT**

PAG. 5

ACCESSORIES  
PAG. 319

MODEL	CODE	ELECTRICAL DATA					HYDRAULIC DATA													WEIGHT KG	Q.TY x PALLET	
		VOLTAGE 50 Hz	P1 MAX kW	P2 NOMINAL kW	HP	In A	Q=m <sup>3</sup> /h	0	0,6	1,2	1,8	2,4	3,0	3,6	4,2	4,8	5,4	6	6,6			7,2
ESYBOX DIVER	60188296	1 x 220-240 V ~	1,3	0,95	1,3	5,5	Q=l/min	0	10	20	30	40	50	60	70	80	90	100	110	120	17	15

### APPLICATIONS



### Esybox Diver

Houses and small residential buildings up to 6 floors and a maximum of 9 apartments.\*

\*Indicative data. Please refer to the technical catalogue or DNA for correct sizing.

### CERTIFICATIONS are pending approval



### SUITABLE FOR PUMPING WATER FROM:



TANKS



RAINWATER  
COLLECTION TANKS



WELLS DOWN  
TO 8 M DEEP

## X VERSION

MODEL	CODE
ESYBOX DIVER X	60195078
ESYBOX DIVER X + 1m SUCTION KIT	60196494

The photo is purely indicative, the accessory is supplied unassembled.



ESYBOX DIVER  
DIMENSIONS  
ø 18,5 x 65 cm



# MICRA HS

## HIGH SPEED 3" SUBMERSIBLE PUMPS



3" submersible pump for pressurization, gardening, irrigation and subsurface water removal tasks in residential building service.

It can be installed in wells of at least 3" or in cisterns and tanks; Micra HS makes it possible to increase the pressure of the water trapped and to use it to water the garden or the vegetable garden.

Micra HS is supplied with the Active Driver Plus variable frequency drive, which allows the pump motor speed to be adjusted according to requirements, thus allowing energy savings and increasing the maximum motor rotation speed (up to 130 Hz or 7600 rpm) to allow better performance compared to pumps of the same size.

Pump and motor coupled by rigid joint. Non-return valve integrated in the cylinder head. Two-pole asynchronous submersible electric motor with stator immersed in thermosetting insulating resin, with high heat dissipation capacity and encapsulated in a hermetic stainless steel casing.

The DConnect service makes remote control possible (with DConnect Box supplied separately).

### Power supply tolerance

230 V (+10% / -20%) single-phase

**Rotation speed** 7.600 rpm (130 Hz)

**Pump voltage** 230 V three-phase

### Operating range

from 1 to 5 m<sup>3</sup>/h with head up to 150 m

**Pumped liquid** clean, free of solid or abrasive contaminants, non-viscous, non-aggressive, chemically neutral, similar to water properties  
Maximum permissible sand quantity: 50 g/m<sup>3</sup>  
Liquid temperature range: from 0°C up to +35°C  
Installation: boreholes ≥ 3" diameter and tanks in vertical position. In case of horizontal installation, ensure a minimum load applied to the thrust bearings

**Power lead cable** 1,4 m or 60 m removable cable (available also as optional single unit shielded cable 30m, 60m, 90m long)

**The package contains the pump (hydraulic part and motor) with standard cable and Active Driver.**

PAG. 5

AD PLUS  
PAG. 25

ACCESSORIES  
PAG. 319

MODEL	1,4 METERS CABLE CODE	60 METERS CABLE CODE	ELECTRICAL DATA		Q m <sup>3</sup> /h l/min	HYDRAULIC DATA (n ~ 6300 1/min)										DNM GAS			
			VOLTAGE 50 Hz	P1 MAX kW		0,5	1	1,5	2	2,5	3	3,5	4	4,5	5				
MICRA HS 2/5	60180974	60192436	1x230 V ~	1,1	H (m)	80	68	55	40	24								1"	
MICRA HS 2/7	60180975	60192437	1x230 V ~	1,4		105	90	73	55	32									1"
MICRA HS 2/9	60180976	60192438	1x230 V ~	1,7		128	108	87	62	38									1"
MICRA HS 2/11	60180977	60192439	1x230 V ~	2,0		150	130	102	75	45									1"
MICRA HS 3/2	60180978	60192440	1x230 V ~	1,0				40	37	33	29	24	20						1"
MICRA HS 3/3	60180979	60192441	1x230 V ~	1,3					52	48	43	38	34	28					1"
MICRA HS 3/4	60180980	60192442	1x230 V ~	1,6					65	61	56	50	44	36					1"
MICRA HS 3/5	60180981	60192443	1x230 V ~	1,9					78	74	68	61	54	45					1"
MICRA HS 4/3	60180982	60192444	1x230 V ~	1,6							50	46	42	39	35	29			1"
MICRA HS 4/4	60180983	60192445	1x230 V ~	1,9							63	59	55	49	43	34			1"

# MICRA

## 3" SUBMERSIBLE PUMPS

**CB<sup>(1)</sup>**

**BOOSTER**

Centrifugal type. Directly coupled pump and motor with rigid coupling. Impellers and thrust rings in Noryl and diffusers in self-lubricating polyacetyl. Pump liner, shaft and coupling, strainer and cable sheath in stainless steel. Base support and head in brass with check valve incorporated in head. Submersible asynchronous two-pole motor made entirely of AISI 304 stainless steel with brass bearings. Squirrel cage rotor in copper mounted on Kingsbury thrust block. Cooling of the thrust bearing assembly and the bushings is provided by water, thereby eliminating the risk of oil contamination. **Stainless steel canned stator, filled with thermosetting resin with high insulation property and better thermal dissipation capability.**

The automatic reset thermal protection device is integral with the motor.

**Liquid quality requirements** clean, free of solid or abrasive contaminants, non-viscous, chemically neutral, close to the properties of water.

**Liquid temperature range** da 0° C a +35° C

**Maximum permissible sand quantity** 40 g/m<sup>3</sup>

**Protection rating** IP 68

**Heat insulation class** F

**Max. no. of starts** 20/h

**Power cable**

MICRA 50 - 1 m.

MICRA 75 - 1,2 m.

MICRA 100 - 1,4 m.

Ready-to-install kit available including single phase electric pump with 15m cable and double capacitor control panel.

<sup>(1)</sup>Required for single-phase versions

ACCESSORIES  
PAG. 319

MODEL	CODE	ELECTRICAL DATA						DNM GAS	WEIGHT KG	HYDRAULIC DATA (n _ 2800 1/min)									
		VOLTAGE 50 Hz	P1 MAX kW	P2 NOMINAL		In A	H (m)			Q m <sup>3</sup> /h l/min	0,3	0,6	0,9	1,2	1,5	1,8	2,1	2,4	2,7
				kW	HP						5	10	15	20	25	30	35	40	45
MICRA 50 M	0090114	1x230V ~	0,65	0,37	0,5	3,3	1*	9	45	41	38	35	31	27	21	14	6		
MICRA 75 M	0090418	1x230V ~	0,95	0,55	0,75	5,1	1*	10,2	68	64	59	54	48	42	33	23	11		
MICRA 75 T	0090618	3x400V ~	0,9	0,55	0,75	1,9	1*	10,2	68	64	59	54	48	42	33	23	11		
MICRA 100 M	0090817	1x230V ~	1,2	0,75	1	6,1	1*	13,6	90	84	78	72	65	56	44	30	14		
MICRA 100 T	0090944	3x400V ~	1,15	0,75	1	2,4	1*	13,6	90	84	78	72	65	56	44	30	14		
MICRA 50 M + 15 mt. CABLE + Control Box Booster*	0090116	1x230V ~	0,65	0,37	0,5	3,3	1*	12,7	45	41	38	35	31	27	21	14	6		
MICRA 75 M + 15 mt. CABLE + Control Box Booster*	0090419	1x230V ~	0,95	0,55	0,75	5,1	1*	14,1	68	64	59	54	48	42	33	23	11		
MICRA 100 M + 15 mt. CABLE + Control Box Booster*	0090818	1x230V ~	1,2	0,75	1	6,1	1*	16,4	90	84	78	72	65	56	44	30	14		

\* Double capacitor booster control panel to optimize the starting torque

# S4 AMEIRA - WATER FILLED MOTOR

4" SUBMERSIBLE PUMPS



The S4 AMEIRA are a 4 inches multi-impeller borehole pumps for clean water, designed for water boosting, gardening and irrigation, lifting water from boreholes in domestic and residential, civil and commercial applications and irrigation systems also for agriculture.

Hydraulic part and motor made of AISI 304 stainless steel and technopolymer for parts in contact with water. Technopolymer impellers and diffusers. Built-in non-return valve and suction filter. Single-phase version with manually resettable overload protection and capacitor in the electric control panel to be ordered separately (except for the kit version). Overload protection to be provided by the user for the three-phase version.

**Water filled motor, stainless steel cased stator, filled with thermosetting resin with high insulation property and better thermal dissipation capability.**

Available: only pump body, pump body with water or oil-filled motor and kit with pump body and motor, power supply cable, cord and control box.

All the model have the ACS and WRAS certificates. DM174 certificate are pending approval.

**Flow rate** up to 21,6 m<sup>3</sup>/h

**Head up to** 427 m

**Type of pumped liquid** clean, free of solids and abrasive substances, non-viscous, non-aggressive, non-crystallized and chemically neutral

**Pump maximum diameter** 99 mm

**Maximum amount of sand** 150 g/m<sup>3</sup>

**Impellers material**  
Technopolymer

**Liquid temperature range**  
From 0°C to + 40°C

**Max immersion depth**  
4GG: 300 m

**Motor protection class** IP 68

**Motor insulation class** F



DM 174

certificate pending approval

SAND RESISTANT

MODEL	P2 NOMINAL		DNM	VOLTAGE 1x230 ~ V					VOLTAGE 3x400 ~ V			VOLTAGE 3x230 ~ V				
	KW	HP		CODE	In A	WEIG. (Kg)	CONTROL BOX CODE	KIT WITH: pump, 4GG motor, power supply cable, control box and cord		CODE	In A	WEIG. (Kg)	CODE	In A	WEIG. (Kg)	
								KIT CODE	CABLE LENGTH							WEIG. (Kg)
S4 1/13	0,37	0,5	1" ¼	60190949	3,3	10,6	108003210	60191458	15	14,7	60191135	1,6	9,9	60190986	2,7	9,9
S4 1/19	0,55	0,75	1" ¼	60190950	4,6	13,3	108003220	60191459	30	19,8	60191136	1,9	11,6	60190987	3,3	11,6
S4 1/26	0,75	1	1" ¼	60190951	6,2	15,2	108003270	60191460	30	21,7	60191137	2,4	14,2	60190988	4,1	14,2
S4 1/37	1,1	1,5	1" ¼	60190952	8,6	19,1	108003280	60191461	40	27,8	60191138	3,2	16,9	60190989	5,5	16,9
S4 1/48	1,5	2	1" ¼	60190953	11	22,7	108003290	60191462 **	40	31,4	60191139	4,4	20,5	60190990	7,6	20,5
S4 2/7	0,37	0,5	1" ¼	60190954	3,3	9,9	108003210	60191463	15	14,0	60191141	1,6	9,2	60190991	2,7	9,2
S4 2/10	0,55	0,75	1" ¼	60190955	4,6	12,1	108003220	60191464	15	16,2	60191142	1,9	10,4	60190992	3,3	10,4
S4 2/14	0,75	1	1" ¼	60190956	6,2	13,6	108003270	60191465	30	20,1	60191143	2,4	12,6	60190993	4,1	12,6
S4 2/20	1,1	1,5	1" ¼	60190957	8,6	16,7	108003280	60191466	40	25,4	60191144	3,2	14,5	60190994	5,5	14,5
S4 2/28	1,5	2	1" ¼	60190958	11	20,6	108003290	60191467	40	29,3	60191145	4,4	18,4	60190995	7,6	18,4
S4 2/40	2,2	3	1" ¼	60190959	15	24	108003300	60191468 **	40	32,7	60191146	5,9	23,3	60190996	10,2	23,3
S4 2/52	3	4	1" ¼								60191147	8,3	31,9	60190997	14,3	31,9
S4 3/6	0,37	0,5	1" ¼	60190960	3,3	10,1	108003210	60191469	15	14,2	60191148	1,6	9,4	60190998	2,7	9,4
S4 3/9	0,55	0,75	1" ¼	60190961	4,6	12,3	108003220	60191470	15	16,4	60191149	1,9	10,6	60190999	3,3	10,6
S4 3/13	0,75	1	1" ¼	60190962	6,2	13,8	108003270	60191471	30	20,3	60191150	2,4	12,8	60191000	4,1	12,8
S4 3/19	1,1	1,5	1" ¼	60190963	8,6	17,3	108003280	60191472	40	26,0	60191151	3,2	15,1	60191004	5,5	15,1
S4 3/25	1,5	2	1" ¼	60190964	11	20,2	108003290	60191473	40	28,9	60191152	4,4	18	60191005	7,6	18
S4 3/32	2,2	3	1" ¼	60192298	15	22,4	108003300	60192306 **	40	31,1	60192302	5,9	19,5	60192299	10,2	19,5
S4 3/39	2,2	3	1" ¼	60190965	15	24,5	108003300	60191474 **	40	33,2	60191153	5,9	23,8	60191006	10,2	23,8
S4 3/45	3	4	1" ¼								60192303	8,3	31,6	60192300	14,3	31,6
S4 3/51	3	4	1" ¼								60191154	8,3	32,9	60191007	14,3	32,9
S4 3/67	4	5,5	1" ¼								60191155	10	63	60191008	17,3	63

\*\* Motor and pump are disassembled in the same package in the Kit version

\* Control box not included

D+CONNECT  
COMMAND AND CONTROL SYSTEMS  
CIRCULATORS AND IN-LINE PUMPS  
MULTISTAGE CENTRIFUGAL AND SELF-PRIMING PUMPS  
SWIMMING POOL, POND AND SALT WATER PUMPS  
CENTRIFUGAL PUMPS  
SUBMERSIBLE PUMPS  
SUBMERSIBLE PUMPS AND SUBMERSIBLE MOTORS  
PRESSURE UNITS

# S4 AMEIRA - WATER FILLED MOTOR

4" SUBMERSIBLE PUMPS



MODEL	P2 NOMINAL		DNM	VOLTAGE 1x230 ~ V							VOLTAGE 3x400 ~ V			VOLTAGE 3x230 ~ V		
	KW	HP		CODE	In A	WEIG. (Kg)	CONTROL BOX CODE	KIT WITH: pump, 4GG motor, power supply cable, control box and cord			CODE	In A	WEIG. (Kg)	CODE	In A	WEIG. (Kg)
								KIT CODE	CABLE LENGTH	WEIG. (Kg)						
S4 4/4	0,37	0,5	1" ¼	60190966	3,3	9,6	108003210	60191475	15	13,7	60191156	1,6	8,9	60191009	2,7	8,9
S4 4/7	0,55	0,75	1" ¼	60190967	4,6	11,8	108003220	60191476	15	15,9	60191157	1,9	10,1	60191010	3,3	10,1
S4 4/9	0,75	1	1" ¼	60190968	6,2	13,2	108003270	60191477	15	17,3	60191158	2,4	12,2	60191011	4,1	12,2
S4 4/14	1,1	1,5	1" ¼	60190969	8,6	16,3	108003280	60191478	30	22,8	60191159	3,2	14,1	60191012	5,5	14,1
S4 4/19	1,5	2	1" ¼	60190970	11	19,8	108003290	60191479	40	28,5	60191160	4,4	17,6	60191013	7,6	17,6
S4 4/27	2,2	3	1" ¼	60190971	15	22,3	108003300	60191480	40	31,0	60191161	5,9	21,6	60191014	10,2	21,6
S4 4/35	3	4	1" ¼								60191162	8,3	29,7	60191015	14,3	29,7
S4 4/48	4	5,5	1" ¼								60191163	10	35,6	60191016	17,3	35,6
S4 4/62	5,5	7,5	1" ¼								60191164	14	41,5	60191017	24,2	41,5
S4 6/5	0,55	0,75	1" ¼	60190972	4,6	11,8	108003220	60191481	15	15,9	60191165	1,9	10,1	60191018	3,3	10,1
S4 6/7	0,75	1	1" ¼	60190973	6,2	13,2	108003270	60191482	15	17,3	60191166	2,4	12,2	60191021	4,1	12,2
S4 6/10	1,1	1,5	1" ¼	60190974	8,6	16,1	108003280	60191483	15	20,2	60191167	3,2	13,9	60191022	5,5	13,9
S4 6/14	1,5	2	1" ¼	60190975	11	19,1	108003290	60191484	30	25,6	60191168	4,4	16,9	60191023	7,6	16,9
S4 6/21	2,2	3	1" ¼	60190976	15	22,5	108003300	60191485**	30	29,0	60191169	5,9	21,8	60191024	10,2	21,8
S4 6/29	3	4	1" ¼								60191170	8,3	30,4	60191025	14,3	30,4
S4 6/38	4	5,5	1" ¼								60191172	10	36,1	60191026	17,3	36,1
S4 6/52	5,5	7,5	1" ¼								60191173	14	66,6	60191027	24,2	66,6
S4 6/61	7,5	10	1" ¼								60192304	17,4	75	60192301	30,1	75
S4 8/5	0,75	1	2"	60190977	6,2	13,4	108003270	60191486	15	17,5	60191174	2,4	12,4	60191028	4,1	12,4
S4 8/7	1,1	1,5	2"	60190978	8,6	16,3	108003280	60191487	15	20,4	60191175	3,2	14,1	60191029	5,5	14,1
S4 8/9	1,5	2	2"	60190979	11	19,1	108003290	60191488	15	23,2	60191176	4,4	16,9	60191030	7,6	16,9
S4 8/15	2,2	3	2"	60190980	15	21,9	108003300	60191489**	30	28,4	60191177	5,9	21,2	60191041	10,2	21,2
S4 8/21	3	4	2"								60191178	8,3	29,5	60191042	14,3	29,5
S4 8/27	4	5,5	2"								60191179	10	36,2	60191043	17,3	36,2
S4 8/35	5,5	7,5	2"								60192320	14	41,8	60192336	24,2	41,8
S4 8/38	5,5	7,5	2"								60191180	14	66,6	60191044	24,2	66,6
S4 8/47	7,5	10	2"								60192321	17,4	74,8	60192319	30,1	74,8
S4 8/50	7,5	10	2"								60191181	17,4	78,2	60191045	30,1	78,2
S4 12/6	1,1	1,5	2"	60190981	8,6	16,3	108003280	60191490	15	20,4	60191185	3,2	14,1	60191046	5,5	14,1
S4 12/9	1,5	2	2"	60190982	11	19,8	108003290	60191491	15	23,9	60191186	4,4	17,6	60191047	7,6	17,6
S4 12/13	2,2	3	2"	60190983	15	21,7	108003300	60191492**	15	25,8	60191187	5,9	21	60191048	10,2	21
S4 12/18	3	4	2"								60191188	8,3	31	60191049	14,3	31
S4 12/24	4	5,5	2"								60191189	10	35,9	60191050	17,3	35,9
S4 12/34	5,5	7,5	2"								60191190	14	67,9	60191051	24,2	67,9
S4 12/44	7,5	10	2"								60191191	17,4	78,8	60191052	30,1	78,8
S4 16/8	1,5	2	2"	60190984	11	20	108003290	60191493	15	24,1	60191192	4,4	17,8	60191053	7,6	17,8
S4 16/12	2,2	3	2"	60190985	15	23,2	108003300	60191494**	15	27,3	60191193	5,9	22,5	60191054	10,2	22,5
S4 16/16	3	4	2"								60191194	8,3	32	60191055	14,3	32
S4 16/21	4	5,5	2"								60191195	10	38,5	60191056	17,3	38,5
S4 16/29	5,5	7,5	2"								60191196	14	71,1	60191057	24,2	71,1
S4 16/38	7,5	10	2"								60191197	17,4	85,8	60191058	30,1	85,8

\*\* Motor and pump are disassembled in the same package in the Kit version

\* Control box not included

# S4 AMEIRA - OIL FILLED MOTOR

4" SUBMERSIBLE PUMPS



The S4 AMEIRA are a 4 inches multi-impeller borehole pumps for clean water, designed for water boosting, gardening and irrigation, lifting water from boreholes in domestic and residential, civil and commercial applications and irrigation systems also for agriculture.

Hydraulic part and motor made of AISI 304 stainless steel and technopolymer for parts in contact with water. Technopolymer impellers and diffusers. Built-in non-return valve and suction filter. Single-phase version with manually resettable overload protection and capacitor in the electric control panel to be ordered separately (except for the kit version). Overload protection to be provided by the user for the three-phase version.

### Oil filled motor, rewindable stator.

Available: only pump body, pump body with water or oil-filled motor and kit with pump body and motor, power supply cable, cord and control box.

All the model have the ACS and WRAS certificates. DM174 certificate are pending approval.

**Flow rate** up to 21,6 m<sup>3</sup>/h

**Head up to** 427 m

**Type of pumped liquid** clean, free of solids and abrasive substances, non-viscous, non-aggressive, non-crystallized and chemically neutral

**Pump maximum diameter** 99 mm

**Maximum amount of sand** 150 g/m<sup>3</sup>

**Impellers material**

Technopolymer

**Liquid temperature range**

From 0°C to + 40°C

**Max immersion depth**

40L: 250 m

**Motor protection class** IP 68

**Motor insulation class** F



DM 174

certificate pending approval

SAND RESISTANT

MODEL	P2 NOMINAL		DNM	VOLTAGE 1x230 ~ V					VOLTAGE 3x400 ~ V			VOLTAGE 3x230 ~ V				
	kW	HP		CODE	In A	WEIG. (Kg)	CONTROL BOX CODE	KIT WITH: pump, 40L motor, power supply cable, control box and cord		CODE	In A	WEIG. (Kg)	CODE	In A	WEIG. (Kg)	
								KIT CODE	CABLE LENGTH							WEIG. (Kg)
S4 1/13	0,37	0,5	1" ¼	60190751	3,5	10,2	108003210	60191402	15	14,3	60190851	1,2	10,2	60190788	2,1	10,2
S4 1/19	0,55	0,75	1" ¼	60190752	4,5	12,1	108003220	60191403	30	18,6	60190852	2,2	11,2	60190789	3,8	11,2
S4 1/26	0,75	1	1" ¼	60190753	6,3	14,3	108003270	60191404	30	20,8	60190853	2,6	13	60190790	4,5	13
S4 1/37	1,1	1,5	1" ¼	60190754	8,5	17	108003280	60191405	40	25,7	60190854	3,6	16	60190791	6,2	16
S4 1/48	1,5	2	1" ¼	60190755	10,8	20,4	108003290	60191406 **	40	29,1	60190855	4,6	18,4	60190792	7,9	18,4
S4 2/7	0,37	0,5	1" ¼	60190756	3,5	9,5	108003210	60191407	15	13,6	60190858	1,2	9,5	60190795	2,1	9,5
S4 2/10	0,55	0,75	1" ¼	60190757	4,5	10,9	108003220	60191408	15	15,0	60190859	2,2	10	60190796	3,8	10
S4 2/14	0,75	1	1" ¼	60190758	6,3	12,7	108003270	60191409	30	19,2	60190860	2,6	11,4	60190797	4,5	11,4
S4 2/20	1,1	1,5	1" ¼	60190759	8,5	14,6	108003280	60191410	40	23,3	60190861	3,6	13,6	60190798	6,2	13,6
S4 2/28	1,5	2	1" ¼	60190760	10,8	18,3	108003290	60191411	40	27,0	60190862	4,6	16,3	60190799	7,9	16,3
S4 2/40	2,2	3	1" ¼	60190761	15	23,8	108003300	60191412 **	40	32,5	60190863	6	22,7	60190800	10,4	22,7
S4 2/52	3	4	1" ¼								60190864	7,5	27,3	60190801	13	27,3
S4 3/6	0,37	0,5	1" ¼	60190762	3,5	9,7	108003210	60191413	15	13,8	60190865	1,2	9,7	60190802	2,1	9,7
S4 3/9	0,55	0,75	1" ¼	60190763	4,5	11,1	108003220	60191414	15	15,2	60190866	2,2	10,2	60190803	3,8	10,2
S4 3/13	0,75	1	1" ¼	60190764	6,3	12,9	108003270	60191415	30	19,4	60190867	2,6	11,6	60190804	4,5	11,6
S4 3/19	1,1	1,5	1" ¼	60190765	8,5	15,2	108003280	60191416	40	23,9	60190873	3,6	14,2	60190805	6,2	14,2
S4 3/25	1,5	2	1" ¼	60190766	10,8	17,9	108003290	60191417	40	26,6	60190874	4,6	15,9	60190806	7,9	15,9
S4 3/32	2,2	3	1" ¼	60192291	15	22,2	108003300	60192305 **	40	30,9	60192295	6	21,1	60192292	10,4	21,1
S4 3/39	2,2	3	1" ¼	60190767	15	24,3	108003300	60191418 **	40	33,0	60190875	6	23,2	60190807	10,4	23,2
S4 3/45	3	4	1" ¼								60192296	7,5	27	60192293	13	27
S4 3/51	3	4	1" ¼								60190876	7,5	28,3	60190808	13	28,3
S4 3/67	4	5,5	1" ¼								60190877	9,6	56,3	60190809	16,6	56,3

\*\* Motor and pump are disassembled in the same package in the Kit version

\* Control box not included

# S4 AMEIRA - OIL FILLED MOTOR

4" SUBMERSIBLE PUMPS



MODEL	P2 NOMINAL		DNM	VOLTAGE 1x230 ~ V							VOLTAGE 3x400 ~ V			VOLTAGE 3x230 ~ V		
	KW	HP		CODE	In A	WEIG. (Kg)	CONTROL BOX CODE	KIT WITH: pump, 40L motor, power supply cable, control box and cord			CODE	In A	WEIG. (Kg)	CODE	In A	WEIG. (Kg)
								KIT CODE	CABLE LENGTH	WEIG. (Kg)						
S4 4/4	0,37	0,5	1" ¼	60190768	3,5	9,2	108003210	60191419	15	13,3	60190878	1,2	9,2	60190810	2,1	9,2
S4 4/7	0,55	0,75	1" ¼	60190769	4,5	10,6	108003220	60191420	15	14,7	60190879	2,2	9,7	60190811	3,8	9,7
S4 4/9	0,75	1	1" ¼	60190770	6,3	12,3	108003270	60191421	15	16,4	60190880	2,6	11	60190812	4,5	11
S4 4/14	1,1	1,5	1" ¼	60190771	8,5	14,2	108003280	60191422	30	20,7	60190881	3,6	13,2	60190813	6,2	13,2
S4 4/19	1,5	2	1" ¼	60190772	10,8	17,5	108003290	60191423	40	26,2	60190882	4,6	15,5	60190814	7,9	15,5
S4 4/27	2,2	3	1" ¼	60190773	15	22,1	108003300	60191424	40	30,8	60190883	6	21	60190815	10,4	21
S4 4/35	3	4	1" ¼								60190884	7,5	25,1	60190816	13	25,1
S4 4/48	4	5,5	1" ¼								60190885	9,6	28,9	60190817	16,6	28,9
S4 4/62	5,5	7,5	1" ¼								60190886	13,1	38,3	60190818	22,6	38,3
S4 6/5	0,55	0,75	1" ¼	60190774	4,5	10,6	108003220	60191425	15	14,7	60190887	2,2	9,7	60190819	3,8	9,7
S4 6/7	0,75	1	1" ¼	60190775	6,3	12,3	108003270	60191426	15	16,4	60190896	2,6	11	60190820	4,5	11
S4 6/10	1,1	1,5	1" ¼	60190776	8,5	14	108003280	60191427	15	18,1	60190897	3,6	13	60190821	6,2	13
S4 6/14	1,5	2	1" ¼	60190777	10,8	16,8	108003290	60191428	30	23,3	60190898	4,6	14,8	60190822	7,9	14,8
S4 6/21	2,2	3	1" ¼	60190778	15	22,3	108003300	60191429**	30	28,8	60190899	6	21,2	60190823	10,4	21,2
S4 6/29	3	4	1" ¼								60190900	7,5	25,8	60190824	13	25,8
S4 6/38	4	5,5	1" ¼								60190901	9,6	29,4	60190826	16,6	29,4
S4 6/52	5,5	7,5	1" ¼								60190902	13,1	63,4	60190827	22,6	63,4
S4 6/61	7,5	10	1" ¼								60192297	16,9	72,1	60192294	29,2	72,1
S4 8/5	0,75	1	2"	60190779	6,3	12,5	108003270	60191430	15	16,6	60190903	2,6	11,2	60190828	4,5	11,2
S4 8/7	1,1	1,5	2"	60190780	8,5	14,2	108003280	60191431	15	18,3	60190904	3,6	13,2	60190829	6,2	13,2
S4 8/9	1,5	2	2"	60190781	10,8	16,8	108003290	60191432	15	20,9	60190905	4,6	14,8	60190830	7,9	14,8
S4 8/15	2,2	3	2"	60190782	15	21,7	108003300	60191433**	30	28,2	60190906	6	20,6	60190832	10,4	20,6
S4 8/21	3	4	2"								60190907	7,5	24,9	60190833	13	24,9
S4 8/27	4	5,5	2"								60190908	9,6	29,5	60190834	16,6	29,5
S4 8/35	5,5	7,5	2"								60192317	13,1	38,6	60192315	22,6	38,6
S4 8/38	5,5	7,5	2"								60190909	13,1	63,4	60190835	22,6	63,4
S4 8/47	7,5	10	2"								60192318	16,9	71,9	60192316	29,2	71,9
S4 8/50	7,5	10	2"								60190910	16,9	75,3	60190836	29,2	75,3
S4 12/6	1,1	1,5	2"	60190783	8,5	14,2	108003280	60191434	15	18,3	60190911	3,6	13,2	60190837	6,2	13,2
S4 12/9	1,5	2	2"	60190784	10,8	17,5	108003290	60191435	15	21,6	60190912	4,6	15,5	60190838	7,9	15,5
S4 12/13	2,2	3	2"	60190785	15	21,5	108003300	60191436**	15	25,6	60190913	6	20,4	60190839	10,4	20,4
S4 12/18	3	4	2"								60190914	7,5	26,4	60190840	13	26,4
S4 12/24	4	5,5	2"								60190915	9,6	29,2	60190841	16,6	29,2
S4 12/34	5,5	7,5	2"								60190916	13,1	64,7	60190842	22,6	64,7
S4 12/44	7,5	10	2"								60190917	16,9	75,9	60190843	29,2	75,9
S4 16/8	1,5	2	2"	60190786	10,8	17,7	108003290	60191437	15	21,8	60190918	4,6	15,7	60190844	7,9	15,7
S4 16/12	2,2	3	2"	60190787	15	23	108003300	60191438**	15	27,1	60190919	6	21,9	60190845	10,4	21,9
S4 16/16	3	4	2"								60190920	7,5	27,4	60190846	13	27,4
S4 16/21	4	5,5	2"								60190921	9,6	31,8	60190847	16,6	31,8
S4 16/29	5,5	7,5	2"								60190922	13,1	67,9	60190848	22,6	67,9
S4 16/38	7,5	10	2"								60190923	16,9	82,9	60190849	29,2	82,9

\*\* Motor and pump are disassembled in the same package in the Kit version

\* Control box not included

# S4 AMEIRA

4" SUBMERSIBLE PUMPS



## ONLY PUMP END

MODEL	CODICE	ELECTRIC DATA		HYDRAULIC DATA																							H mm	DNM	WEIGHT KG
		P2 NOMINAL	Q=m³h	0	0,3	0,6	0,9	1,2	1,5	1,8	2,4	3,0	4,2	5,4	6,0	7,2	8,4	9,6	10,8	12,0	14,4	16,8	19,2	21,6					
		KW	HP	Q=l/min	0	5	10	15	20	25	30	40	50	70	90	100	120	140	160	180	200	240	280	320	360				
S4 1/13	60190691	0,37	0,5	83	78	69	56	41	22																438	1" ¼	3,7		
S4 1/19	60190692	0,55	0,75	121	111	101	82	70	45																544	1" ¼	4,7		
S4 1/26	60190693	0,75	1	173	163	148	125	98	65																667	1" ¼	5,6		
S4 1/37	60190694	1,1	1,5	236	222	196	175	130	80																897	1" ¼	7,3		
S4 1/48	60190695	1,5	2	306	289	255	225	175	100																1092	1" ¼	8,7		
S4 2/7	60190696	0,37	0,5	47	44	42	40	38	35	28	18														358	1" ¼	3,0		
S4 2/10	60190697	0,55	0,75	67	62	60	58	54	50	40	26														422	1" ¼	3,5		
S4 2/14	60190698	0,75	1	94	90	86	80	76	70	56	36														506	1" ¼	4,0		
S4 2/20	60190699	1,1	1,5	134	128	122	117	108	100	80	52														633	1" ¼	4,9		
S4 2/28	60190700	1,5	2	188	180	171	163	151	140	112	73														689	1" ¼	6,6		
S4 2/40	60190701	2,2	3	268	255	245	231	216	200	160	104														943	1" ¼	9,3		
S4 2/52	60190702	3	4	348	331	319	302	281	260	208	135														1159	1" ¼	11,4		
S4 3/6	60190703	0,37	0,5	33				32	31	30	26	23	13												378	1" ¼	3,2		
S4 3/9	60190704	0,55	0,75	50				47	45	44	40	34	20												461	1" ¼	3,7		
S4 3/13	60190705	0,75	1	72				68	66	64	57	50	29												572	1" ¼	4,2		
S4 3/19	60190706	1,1	1,5	105				100	98	93	86	72	42												739	1" ¼	5,5		
S4 3/25	60190707	1,5	2	138				130	127	122	110	95	55												784	1" ¼	6,2		
S4 3/32	60192288	2,2	3	176				168	162	157	141	120	70												987	1" ¼	7,8		
S4 3/39	60190708	2,2	3	215				204	198	191	172	147	86												1157	1" ¼	9,8		
S4 3/45	60192289	3	4	247				233	228	220	198	170	99												1301	1" ¼	11,1		
S4 3/51	60190709	3	4	280				267	260	250	224	193	112												1446	1" ¼	12,4		
S4 3/67	60190710	4	5,5	368				350	340	328	294	254	147												1827	1" ¼	16,2		
S4 4/4	60190711	0,37	0,5	28						25	24	22	17	11											313	1" ¼	2,7		
S4 4/7	60190712	0,55	0,75	48						44	41	38	30	19											388	1" ¼	3,2		
S4 4/9	60190713	0,75	1	62						56	53	49	39	25											440	1" ¼	3,6		
S4 4/14	60190714	1,1	1,5	96						87	82	76	61	39											567	1" ¼	4,5		
S4 4/19	60190715	1,5	2	131						118	112	103	82	53											694	1" ¼	5,8		
S4 4/27	60190716	2,2	3	186						168	159	147	117	75											807	1" ¼	7,6		
S4 4/35	60190717	3	4	241						218	206	191	152	97											981	1" ¼	9,2		
S4 4/48	60190718	4	5,5	331						299	283	261	208	133											1263	1" ¼	11,8		
S4 4/62	60190719	5,5	7,5	427						386	365	338	269	172											1567	1" ¼	14,4		
S4 6/5	60190720	0,55	0,75	30						28	26	24	21	19	15	10									374	1" ¼	3,2		
S4 6/7	60190721	0,75	1	42						38	37	33	29	27	21	14									440	1" ¼	3,6		
S4 6/10	60190722	1,1	1,5	60						55	52	47	42	38	30	20									539	1" ¼	4,3		
S4 6/14	60190723	1,5	2	84						78	75	66	59	53	42	28									672	1" ¼	5,1		
S4 6/21	60190724	2,2	3	126						116	110	99	88	80	63	42									872	1" ¼	7,8		
S4 6/29	60190725	3	4	174						160	152	137	122	110	87	58									1120	1" ¼	9,9		
S4 6/38	60190726	4	5,5	228						209	200	179	160	144	114	76									1399	1" ¼	12,3		
S4 6/52	60190727	5,5	7,5	312						285	274	244	218	198	156	104									1870	1" ¼	16,5		
S4 6/61	60192290	7,5	10	366						334	322	287	256	232	183	122									2148	1" ¼	19,2		
S4 8/5	60190728	0,75	1	30								30	28	27	26	24	21	16	11						450	2"	3,8		
S4 8/7	60190729	1,1	1,5	42								41	39	38	37	34	29	23	16						541	2"	4,5		
S4 8/9	60190730	1,5	2	54								52	50	49	48	44	37	29	20						631	2"	5,1		
S4 8/15	60190731	2,2	3	90								86	83	81	79	73	62	48	33						940	2"	7,2		
S4 8/21	60190732	3	4	130								125	120	117	112	103	86	68	47						1214	2"	9,0		
S4 8/27	60190733	4	5,5	162								155	151	146	144	132	111	87	60						1257	2"	12,4		
S4 8/35	60192313	5,5	7,5	210								202	195	192	187	171	144	113	78						1635	2"	14,7		
S4 8/38	60190734	5,5	7,5	228								219	211	207	203	186	156	122	84						1762	2"	16,5		
S4 8/47	60192314	7,5	10	280								270	261	255	251	230	193	151	104						2145	2"	19,0		
S4 8/50	60190735	7,5	10	298								288	278	273	267	244	206	161	111						2273	2"	21,4		
S4 12/6	60190736	1,1	1,5	30								29	28	25	24	23	21	18	11						536	2"	4,5		
S4 12/9	60190737	1,5	2	46								42	40	38	36	34	31	28	17						693	2"	5,8		
S4 12/13	60190738	2,2	3	66								61	59	55	52	49	44	38	23						900	2"	7,0		
S4 12/18	60190739	3	4	91								84	82	76	72	68	60	52	31						1167	2"	10,5		
S4 12/24	60190740	4	5,5	122								112	110	101	96	91	81	70	46						1479	2"	12,1		
S4 12/34	60190741	5,5	7,5	172								158	156	144	136	129	115	101	65						2035	2"	17,8		
S4 12/44	60190742	7,5	10	215								192	188	175	165	156	140	124	81						2552	2"	48,0		
S4 16/8	60190743	1,5	2	37													31	29	26	22	18	13	7		536	2"	6,0		
S4 16/12	60190744	2,2	3	55													46	43	39	33	27	19	10		1038	2"	8,8		
S4 16/16	60190745	3	4	73													61	57	52	44	36	25	13		1321	2"	11,5		
S4 16/21	60190746	4	5,5	96													81	75	68	58	47	33	18		1660	2"	14,7		
S4 16/29	60190747	5,5	7,5	133													111	104	94	80	65	46	24		2245	2"	20,0		
S4 16/38	60190748	7,5	10	174													146	136	124	105	86	60	32		2816	2"	52,0		



D+CONNECT  
 COMMAND AND CONTROL SYSTEMS  
 CIRCULATORS AND IN-LINE PUMPS  
 MULTISTAGE CENTRIFUGAL AND SELF-PRIMING PUMPS  
 SWIMMING POOL, POND AND SALT WATER PUMPS  
 CENTRIFUGAL PUMPS  
 SUBMERSIBLE PUMPS  
 SUBMERSIBLE PUMPS AND SUBMERSIBLE MOTORS  
 PRESSURE UNITS



# S4 - OIL FILLED MOTOR

4" SUBMERSIBLE PUMPS



4" multi-impeller borehole pumps for clean water, designed for water boosting, gardening and irrigation, lifting water from boreholes in residential building service, commercial building service and irrigation systems also for agriculture. **Only for extra EU markets.**

Hydraulic part built in stainless steel AISI 304, technopolymer is used for the parts in contact with water. Impellers and diffusers in technopolymer. Built-in check valve and suction filter. Single-phase version with manual resetting thermo-amperometric protection and condenser in the electrical control panel to be ordered separately (except for the kit version). The three-phase version must be protected by the user.

**Oil filled motor**

40L is a two-pole asynchronous motor in AISI 304L stainless steel for parts in contact with water. The cooling and lubrication of the ball bearings is guaranteed by a special liquid approved for food use. The rewindable stator is inserted in an AISI 304L stainless steel jacket secured by steel pins to the upper motor support. Equipped with a carbon-ceramic mechanical seal.

Motor suitable for use with inverters (30 Hz - 50 Hz). Electrical panel supplied or to be ordered separately depending on the configuration chosen. In the three-phase version the protection is the responsibility of the user.

**Flow rate maximum** up to 21,6 m<sup>3</sup>/h

**Head up to** 368 m

**Type of pumped liquid** Clean, free of solids and abrasive substances, non-viscous, non-aggressive, non-crystallized and chemically neutral.

**Pump maximum diameter** 99 mm

**Maximum amount of sand** 150 g/m<sup>3</sup>

**Impellers material**  
Technopolymer

**Liquid temperature range**  
From 0°C to + 40°C

**Max immersion depth**  
40L: 250 m

**Motor protection class** IP 68

**Motor insulation class** F

ONLY FOR  
**EXTRA EU**  
MARKETS

**SAND RESISTANT**

MODEL	P2 NOMINAL		DNM	VOLTAGE 1x230 ~ V					VOLTAGE 3x400 ~ V			VOLTAGE 3x230 ~ V				
	kW	HP		CODE	In A	WEIG. (Kg)	CONTROL BOX CODE	KIT WITH: pump, 40L motor, power supply cable, control box and cord			CODE	In A	WEIG. (Kg)	CODE	In A	WEIG. (Kg)
								KIT CODE	CABLE LENGTH	WEIG. (Kg)						
S4 1/10	0,37	0,5	1 1/4"	60197348	3,5	9,6	108003210	60197277	15	14,3	60197350	1,2	9,6	60197349	2,1	9,6
S4 1/13	0,37	0,5	1 1/4"	60197351	3,5	10	108003210	60197278	15	18,6	60197353	1,2	10	60197352	2,1	10
S4 1/19	0,55	0,75	1 1/4"	60197354	4,5	11,9	108003220	60197279	30	20,8	60197356	2,2	11	60197355	3,8	11
S4 1/26	0,75	1	1 1/4"	60197357	6,3	14,1	108003270	60197280	30	25,7	60197359	2,6	12,8	60197358	4,5	12,8
S4 1/37	1,1	1,5	1 1/4"	60197364	8,5	16,8	108003280	60197281	40	29,1	60197366	3,6	15,8	60197365	6,2	15,8
S4 2/7	0,37	0,5	1 1/4"	60197367	3,5	9,3	108003210	60197282	15	13,6	60197369	1,2	9,3	60197368	2,1	9,3
S4 2/10	0,55	0,75	1 1/4"	60197370	4,5	10,7	108003220	60197283	15	15	60197372	2,2	9,8	60197371	3,8	9,8
S4 2/14	0,75	1	1 1/4"	60197373	6,3	12,5	108003270	60197284	30	19,2	60197375	2,6	11,2	60197374	4,5	11,2
S4 2/20	1,1	1,5	1 1/4"	60197376	8,5	14,4	108003280	60197285	40	23,3	60197378	3,6	13,4	60197377	6,2	13,4
S4 2/28	1,5	2	1 1/4"	60197379	10,8	18,1	108003290	60197286	40	27	60197383	4,6	16,1	60197380	7,9	16,1
S4 2/40	2,2	3	1 1/4"	60197384	15	23,6	108003300	60197287	40	32,5	60197386	6	22,5	60197385	10,4	22,5
S4 2/52	3	4	1 1/4"								60197388	7,5	27,1	60197387	13	27,1
S4 3/6	0,37	0,5	1 1/4"	60197389	3,5	9,5	108003210	60197288	15	13,8	60197392	1,2	9,5	60197390	2,1	9,5
S4 3/9	0,55	0,75	1 1/4"	60197393	4,5	10,9	108003220	60197289	15	15,2	60197396	2,2	10	60197394	3,8	10
S4 3/13	0,75	1	1 1/4"	60197397	6,3	12,7	108003270	60197290	30	19,4	60197399	2,6	11,4	60197398	4,5	11,4
S4 3/19	1,1	1,5	1 1/4"	60197400	8,5	15	108003280	60197291	40	23,9	60197403	3,6	14	60197401	6,2	14
S4 3/25	1,5	2	1 1/4"	60197405	10,8	17,7	108003290	60197292	40	26,6	60197407	4,6	15,7	60197406	7,9	15,7
S4 3/32	2,2	3	1 1/4"	60197408	15	22,1	108003300	60197293	40	30,9	60197411	6	21	60197409	10,4	21
S4 3/39	2,2	3	1 1/4"	60197412	15	24,1	108003300	60197294	40	33	60197414	6	23	60197413	10,4	23
S4 3/45	3	4	1 1/4"								60197417	7,5	26,8	60197416	13	26,8
S4 3/51	3	4	1 1/4"								60197419	7,5	28,1	60197418	13	28,1
S4 3/67	4	5,5	1 1/4"								60197421	9,6	33,1	60197420	16,6	33,1

\* Control box not included





# S4 - OIL FILLED MOTOR



4" SUBMERSIBLE PUMPS



MODEL	P2 NOMINAL		DNM	VOLTAGE 1x230 ~ V						VOLTAGE 3x400 ~ V			VOLTAGE 3x230 ~ V			
	kW	HP		CODE	In A	WEIG. (Kg)	CONTROL BOX CODE	KIT WITH: pump, 40L motor, power supply cable, control box and cord			CODE	In A	WEIG. (Kg)	CODE	In A	WEIG. (Kg)
								KIT CODE	CABLE LENGTH	WEIG. (Kg)						
S4 4/4	0,37	0,5	1 1/4"	60197422	3,5	9	108003210	60197295	15	13,3	60197424	1,2	9	60197423	2,1	9
S4 4/7	0,55	0,75	1 1/4"	60197425	4,5	10,4	108003220	60197296	15	14,7	60197427	2,2	9,5	60197426	3,8	9,5
S4 4/9	0,75	1	1 1/4"	60197428	6,3	12,1	108003270	60197297	15	16,4	60197430	2,6	10,8	60197429	4,5	10,8
S4 4/14	1,1	1,5	1 1/4"	60197431	8,5	14	108003280	60197298	30	20,7	60197433	3,6	13	60197432	6,2	13
S4 4/19	1,5	2	1 1/4"	60197434	10,8	17,3	108003290	60197299	40	26,2	60197436	4,6	15,3	60197435	7,9	15,3
S4 4/27	2,2	3	1 1/4"	60197437	15	21,9	108003300	60197300	40	30,8	60197439	6	20,8	60197438	10,4	20,8
S4 4/35	3	4	1 1/4"								60197441	7,5	24,9	60197440	13	24,9
S4 4/48	4	5,5	1 1/4"								60197443	9,6	28,7	60197442	16,6	28,7
S4 6/5	0,55	0,75	1 1/4"	60197444	4,5	10,4	108003220	60197301	15	14,7	60197446	2,2	9,5	60197445	3,8	9,5
S4 6/7	0,75	1	1 1/4"	60197447	6,3	12,1	108003270	60197302	15	16,4	60197449	2,6	10,8	60197448	4,5	10,8
S4 6/10	1,1	1,5	1 1/4"	60197451	8,5	13,8	108003280	60197303	15	18,1	60197453	3,6	12,8	60197452	6,2	12,8
S4 6/14	1,5	2	1 1/4"	60197454	10,8	16,6	108003290	60197304	30	23,3	60197456	4,6	14,6	60197455	7,9	14,6
S4 6/21	2,2	3	1 1/4"	60197457	15	22,1	108003300	60197305	30	28,8	60197459	6	21	60197458	10,4	21
S4 6/29	3	4	1 1/4"								60197463	7,5	25,6	60197460	13	25,6
S4 6/38	4	5,5	1 1/4"								60197465	9,6	29,2	60197464	16,6	29,2
S4 6/52	5,5	7,5	1 1/4"								60197467	13,1	40,2	60197466	22,6	40,2
S4 8/4	0,75	1	2"	60197468	6,3	11,4	108003270	60197306	15	16,6	60197470	2,6	10,1	60197469	4,5	10,1
S4 8/6	1,1	1,5	2"	60197471	8,5	12,9	108003280	60197307	15	18,3	60197473	3,6	11,9	60197472	6,2	11,9
S4 8/8	1,5	2	2"	60197474	10,8	15,3	108003290	60197308	15	20,9	60197476	4,6	13,3	60197475	7,9	13,3
S4 8/13	2,2	3	2"	60197477	15	19,2	108003300	60197309	30	28,2	60197479	6	18,1	60197478	10,4	18,1
S4 8/17	3	4	2"								60197481	7,5	21,5	60197480	13	21,5
S4 8/23	4	5,5	2"								60197483	9,6	25,5	60197482	16,6	25,5
S4 8/32	5,5	7,5	2"								60197485	13,1	34,9	60197484	22,6	34,9
S4 8/43	5,5	7,5	2"								60197487	13,1	38,4	60197486	22,6	38,4
S4 12/5	1,1	1,5	2"	60197488	8,5	13,6	108003280	60197310	15	18,3	60197490	3,6	12,6	60197489	6,2	12,6
S4 12/8	1,5	2	2"	60197491	10,8	16,9	108003290	60197311	15	21,6	60197494	4,6	14,9	60197493	7,9	14,9
S4 12/11	2,2	3	2"	60197495	15	20,9	108003300	60197312	15	25,6	60197497	6	19,8	60197496	10,4	19,8
S4 12/15	3	4	2"								60197499	7,5	24,4	60197498	13	24,4
S4 12/20	4	5,5	2"								60197501	9,6	27,9	60197500	16,6	27,9
S4 12/27	5,5	7,5	2"								60197503	13,1	38,6	60197502	22,6	38,6
S4 12/36	7,5	10	2"								60197505	16,9	46,9	60197504	29,2	46,9
S4 16/5	1,5	2	2"	60197506	10,8	16,1	108003290	60197314	15	21,8	60197508	4,6	14,1	60197507	7,9	14,1
S4 16/8	2,2	3	2"	60197509	15	20,5	108003300	60197315	15	27,1	60197511	6	19,4	60197510	10,4	19,4
S4 16/11	3	4	2"								60197513	7,5	24,3	60197512	13	24,3
S4 16/15	4	5,5	2"								60197515	9,6	28	60197514	16,6	28
S4 16/20	5,5	7,5	2"								60197517	13,1	37,6	60197516	22,6	37,6
S4 16/28	7,5	10	2"								60197519	16,9	46,7	60197518	29,2	46,7

\* Control box not included

# S4

4" SUBMERSIBLE PUMPS



## ONLY PUMP END ONLY FOR EXTRA MARKETS EU

MODEL	CODICE	ELECTRIC DATA		HYDRAULIC DATA																								H mm	DNM	WEIGHT KG
		P2 NOMINAL	Q=m³h	0	0,3	0,6	0,9	1,2	1,5	1,8	2,4	3,0	4,2	5,4	6,0	7,2	8,4	9,6	10,8	12,0	15,0	18,0	22,0							
		KW	HP	Q=l/min	0	5	10	15	20	25	30	40	50	70	90	100	120	140	160	180	200	250	300	367						
S4 1/10	60197116	0,37	0,5		64	62	58	51	41	28														369	1 1/4"	3,1				
S4-1/13	60179752	0,37	0,5		82	80	75	66	53	36														423	1 1/4"	3,5				
S4-1/19	60179753	0,55	0,75		124	121	112	98	78	54														528	1 1/4"	4,5				
S4-1/26	60179754	0,75	1		169	163	149	129	102	69														652	1 1/4"	5,4				
S4-1/37	60191549	1,1	1,5		225	218	200	172	134	85														882	1 1/4"	7,1				
S4-2/7	60173437	0,37	0,5		47				42	40	37	29	19											337	1 1/4"	2,8				
S4-2/10	60173438	0,55	0,75		67				60	56	52	41	27											398	1 1/4"	3,3				
S4-2/10	60173439	0,75	1		93				84	79	73	57	37											481	1 1/4"	3,8				
S4-2/20	60173440	1,1	1,5		130				119	113	104	82	53											604	1 1/4"	4,7				
S4-2/28	60173445	1,5	2		187				168	158	146	114	74											677	1 1/4"	6,4				
S4-2/40	60173442	2,2	3		267				240	225	208	163	107											923	1 1/4"	9,1				
S4-2/52	60173444	3	4		347				312	293	270	212	139											1134	1 1/4"	11,2				
S4 3/6	60196432	0,37	0,5		33				32	31	30	27	23	13										363	1 1/4"	3				
S4 3/9	60196433	0,55	0,75		50				47	46	44	40	34	20										446	1 1/4"	3,5				
S4 3/13	60196434	0,75	1		72				68	66	64	57	50	29										557	1 1/4"	4				
S4 3/19	60196435	1,1	1,5		105				100	97	94	85	73	42										724	1 1/4"	5,3				
S4 3/25	60196436	1,5	2		138				131	127	122	110	95	55										769	1 1/4"	6				
S4 3/32	60196437	2,2	3		176				167	162	156	141	121	69										972	1 1/4"	7,6				
S4 3/39	60196438	2,2	3		215				204	198	191	172	148	86										1142	1 1/4"	9,6				
S4 3/45	60196439	3	4		247				234	227	219	198	171	99										1286	1 1/4"	10,9				
S4 3/51	60196440	3	4		281				267	259	249	225	194	111										1431	1 1/4"	12,2				
S4 3/67	60196441	4	5,5		368				350	339	327	295	255	147										1812	1 1/4"	16				
S4-4/4	60173441	0,37	0,5		27						25	23	21	16	9									295	1 1/4"	2,5				
S4-4/7	60173443	0,55	0,75		46						43	40	37	28	16									372	1 1/4"	3				
S4-4/9	60173450	0,75	1		59						55	52	47	36	20									423	1 1/4"	3,4				
S4-4/14	60173449	1,1	1,5		93						86	80	74	55	31									550	1 1/4"	4,3				
S4-4/19	60173446	1,5	2		126						116	109	100	75	42									678	1 1/4"	5,6				
S4-4/27	60173447	2,2	3		179						165	155	142	107	60									807	1 1/4"	7,4				
S4-4/35	60173448	3	4		226						209	195	179	135	76									981	1 1/4"	9				
S4-4/48	60173451	4	5,5		320						294	275	252	189	107									1263	1 1/4"	11,6				
S4-6/5	60173453	0,55	0,75		30							27	26	23	20	18	15	10						358	1 1/4"	3				
S4-6/7	60173455	0,75	1		43							38	36	33	28	26	20	14						424	1 1/4"	3,4				
S4-6/10	60173452	1,1	1,5		61							54	52	47	40	37	30	22						523	1 1/4"	4,1				
S4-6/14	60173454	1,5	2		85							76	73	66	57	52	42	30						655	1 1/4"	4,9				
S4-6/21	60173460	2,2	3		125							113	109	98	85	78	62	43						873	1 1/4"	7,6				
S4-6/29	60173457	3	4		173							157	151	136	118	108	85	59						1121	1 1/4"	9,7				
S4-6/38	60173459	4	5,5		227							205	197	178	154	141	111	77						1400	1 1/4"	12,1				
S4-6/52	60173458	5,5	7,5		311							280	269	243	211	192	152	105						1871	1 1/4"	16,3				
S4-8/4	60173456	0,75	1		25							25	25	24	22	22	20	17	15	12				335	2"	2,7				
S4-8/6	60173462	1,1	1,5		38							37	37	35	33	32	29	26	22	17				401	2"	3,2				
S4-8/8	60173464	1,5	2		51							50	49	48	45	43	39	34	28	22				467	2"	3,6				
S4-8/13	60173463	2,2	3		83							80	79	76	71	69	63	56	47	38				632	2"	4,7				
S4-8/17	60173461	3	4		109							105	104	99	93	90	82	73	63	52				764	2"	5,6				
S4-8/23	60173465	4	5,5		148							142	140	134	126	121	110	98	84	68				945	2"	8,4				
S4-8/32	60173467	5,5	7,5		205							196	193	184	173	167	153	136	118	97				1224	2"	11				
S4-8/43	60173468	5,5	7,5		275							264	259	248	234	225	206	184	159	131				1602	2"	14,5				
S4-12/5	60173466	1,1	1,5		31											26	25	24	22	20	18	12		463	2"	3,9				
S4-12/8	60173469	1,5	2		49											42	40	38	35	32	29	19		619	2"	5,2				
S4-12/11	60173470	2,2	3		67											58	56	52	48	44	40	26		776	2"	6,4				
S4-12/15	60173471	3	4		92											79	75	71	65	60	54	36		1011	2"	8,5				
S4-12/20	60173473	4	5,5		122											105	100	94	87	80	72	48		1271	2"	10,8				
S4-12/27	60173475	5,5	7,5		165											143	135	127	118	108	97	66		1672	2"	14,7				
S4-12/36	60173474	7,5	10		221											189	180	169	156	143	129	87		2140	2"	19				
S4-16/5	60173472	1,5	2		29													23	22	21	20	17	14	10	543	2"	4,4			
S4-16/8	60173477	2,2	3		47													38	36	34	32	28	23	16	747	2"	6			
S4-16/11	60173479	3	4		65													51	49	47	44	38	31	22	979	2"	8,4			
S4-16/15	60173480	4	5,5		89													70	67	64	60	52	43	30	1251	2"	10,9			
S4-16/20	60173476	5,5	7,5		119													94	90	85	81	70	58	40	1628	2"	13,7			
S4-16/28	60173478	7,5	10		165													130	125	119	113	97	80	56	2172	2"	18,8			



D+CONNECT  
 COMMAND AND CONTROL SYSTEMS  
 CIRCULATORS AND IN-LINE PUMPS  
 MULTISTAGE CENTRIFUGAL AND SELF-PRIMING PUMPS  
 SWIMMING POOL, POND AND SALT WATER PUMPS  
 CENTRIFUGAL PUMPS  
 SUBMERSIBLE PUMPS  
 SUBMERSIBLE PUMPS AND SUBMERSIBLE MOTORS  
 PRESSURE UNITS

# 4GG

## 4" SUBMERSIBLE MOTORS



4" Asynchronous two-poles submersible motor, **made in AISI 304 stainless steel** for parts in contact with water. Cooling and lubrication of the thrust bearing assembly and carbon bushes is provided by a **mixture of water and glycol**. Squirrel-cage rotor mounted on Kingsbury self-centring thrust bearing.

**Stainless steel canned stator, filled with thermosetting resin with high insulation property and better thermal dissipation capability.**

Removable cable connector to allow fast and easy maintenance. The cable is certified ACS, WRAS and KTW. Motor suitable for use with variable frequency drive (30 Hz – 50 Hz). Capacitor and manually resettable overload protection located in the electric panel that can be supplied separately for the single-phase 50 Hz version. Overload protection must be provided by user for the three-phase version.

**Flanging** NEMA - 4"

**Protection level** IP 68

**Insulation class** F

**Voltage**

single-phase 220-230 V / 50 Hz

Three-phase 400 V / 50 Hz - 230 V / 50 Hz

**Equipped with cable**

1,7 m for motor power up to 2,2 kW

2,7 m for motor power up to 3 kW

3,5 m for motor power of 7,5 kW

**Available on request** cables of different lengths, different supply voltage, thermal surge protector

**tesla**



**ACCESSORIES**  
PAG. 319

MODEL	CODE	P2 (HP)	P2 kW	VOLTAGE 50 Hz	IN (A)	Is/In	Cs/Cn	P1 (W)	N (min <sup>-1</sup> )	Cos φ	η %	C (μF)	CABLE	
													Ø mm <sup>2</sup>	LC (m)
4GG - 0,37 KW - 230 V - M	60122739	0,5	0,37	1x230 V ~	3,3	2,7	0,69	740	2820	0,97	50	16	4x1,5	1,7
4GG - 0,55 KW - 230 V - M	60122740	0,75	0,55	1x230 V ~	4,6	3,3	0,68	1000	2820	0,94	56	20	4x1,5	1,7
4GG - 0,75 KW - 230 V - M	60122741	1	0,75	1x230 V ~	6,2	3,2	0,66	1300	2820	0,92	58	25	4x1,5	1,7
4GG - 1,1 KW - 230 V - M	60122742	1,5	1,1	1x230 V ~	8,6	3,6	0,68	1820	2830	0,90	62	35	4x1,5	1,7
4GG - 1,5 KW - 230 V - M	60122743	2	1,5	1x230 V ~	11	3,7	0,62	2320	2830	0,91	65	40	4x1,5	1,7
4GG - 2,2 KW - 230 V - M	60122744	3	2,2	1x230 V ~	16	3,1	0,6	3460	2810	0,89	65	60	4x1,5	1,7
4GG - 3 KW - 230 V - M	60185921	4	3	1x230 V ~	23,5	3,6	0,51	4900	2830	0,9	62	90	4x2	2,7
4GG - 3,7 KW - 230 V - M	60122779	5	3,7	1x230 V ~	25	3,6	0,51	5500	2850	0,95	65	90	4x2	2,7
4GG - 4 KW - 230 V - M	60185385	5,5	4	1x230 V ~	27	3,6	0,51	6000	2840	0,96	67	90	4x2	2,7
4GG - 0,37 KW - 400 V - T	60122746	0,5	0,37	3x400 V ~	1,4	3,8	3	710	2820	0,66	53	-	4x1,5	1,7
4GG - 0,37 KW - 230 V - T	60122745	0,5	0,37	3x230 V ~	2,7	3,7	3	710	2820	0,66	53	-	4x1,5	1,7
4GG - 0,55 KW - 400 V - T	60122748	0,75	0,55	3x400 V ~	1,9	4,2	3,1	920	2830	0,72	60	-	4x1,5	1,7
4GG - 0,55 KW - 230 V - T	60122747	0,75	0,55	3x230 V ~	3,3	4,2	3,1	920	2830	0,72	60	-	4x1,5	1,7
4GG - 0,75 KW - 400 V - T	60122750	1	0,75	3x400 V ~	2,4	5,0	3,2	1190	2830	0,73	63	-	4x1,5	1,7
4GG - 0,75 KW - 230 V - T	60122749	1	0,75	3x230 V ~	4,1	5,1	3,2	1190	2830	0,72	63	-	4x1,5	1,7
4GG - 1,1 KW - 400 V - T	60122752	1,5	1,1	3x400 V ~	3,4	4,1	3,3	1720	2830	0,76	64	-	4x1,5	1,7
4GG - 1,1 KW - 230 V - T	60122751	1,5	1,1	3x230 V ~	5,7	4,2	3,3	1720	2830	0,72	64	-	4x1,5	1,7
4GG - 1,5 KW - 400 V - T	60122754	2	1,5	3x400 V ~	4,4	4,3	3,4	2200	2830	0,72	68	-	4x1,5	1,7
4GG - 1,5 KW - 230 V - T	60122753	2	1,5	3x230 V ~	7,6	4,3	3,4	2200	2830	0,72	68	-	4x1,5	1,7
4GG - 2,2 KW - 400 V - T	60122756	3	2,2	3x400 V ~	5,9	4,4	3,2	3170	2820	0,78	71	-	4x1,5	1,7
4GG - 2,2 KW - 230 V - T	60122755	3	2,2	3x230 V ~	10,2	4,4	3,2	3170	2820	0,78	71	-	4x1,5	1,7
4GG - 3,0 KW - 400 V - T	60122758	4	3	3x400 V ~	8,3	4,6	3,3	4050	2840	0,71	74	-	4x1,5	2,7
4GG - 3,0 KW - 230 V - T	60122757	4	3	3x230 V ~	14,3	4,6	3,3	4050	2840	0,71	74	-	4x1,5	2,7
4GG - 4,0 KW - 400 V - T	60122760	5,5	4	3x400 V ~	10	5,6	3,4	5340	2850	0,79	75	-	4x1,5	2,7
4GG - 4,0 KW - 230 V - T	60122759	5,5	4	3x230 V ~	17,3	5,6	3,4	5340	2850	0,79	75	-	4x2	2,7
4GG - 5,5 KW - 400 V - T	60122762	7,5	5,5	3x400 V ~	14	5,5	3,4	7110	2850	0,74	77	-	4x1,5	2,7
4GG - 5,5 KW - 230 V - T	60122761	7,5	5,5	3x230 V ~	24,2	5,5	3,4	7110	2850	0,74	77	-	4x2	2,7
4GG - 7,5 KW - 400 V - T	60122763	10	7,5	3x400 V ~	17,4	4,8	2,9	9520	2850	0,080	79	-	4x2	3,5

# 4GX

## 4" SUBMERSIBLE MOTORS



4" Asynchronous two-poles submersible motor, **made in full AISI 316 stainless steel**. Cooling and lubrication of the thrust bearing assembly and carbon brushes is provided by a **mixture of water and glycol**. Squirrel-cage rotor mounted on Kingsbury self-centring thrust bearing.

**Stainless steel canned stator, filled with thermosetting resin with high insulation property and better thermal dissipation capability.**

Removable cable connector to allow fast and easy maintenance. The cable is certified ACS, WRAS and KTW. Motor suitable for use with variable frequency drive (30 Hz – 50 Hz). Mechanical seal in silicon/carbide. Capacitor and manually resettable overload protection located in the electric panel that can be supplied separately for the single-phase 50 Hz version. Overload protection must be provided by user for the three-phase version.

**Flanging** NEMA - 4"

**Protection level** IP 68

**Insulation class** F

**Voltage**

single-phase 220-230 V / 50 Hz

Three-phase 400 V / 50 Hz - 230 V / 50 Hz

**Equipped with cable**

1,7 m for motor power up to 2,2 kW

2,7 m for motor power up to 3 kW

3,5 m for motor power of 7,5 kW

**Available on request** cables of different lengths, different supply voltage, thermal surge protector



**AISI 316**

MODEL	CODE	P2 (HP)	P2 kW	VOLTAGE 50 Hz	IN (A)	Is/In	Cs/Cn	P1 (W)	N (min <sup>-1</sup> )	Cos φ	η %	C (μF)	CABLE	
													Ø mm <sup>2</sup>	LC (m)
4GX - 0,37 KW - 230 V - M	60141577	0,5	0,37	1x230 V ~	3,3	2,7	0,69	740	2820	0,97	50	16	4x1,5	1,7
4GX - 0,55 KW - 230 V - M	60141580	0,75	0,55	1x230 V ~	4,6	3,3	0,68	1000	2820	0,94	56	20	4x1,5	1,7
4GX - 0,75 KW - 230 V - M	60141584	1	0,75	1x230 V ~	6,2	3,2	0,66	1300	2820	0,92	58	25	4x1,5	1,7
4GX - 1,1 KW - 230 V - M	60141590	1,5	1,1	1x230 V ~	8,6	3,6	0,68	1820	2830	0,90	62	35	4x1,5	1,7
4GX - 1,5 KW - 230 V - M	60141593	2	1,5	1x230 V ~	11	3,7	0,62	2320	2830	0,91	65	40	4x1,5	1,7
4GX - 2,2 KW - 230 V - M	60141596	3	2,2	1x230 V ~	16	3,1	0,6	3460	2810	0,89	65	60	4x1,5	1,7
4GX - 0,37 KW - 400 V - T	60141578	0,5	0,37	3x400 V ~	1,4	3,8	3	710	2820	0,66	53	-	4x1,5	1,7
4GX - 0,37 KW - 230 V - T	60141579	0,5	0,37	3x230 V ~	2,7	3,7	3	710	2820	0,66	53	-	4x1,5	1,7
4GX - 0,55 KW - 400 V - T	60141581	0,75	0,55	3x400 V ~	1,9	4,2	3,1	920	2830	0,72	60	-	4x1,5	1,7
4GX - 0,55 KW - 230 V - T	60141582	0,75	0,55	3x230 V ~	3,3	4,2	3,1	920	2830	0,72	60	-	4x1,5	1,7
4GX - 0,75 KW - 400 V - T	60141586	1	0,75	3x400 V ~	2,4	5,0	3,2	1190	2830	0,73	63	-	4x1,5	1,7
4GX - 0,75 KW - 230 V - T	60141589	1	0,75	3x230 V ~	4,1	5,1	3,2	1190	2830	0,72	63	-	4x1,5	1,7
4GX - 1,1 KW - 400 V - T	60141591	1,5	1,1	3x400 V ~	3,4	4,1	3,3	1720	2830	0,76	64	-	4x1,5	1,7
4GX - 1,1 KW - 230 V - T	60141592	1,5	1,1	3x230 V ~	5,7	4,2	3,3	1720	2830	0,72	64	-	4x1,5	1,7
4GX - 1,5 KW - 400 V - T	60141594	2	1,5	3x400 V ~	4,4	4,3	3,4	2200	2830	0,72	68	-	4x1,5	1,7
4GX - 1,5 KW - 230 V - T	60141595	2	1,5	3x230 V ~	7,6	4,3	3,4	2200	2830	0,72	68	-	4x1,5	1,7
4GX - 2,2 KW - 400 V - T	60141597	3	2,2	3x400 V ~	5,9	4,4	3,2	3170	2820	0,78	71	-	4x1,5	1,7
4GX - 2,2 KW - 230 V - T	60141598	3	2,2	3x230 V ~	10,2	4,4	3,2	3170	2820	0,78	71	-	4x1,5	1,7
4GX - 3,0 KW - 400 V - T	60141607	4	3	3x400 V ~	8,3	4,6	3,3	4050	2840	0,71	74	-	4x1,5	2,7
4GX - 3,0 KW - 230 V - T	60141608	4	3	3x230 V ~	14,3	4,6	3,3	4050	2840	0,71	74	-	4x1,5	2,7
4GX - 4,0 KW - 400 V - T	60141612	5,5	4	3x400 V ~	10	5,6	3,4	5340	2850	0,79	75	-	4x1,5	2,7
4GX - 4,0 KW - 230 V - T	60141613	5,5	4	3x230 V ~	17,3	5,6	3,4	5340	2850	0,79	75	-	4x2	2,7
4GX - 5,5 KW - 400 V - T	60141614	7,5	5,5	3x400 V ~	14	5,5	3,4	7110	2850	0,74	77	-	4x1,5	2,7
4GX - 5,5 KW - 230 V - T	60141615	7,5	5,5	3x230 V ~	24,2	5,5	3,4	7110	2850	0,74	77	-	4x2	2,7
4GX - 7,5 KW - 400 V - T	60141616	10	7,5	3x400 V ~	17,4	4,8	2,9	9520	2850	0,080	79	-	4x2	3,5

# 4TW

## 4" SUBMERSIBLE MOTORS



The 4TW is a 4-inch single-phase submersible motor, designed for pressure boosting, gardening and irrigation, drawing water from subsoil in civil and commercial applications and for using water in irrigation systems also in agriculture.

Motor with the parts in contact with water made of AISI 304 stainless steel. Encapsulated and resin-filled stator. Cooled and lubricated with a mixture of water and glycol. Combined with the pump body, it is able to increase the water pressure, draw water from wells, tanks or reservoirs and to allow it to be used also for irrigating medium and large-sized vegetable gardens. **It has an integrated capacitor which does away with the external control panel.**

**Flanging** NEMA 4"

**Insulation class** F

**Protection class** IP68

**Cooling flow speed** min. 0,3 m/s 35 °C

**Power supply tolerance** + 6 % / -10 %

**Max. starts** 20/h

**Max operating depth** 300 m

**Possible type of installation**

Vertical or horizontal

**Horizontal operation** 0,5 HP - 1,5 HP

**On request** cables of different lengths and different power input voltages



ACCESSORIES  
PAG. 319

MODEL	CODE	P2 (HP)	P2 kW	VOLTAGE 50 Hz	IN (A)	Is/In	Cs/Cn	P1 (W)	N (min <sup>-1</sup> )	Cos φ	η %	C (μF)	CABLE	
													∅ mm <sup>2</sup>	LC (m)
4TW - 0,37 KW - 230 V - M	60191544	0,5	0,37	1x230 V ~	3,3	2,7	0,69	740	2820	0,97	50	16	3x1,5	1,7
4TW - 0,55 KW - 230 V - M	60191545	0,75	0,55	1x230 V ~	4,6	3,3	0,68	1000	2820	0,94	56	20	3x1,5	1,7
4TW - 0,75 KW - 230 V - M	60191546	1	0,75	1x230 V ~	6,2	3,2	0,66	1300	2820	0,92	58	25	3x1,5	1,7
4TW - 1,1 KW - 230 V - M	60191547	1,5	1,1	1x230 V ~	8,6	3,6	0,68	1820	2830	0,92	62	35	3x1,5	1,7

## 40L

## 4" SUBMERSIBLE MOTORS



4" Asynchronous two-poles submersible motor, rewindable-type, made in AISI 304 stainless steel for parts in contact with water. Cooling and lubrication of the ball bearings is provided by a special FDA-approved liquid. Stator housed in an external shell in AISI 304L (rewindable-type) connected with stainless steel pins to the upper support of the motor. Removable cable connector to allow fast and easy maintenance. The cable is certified ACS, WRAS and KTW. Motor suitable for use with variable frequency drive (30 Hz – 50 Hz). Mechanical seal in ceramic-carbon. Capacitor and manually resettable overload protection located in the electric panel that can be supplied separately for the single-phase version. Overload protection must be provided by user for the three-phase version. The motor can be equipped with a PT100 temperature sensor.



**Flanging** NEMA 4".

**Insulation class** F.

**Protection class** IP68.

**Cooling flow speed** min. 0,3 m/s 35 °C.

**Power supply tolerance** + 6 % / - 10 %.

**Max. starts** 20/h.

**Max operating depth** 250 m.

**Horizontal operation** 0,5 HP - 10 HP.



ACCESSORIES  
PAG. 319

MODEL	CODE	P2 (HP)	P2 kW	VOLTAGE 50 Hz	IN (A)	Is/In	Cs/Cn	P1 (W)	N (min <sup>-1</sup> )	Cos φ	η %	C (μF)	CABLE	
													Ø mm <sup>2</sup>	LC (m)
40L - 0,37 KW - 230 V - M	60168915	0,5	0,37	1x230 V ~	3,5	2,6	0,64	725	2800	0,9	51	16	4x1,5	1,7
40L - 0,55 KW - 230 V - M	60168916	0,75	0,55	1x230 V ~	4,5	2,7	0,60	950	2800	0,92	58	20	4x1,5	1,7
40L - 0,75 KW - 230 V - M	60168917	1	0,75	1x230 V ~	6,3	3,2	0,64	1275	2820	0,88	59	25	4x1,5	1,7
40L - 1,1 KW - 230 V - M	60168918	1,5	1,1	1x230 V ~	8,5	2,9	0,54	1780	2800	0,91	62	35	4x1,5	1,7
40L - 1,5 KW - 230 V - M	60168919	2	1,5	1x230 V ~	10,8	3,2	0,43	2160	2800	0,87	69	40	4x1,5	1,7
40L - 2,2 KW - 230 V - M	60169099	3	2,2	1x230 V ~	14	3,2	0,57	3060	2800	0,87	78	60	4x1,5	1,7
40L - 3 KW - 230 V - M	60183432	4	3	1x230 V ~	23,5	3,6	0,51	4900	2830	0,9	62	90	4x2	2,7
40L - 3,7 KW - 230 V - M	60169100	5	3,7	1x230 V ~	25,4	3,6	0,51	5500	2850	0,95	66	90	4x2	2,7
40L - 4 KW - 230 V - M	60185382	5,5	4	1x230 V ~	27	3,6	0,51	6000	2840	0,96	67	90	4x2	2,7
40L - 0,37 KW - 400 V - T	60168928	0,5	0,37	3x400 V ~	1,6	3,3	3,5	700	2820	0,63	53	-	4x1,5	1,7
40L - 0,37 KW - 230 V - T	60168920	0,5	0,37	3x230 V ~	2,8	3,2	3,5	700	2820	0,63	53	-	4x1,5	1,7
40L - 0,55 KW - 400 V - T	60168929	0,75	0,55	3x400 V ~	2,2	3,4	3,9	980	2820	0,64	56	-	4x1,5	1,7
40L - 0,55 KW - 230 V - T	60168921	0,75	0,55	3x230 V ~	3,8	3,4	3,9	980	2820	0,64	56	-	4x1,5	1,7
40L - 0,75 KW - 400 V - T	60168930	1	0,75	3x400 V ~	2,6	3,8	3,7	1200	2820	0,68	62	-	4x1,5	1,7
40L - 0,75 KW - 230 V - T	60168922	1	0,75	3x230 V ~	4,5	3,8	3,7	1200	2820	0,68	62	-	4x1,5	1,7
40L - 1,1 KW - 400 V - T	60168931	1,5	1,1	3x400 V ~	3,6	4,4	4,3	1700	2830	0,68	65	-	4x1,5	1,7
40L - 1,1 KW - 230 V - T	60168923	1,5	1,1	3x230 V ~	6,2	4,5	4,3	1700	2830	0,68	65	-	4x1,5	1,7
40L - 1,5 KW - 400 V - T	60168932	2	1,5	3x400 V ~	4,6	4,3	4,4	2160	2810	0,68	69	-	4x1,5	1,7
40L - 1,5 KW - 230 V - T	60168924	2	1,5	3x230 V ~	7,9	4,4	4,4	2160	2810	0,68	69	-	4x1,5	1,7
40L - 2,2 KW - 400 V - T	60167638	3	2,2	3x400 V ~	6	5,2	3,3	3050	2810	0,7	72	-	4x1,5	1,7
40L - 2,2 KW - 230 V - T	60168925	3	2,2	3x230 V ~	10,4	5,2	3,3	3050	2810	0,7	72	-	4x1,5	1,7
40L - 3 KW - 400 V - T	60167644	4	3	3x400 V ~	7,9	5,7	3,3	4000	2840	0,73	75	-	4x1,5	2,7
40L - 3 KW - 230 V - T	60168926	4	3	3x230 V ~	13,6	5,7	3,3	4000	2840	0,73	75	-	4x1,5	2,7
40L - 4 KW - 400 V - T	60167647	5,5	4	3x400 V ~	10,2	5,4	3,4	5260	2850	0,74	76	-	4x1,5	2,7
40L - 4 KW - 230 V - T	60168927	5,5	4	3x230 V ~	17,6	5,4	3,4	5260	2850	0,74	76	-	4x2	2,7
40L - 5,5 KW - 400 V - T	60169101	7,5	5,5	3x400 V ~	13,1	5,3	3,4	6900	2850	0,76	80	-	4x1,5	2,7
40L - 5,5 KW - 230 V - T	60169103	7,5	5,5	3x230 V ~	22,6	5,4	3,4	6900	2850	0,76	80	-	4x2	2,7
40L - 7,5 KW - 400 V - T	60169102	10	7,5	3x400 V ~	16,9	5,0	3	9030	2840	0,77	81	-	4x2	3,5
40L - 7,5 KW - 230 V - T	60169104	10	7,5	3x230 V ~	29,2	5,0	3	9030	2840	0,77	81	-	4x2	3,5

## SS6

## 6" SUBMERSIBLE PUMPS



Multistage **semiaxial** submersible electric pumps for wells measuring 6" or above, able to generate a broad range of flow rates. These units are used extensively for lifting, distribution, and pressurisation in civil and industrial water systems, filling of booster pumps and tanks, fire-fighting systems and washing of irrigation systems. Application with clean, non-aggressive water free from solids or abrasive substances.

**Construction features of the pump**

Pump body and impellers in pressed AISI 304 stainless steel.  
Pump with check valve of low pressure loss.

**For operation with inverter see the specifications of the coupled motor.****On request**

- **Pump body:** in pressed AISI 316 stainless steel for use in aggressive water.
- **Impellers:** in pressed AISI 316 stainless steel for use in aggressive water.

**Performance range**

flow up to 75 m<sup>3</sup>/h and max head of 670 m

**Max. quantity of sand/silt** 50g/m<sup>3</sup>

**Max. ambient temperature**

30°C (50°C available on request)

**Outlet connection diameter (inside threaded)**

SS6 A / SS6 B : 2 1/2"

SS6 C : 3"

SS6 D – SS6 E : 4"

Coupling with motors of 4", 6" or 8" depending on the required hydraulic power, and available in standard or stainless steel version:

**4GG:** encapsulated 4" submersible motor.

**40L:** 4" submersible motor in oil bath.

**6GF:** encapsulated 6" submersible motor.

**TR6:** rewindable 6" submersible motor.

**TR8:** rewindable 8" submersible motor.



ACCESSORIES  
PAG. 319

## SS6A HYDRAULIC PART

MODEL	HYDRAULIC PART CODE	MOTOR COUPLING	ELECTRICAL DATA		HYDRAULIC DATA													DNM GAS	WEIGHT KG	H mm
			P2 NOMINAL REQUESTED		Q=m <sup>3</sup> /h	0,0	2,0	4,0	6,0	8,0	10,0	12,0	14,0	16,0	17,0					
			kW	HP	Q=l/sec	0,0	0,6	1,1	1,7	2,2	2,8	3,3	3,9	4,4	4,7					
SS6A 01	60170099	4"	0,55	0,75	H (mt)	9	9	9	9	9	8	7	6	5	4	2 1/2"	5	566		
SS6A 02	60170100	4"	1,1	1,5		19	19	19	18	17	16	15	13	10	9	2 1/2"	7	676		
SS6A 03	60170101	4"	1,5	2		28	28	28	27	26	24	22	19	15	13	2 1/2"	8	799		
SS6A 04	60170102	4"	2,2	3		37	37	37	36	35	32	29	25	20	18	2 1/2"	10	904		
SS6A 05	60170103	4"	2,2	3		47	47	46	45	43	41	37	32	26	22	2 1/2"	11	965		
SS6A 06	60170104	4"	2,2	3		56	56	56	54	52	49	44	38	31	27	2 1/2"	13	1025		
SS6A 07	60170105	4"	3	4		65	66	65	64	61	57	51	44	36	31	2 1/2"	14	1237		
SS6A 08	60170106	4"	4	5,5		75	75	74	73	70	65	59	51	41	36	2 1/2"	15	753		
SS6A 08	60167875	6"	4	5,5		75	75	74	73	70	65	59	51	41	36	2 1/2"	15	753		
SS6A 09	60170107	4"	4	5,5		84	84	84	82	78	73	66	57	46	40	2 1/2"	17	814		
SS6A 09	60167876	6"	4	5,5		84	84	84	82	78	73	66	57	46	40	2 1/2"	17	814		
SS6A 10	60170108	4"	4	5,5		93	94	93	91	87	81	73	63	51	44	2 1/2"	18	874		
SS6A 10	60167877	6"	4	5,5		93	94	93	91	87	81	73	63	51	44	2 1/2"	18	874		
SS6A 11	60170109	4"	4	5,5		103	103	102	100	96	89	81	70	56	49	2 1/2"	20	935		
SS6A 11	60167878	6"	4	5,5		103	103	102	100	96	89	81	70	56	49	2 1/2"	20	935		
SS6A 12	60170110	4"	5,5	7,5		112	112	112	109	104	97	88	76	61	53	2 1/2"	21	995		
SS6A 12	60167879	6"	5,5	7,5	112	112	112	109	104	97	88	76	61	53	2 1/2"	21	995			
SS6A 13	60170111	4"	5,5	7,5	121	122	121	118	113	105	95	82	67	58	2 1/2"	23	1056			
SS6A 13	60167880	6"	5,5	7,5	121	122	121	118	113	105	95	82	67	58	2 1/2"	23	1056			

# SS6

6" SUBMERSIBLE PUMPS



## SS6A HYDRAULIC PART

MODEL	HYDRAULIC PART CODE	MOTOR COUPLING	ELECTRICAL DATA		HYDRAULIC DATA													DNM GAS	WEIGHT KG	H mm
			P2 NOMINAL REQUESTED		Q=m³h	0,0	2,0	4,0	6,0	8,0	10,0	12,0	14,0	16,0	17,0					
			kW	HP	Q=l/sec	0,0	0,6	1,1	1,7	2,2	2,8	3,3	3,9	4,4	4,7					
SS6A 14	60170112	4"	5,5	7,5	H (m)	131	131	130	127	122	114	103	89	72	62	2 1/2"	24	1116		
SS6A 14	60167881	6"	5,5	7,5		131	131	130	127	122	114	103	89	72	62	2 1/2"	24	1116		
SS6A 15	60170113	4"	5,5	7,5		140	140	139	136	130	122	110	95	77	67	2 1/2"	26	1177		
SS6A 15	60167882	6"	5,5	7,5		140	140	139	136	130	122	110	95	77	67	2 1/2"	26	1177		
SS6A 16	60170116	4"	7,5	10		149	150	149	145	139	130	117	101	82	71	2 1/2"	27	1237		
SS6A 16	60167885	6"	7,5	10		149	150	149	145	139	130	117	101	82	71	2 1/2"	27	1237		
SS6A 17	60170118	4"	7,5	10		159	159	158	154	148	138	124	108	87	76	2 1/2"	28	1298		
SS6A 17	60167886	6"	7,5	10		159	159	158	154	148	138	124	108	87	76	2 1/2"	28	1298		
SS6A 18	60170120	4"	7,5	10		168	169	167	163	156	146	132	114	92	80	2 1/2"	30	1358		
SS6A 18	60167887	6"	7,5	10		168	169	167	163	156	146	132	114	92	80	2 1/2"	30	1358		
SS6A 19	60170122	4"	7,5	10		177	178	177	172	165	154	139	120	97	84	2 1/2"	31	1419		
SS6A 19	60167888	6"	7,5	10		177	178	177	172	165	154	139	120	97	84	2 1/2"	31	1419		
SS6A 20	60170124	4"	7,5	10		187	187	186	182	174	162	146	127	102	89	2 1/2"	33	1479		
SS6A 20	60167889	6"	7,5	10		187	187	186	182	174	162	146	127	102	89	2 1/2"	33	1479		
SS6A 21	60170125	4"	7,5	10		196	197	195	191	182	170	154	133	108	93	2 1/2"	34	1540		
SS6A 21	60167892	6"	7,5	10		196	197	195	191	182	170	154	133	108	93	2 1/2"	34	1540		
SS6A 22	60167893	6"	9,3	12,5		205	206	204	200	191	178	161	139	113	98	2 1/2"	36	1600		
SS6A 23	60167894	6"	9,3	12,5		215	215	214	209	200	186	168	146	118	102	2 1/2"	37	1661		
SS6A 24	60167895	6"	9,3	12,5		224	225	223	218	209	195	176	152	123	107	2 1/2"	39	1721		
SS6A 25	60167896	6"	9,3	12,5		233	234	232	227	217	203	183	158	128	111	2 1/2"	40	1782		
SS6A 26	60167897	6"	9,3	12,5		243	244	242	236	226	211	190	165	133	116	2 1/2"	41	1842		
SS6A 27	60167898	6"	11	15		252	253	251	245	235	219	198	171	138	120	2 1/2"	43	1903		
SS6A 28	60167899	6"	11	15		261	262	260	254	243	227	205	177	143	124	2 1/2"	44	1963		
SS6A 29	60167900	6"	11	15		270	272	270	263	252	235	212	184	149	129	2 1/2"	46	2024		
SS6A 30	60167901	6"	11	15		280	281	279	272	261	243	220	190	154	133	2 1/2"	47	2084		
SS6A 31	60167902	6"	13	17,5		289	290	288	281	269	251	227	196	159	138	2 1/2"	49	2145		
SS6A 32	60167903	6"	13	17,5		298	300	297	290	278	259	234	202	164	142	2 1/2"	50	2205		
SS6A 33	60167904	6"	13	17,5		308	309	307	300	287	268	242	209	169	147	2 1/2"	52	2266		
SS6A 34	60167905	6"	13	17,5		317	318	316	309	295	276	249	215	174	151	2 1/2"	53	2326		
SS6A 35	60167906	6"	13	17,5		326	328	325	318	304	284	256	221	179	156	2 1/2"	54	2387		
SS6A 36	60167907	6"	13	17,5		336	337	335	327	313	292	264	228	184	160	2 1/2"	56	2447		
SS6A 37	60167908	6"	13	17,5		345	347	344	336	321	300	271	234	190	164	2 1/2"	57	2508		
SS6A 38	60167909	6"	15	20		354	356	353	345	330	308	278	240	195	169	2 1/2"	59	2568		
SS6A 39	60167910	6"	15	20		364	365	362	354	339	316	286	247	200	173	2 1/2"	91	2879		
SS6A 40	60167911	6"	15	20		373	375	372	363	348	324	293	253	205	178	2 1/2"	92	2939		
SS6A 41	60167912	6"	15	20		382	384	381	372	356	332	300	259	210	182	2 1/2"	94	3000		
SS6A 42	60167913	6"	18,5	25		392	393	390	381	365	341	308	266	215	187	2 1/2"	96	3060		
SS6A 43	60167914	6"	18,5	25		401	403	400	390	374	349	315	272	220	191	2 1/2"	98	3121		
SS6A 44	60167915	6"	18,5	25		410	412	409	399	382	357	322	278	225	196	2 1/2"	100	3181		
SS6A 45	60167916	6"	18,5	25		420	421	418	408	391	365	330	285	231	200	2 1/2"	101	3242		
SS6A 46	60167917	6"	18,5	25		429	431	428	418	400	373	337	291	236	204	2 1/2"	103	3302		
SS6A 47	60167918	6"	18,5	25		438	440	437	427	408	381	344	297	241	209	2 1/2"	105	3363		
SS6A 48	60167919	6"	18,5	25		448	450	446	436	417	389	352	304	246	213	2 1/2"	107	3423		
SS6A 49	60167920	6"	18,5	25		457	459	455	445	426	397	359	310	251	218	2 1/2"	108	3484		
SS6A 50	60169215	6"	22	30		466	468	465	454	434	405	366	316	256	222	2 1/2"	110	3544		
SS6A 51	60169216	6"	22	30		476	478	474	463	443	414	373	323	261	227	2 1/2"	112	3605		
SS6A 52	60169217	6"	22	30		485	487	483	472	452	422	381	329	266	231	2 1/2"	114	3665		
SS6A 53	60169218	6"	22	30		494	496	493	481	460	430	388	335	272	236	2 1/2"	116	3726		
SS6A 54	60169219	6"	22	30		504	506	502	490	469	438	395	342	277	240	2 1/2"	117	3786		
SS6A 55	60169220	6"	22	30		513	515	511	499	478	446	403	348	282	244	2 1/2"	119	3847		
SS6A 56	60169221	6"	22	30		522	524	520	508	487	454	410	354	287	249	2 1/2"	121	3907		
SS6A 57	60169223	6"	22	30		532	534	530	517	495	462	417	361	292	253	2 1/2"	123	3968		
SS6A 58	60169225	6"	22	30		541	543	539	526	504	470	425	367	297	258	2 1/2"	125	4028		
SS6A 59	60169227	6"	22	30		550	553	548	536	513	478	432	373	302	262	2 1/2"	126	4089		
SS6A 60	60169228	6"	22	30		560	562	558	545	521	486	439	380	307	267	2 1/2"	128	4149		



D+CONNECT  
 COMMAND AND CONTROL SYSTEMS  
 CIRCULATORS AND IN-LINE PUMPS  
 MULTISTAGE CENTRIFUGAL AND SELF-PRIMING PUMPS  
 SWIMMING POOL, POND AND SALT WATER PUMPS  
 CENTRIFUGAL PUMPS  
 SUBMERSIBLE PUMPS  
 SUBMERSIBLE PUMPS AND SUBMERSIBLE MOTORS  
 PRESSURE UNITS



# SS6

6" SUBMERSIBLE PUMPS



## SS6B HYDRAULIC PART

MODEL	HYDRAULIC PART CODE	MOTOR COUPLING	ELECTRICAL DATA		HYDRAULIC DATA													DNM GAS	WEIGHT KG	H mm
			P2 NOMINAL REQUESTED		Q=m³/h	0,0	6,0	8,0	10,0	12,0	14,0	15,0	16,0	18,0	20,0					
			KW	HP	Q=l/sec	0,0	1,7	2,2	2,8	3,3	3,9	4,2	4,4	5,0	5,6					
SS6B 01	60170130	4"	0,75	1	H (m)	11	11	11	10	10	9	9	9	8	6	2 1/2"	13,1	330		
SS6B 02	60170131	4"	1,5	2		23	22	22	21	20	19	18	17	15	13	2 1/2"	18	390		
SS6B 03	60170132	4"	2,2	3		34	33	33	31	30	28	27	26	23	19	2 1/2"	21,2	451		
SS6B 04	60170133	4"	3	4		45	44	43	42	40	37	36	34	30	26	2 1/2"	29,9	511		
SS6B 05	60170144	4"	3	4		56	55	54	52	50	47	45	43	38	32	2 1/2"	30,9	572		
SS6B 06	60170145	4"	4	5,5		68	66	65	63	60	56	54	51	45	39	2 1/2"	52,4	632		
SS6B 06	60167925	6"	4	5,5		68	66	65	63	60	56	54	51	45	39	2 1/2"	52,4	632		
SS6B 07	60170146	4"	4	5,5		79	77	76	73	70	65	63	60	53	45	2 1/2"	14	693		
SS6B 07	60167199	6"	4	5,5		79	77	76	73	70	65	63	60	53	45	2 1/2"	14	693		
SS6B 08	60170147	4"	5,5	7,5		90	89	87	84	80	75	71	68	60	52	2 1/2"	16	753		
SS6B 08	60167926	6"	5,5	7,5		90	89	87	84	80	75	71	68	60	52	2 1/2"	16	753		
SS6B 09	60170148	4"	5,5	7,5		102	100	98	94	90	84	80	77	68	58	2 1/2"	17	814		
SS6B 09	60167927	6"	5,5	7,5		102	100	98	94	90	84	80	77	68	58	2 1/2"	17	814		
SS6B 10	60170149	4"	5,5	7,5		113	111	108	105	100	93	89	85	76	65	2 1/2"	18	874		
SS6B 10	60167200	6"	5,5	7,5		113	111	108	105	100	93	89	85	76	65	2 1/2"	18	874		
SS6B 11	60170150	4"	7,5	10		124	122	119	115	110	102	98	94	83	71	2 1/2"	20	935		
SS6B 11	60167928	6"	7,5	10		124	122	119	115	110	102	98	94	83	71	2 1/2"	20	935		
SS6B 12	60170151	4"	7,5	10		135	133	130	126	120	112	107	102	91	78	2 1/2"	21	995		
SS6B 12	60167929	6"	7,5	10		135	133	130	126	120	112	107	102	91	78	2 1/2"	21	995		
SS6B 13	60170152	4"	7,5	10		147	144	141	136	130	121	116	111	98	84	2 1/2"	23	1056		
SS6B 13	60167201	6"	7,5	10		147	144	141	136	130	121	116	111	98	84	2 1/2"	23	1056		
SS6B 14	60170153	4"	7,5	10		158	155	152	147	140	130	125	119	106	91	2 1/2"	24	1116		
SS6B 14	60167930	6"	7,5	10		158	155	152	147	140	130	125	119	106	91	2 1/2"	24	1116		
SS6B 15	60167202	6"	9,3	12,5		169	166	163	157	150	140	134	128	113	97	2 1/2"	26	1177		
SS6B 16	60167931	6"	9,3	12,5		181	177	173	168	160	149	143	136	121	103	2 1/2"	27	1237		
SS6B 17	60167203	6"	9,3	12,5		192	188	184	178	170	158	152	145	128	110	2 1/2"	29	1298		
SS6B 18	60167932	6"	11	15		203	199	195	189	180	168	161	153	136	116	2 1/2"	30	1358		
SS6B 19	60167933	6"	11	15		214	210	206	199	190	177	170	162	143	123	2 1/2"	31	1419		
SS6B 20	60167204	6"	11	15		226	221	217	210	199	186	179	170	151	129	2 1/2"	33	1479		
SS6B 21	60167934	6"	15	20		237	232	228	220	209	196	188	179	159	136	2 1/2"	34	1540		
SS6B 22	60167205	6"	15	20	248	243	238	230	219	205	196	187	166	142	2 1/2"	36	1600			
SS6B 23	60167935	6"	15	20	260	254	249	241	229	214	205	196	174	149	2 1/2"	37	1661			
SS6B 24	60167206	6"	15	20	271	266	260	251	239	224	214	204	181	155	2 1/2"	39	1721			
SS6B 25	60167938	6"	15	20	282	277	271	262	249	233	223	213	189	162	2 1/2"	40	1782			
SS6B 26	60167939	6"	15	20	293	288	282	272	259	242	232	221	196	168	2 1/2"	42	1842			
SS6B 27	60167207	6"	15	20	305	299	293	283	269	252	241	230	204	175	2 1/2"	43	1903			
SS6B 28	60167940	6"	15	20	316	310	303	293	279	261	250	238	211	181	2 1/2"	45	1963			
SS6B 29	60167941	6"	18,5	25	327	321	314	304	289	270	259	247	219	188	2 1/2"	46	2024			
SS6B 30	60167208	6"	18,5	25	339	332	325	314	299	280	268	255	227	194	2 1/2"	47	2084			

D+CONNECT  
 COMMAND AND CONTROL SYSTEMS  
 CIRCULATORS AND IN-LINE PUMPS  
 MULTISTAGE CENTRIFUGAL AND SELF-PRIMING PUMPS  
 SWIMMING POOL, POND AND SALT WATER PUMPS  
 CENTRIFUGAL PUMPS  
 SUBMERSIBLE PUMPS  
 SUBMERSIBLE PUMPS AND SUBMERSIBLE MOTORS  
 PRESSURE UNITS

## SS6

6" SUBMERSIBLE PUMPS



## SS6B HYDRAULIC PART

MODEL	HYDRAULIC PART CODE	MOTOR COUPLING	ELECTRICAL DATA		HYDRAULIC DATA												DNM GAS	WEIGHT KG	H mm
			P2 NOMINAL REQUESTED		Q=m³h	0,0	6,0	8,0	10,0	12,0	14,0	15,0	16,0	18,0	20,0				
			kW	HP	Q=l/sec	0,0	1,7	2,2	2,8	3,3	3,9	4,2	4,4	5,0	5,6				
SS6B 31	60167209	6"	18,5	25	H (mt)	350	343	336	325	309	289	277	264	234	200	2 1/2"	49	2145	
SS6B 32	60167942	6"	18,5	25		361	354	347	335	319	298	286	272	242	207	2 1/2"	50	2205	
SS6B 33	60167210	6"	18,5	25		372	365	358	346	329	307	295	281	249	213	2 1/2"	52	2266	
SS6B 34	60167943	6"	18,5	25		384	376	368	356	339	317	304	289	257	220	2 1/2"	53	2326	
SS6B 35	60167944	6"	22	30		395	387	379	367	349	326	313	298	264	226	2 1/2"	55	2387	
SS6B 36	60167211	6"	22	30		406	398	390	377	359	335	322	306	272	233	2 1/2"	56	2447	
SS6B 37	60167945	6"	22	30		418	409	401	388	369	345	330	315	279	239	2 1/2"	58	2508	
SS6B 38	60167212	6"	22	30		429	420	412	398	379	354	339	323	287	246	2 1/2"	59	2568	
SS6B 39	60167946	6"	22	30		440	432	423	409	389	363	348	332	294	252	2 1/2"	91	2879	
SS6B 40	60167213	6"	22	30		451	443	433	419	399	373	357	340	302	259	2 1/2"	93	2939	
SS6B 41	60167947	6"	22	30		463	454	444	430	409	382	366	349	310	265	2 1/2"	95	3000	
SS6B 42	60167948	6"	30	40		474	465	455	440	419	391	375	357	317	272	2 1/2"	96	3060	
SS6B 43	60167949	6"	30	40		485	476	466	450	429	401	384	366	325	278	2 1/2"	98	3121	
SS6B 44	60167950	6"	30	40		497	487	477	461	439	410	393	374	332	284	2 1/2"	100	3181	
SS6B 45	60167951	6"	30	40		508	498	488	471	449	419	402	383	340	291	2 1/2"	102	3242	
SS6B 46	60167952	6"	30	40		519	509	498	482	459	429	411	391	347	297	2 1/2"	103	3302	
SS6B 47	60167953	6"	30	40		531	520	509	492	469	438	420	400	355	304	2 1/2"	105	3363	
SS6B 48	60167954	6"	30	40		542	531	520	503	479	447	429	408	362	310	2 1/2"	107	3423	
SS6B 49	60167955	6"	30	40		553	542	531	513	489	457	438	417	370	317	2 1/2"	109	3484	
SS6B 50	60167956	6"	30	40		564	553	542	524	499	466	447	425	378	323	2 1/2"	111	3544	
SS6B 51	60167957	6"	30	40		576	564	553	534	509	475	456	434	385	330	2 1/2"	112	3605	
SS6B 52	60167958	6"	30	40		587	575	563	545	519	485	464	442	393	336	2 1/2"	114	3665	
SS6B 53	60167959	6"	30	40		598	586	574	555	529	494	473	451	400	343	2 1/2"	116	3726	
SS6B 54	60169229	6"	30	40		610	597	585	566	539	503	482	459	408	349	2 1/2"	118	3786	
SS6B 55	60169236	6"	30	40		621	609	596	576	549	512	491	468	415	356	2 1/2"	120	3847	
SS6B 56	60169237	6"	30	40		632	620	607	587	559	522	500	476	423	362	2 1/2"	121	3907	
SS6B 57	60169238	6"	37	50		643	631	618	597	569	531	509	485	430	369	2 1/2"	123	3968	
SS6B 58	60169239	6"	37	50		655	642	628	608	578	540	518	493	438	375	2 1/2"	125	4028	
SS6B 59	60169240	6"	37	50		666	653	639	618	588	550	527	502	446	381	2 1/2"	127	4089	
SS6B 60	60169241	6"	37	50		677	664	650	629	598	559	536	510	453	388	2 1/2"	129	4149	

COMMAND AND CONTROL SYSTEMS

CIRCULATORS AND IN-LINE PUMPS

MULTISTAGE CENTRIFUGAL AND SELF-PRIMING PUMPS

SWIMMING POOL, POND AND SALT WATER PUMPS

CENTRIFUGAL PUMPS

SUBMERSIBLE PUMPS

SUBMERSIBLE PUMPS AND SUBMERSIBLE MOTORS

PRESSURE UNITS

# SS6

6" SUBMERSIBLE PUMPS



## SS6C HYDRAULIC PART

MODEL	HYDRAULIC PART CODE	MOTOR COUPLING	ELECTRICAL DATA		HYDRAULIC DATA											DNM GAS	WEIGHT KG	H mm
			P2 NOMINAL REQUESTED		Q=m³h	0,0	6,0	10,0	14,0	18,0	22,0	26,0	30,0	34,0	38,0			
			kW	HP	Q=l/sec	0,0	1,7	2,8	3,9	5,0	6,1	7,2	8,3	9,4	10,6			
SS6C 01	60170154	4"	1,1	1,5		12	11	11	11	10	9	8	7	6	5	3"	6	364
SS6C 02	60170155	4"	2,2	3		12	11	11	11	10	9	8	7	6	5	3"	9	459
SS6C 03	60170156	4"	3	4		35	34	33	32	30	28	25	22	19	15	3"	11	554
SS6C 04	60170157	4"	4	5,5		47	46	44	43	40	37	34	30	25	20	3"	13	649
SS6C 04	60167215	6"	4	5,5		47	46	44	43	40	37	34	30	25	20	3"	13	649
SS6C 05	60170158	4"	5,5	7,5		59	57	55	53	50	47	42	37	32	25	3"	15	744
SS6C 05	60167216	6"	5,5	7,5		59	57	55	53	50	47	42	37	32	25	3"	15	744
SS6C 06	60170159	4"	5,5	7,5		70	69	67	64	60	56	51	45	38	30	3"	17	839
SS6C 06	60167217	6"	5,5	7,5		70	69	67	64	60	56	51	45	38	30	3"	17	839
SS6C 07	60170160	4"	7,5	10		82	80	78	74	70	65	59	52	44	35	3"	19	934
SS6C 07	60167962	6"	7,5	10		82	80	78	74	70	65	59	52	44	35	3"	19	934
SS6C 08	60170161	4"	7,5	10		94	92	89	85	80	75	68	60	51	40	3"	21	1029
SS6C 08	60167218	6"	7,5	10		94	92	89	85	80	75	68	60	51	40	3"	21	1029
SS6C 09	60167963	6"	9,2	12,5		105	103	100	96	90	84	76	67	57	45	3"	23	1124
SS6C 10	60167964	6"	9,2	12,5		117	114	111	106	100	93	85	75	63	50	3"	25	1219
SS6C 11	60167219	6"	9,2	12,5		129	126	122	117	110	103	93	82	70	55	3"	27	1314
SS6C 12	60167965	6"	11	15		141	137	133	128	120	112	102	90	76	60	3"	29	1409
SS6C 13	60167220	6"	11	15		152	149	144	138	131	121	110	97	82	65	3"	31	1504
SS6C 14	60167966	6"	15	20		164	160	155	149	141	131	119	105	89	70	3"	33	1599
SS6C 15	60167221	6"	15	20		176	172	166	159	151	140	127	112	95	75	3"	36	1694
SS6C 16	60167967	6"	15	20		187	183	178	170	161	149	136	120	101	80	3"	38	1789
SS6C 17	60167222	6"	15	20		199	195	189	181	171	159	144	127	108	85	3"	40	1884
SS6C 18	60167968	6"	18,5	25		211	206	200	191	181	168	153	135	114	90	3"	42	1979
SS6C 19	60167223	6"	18,5	25		223	217	211	202	191	177	161	142	121	95	3"	44	2074
SS6C 20	60167225	6"	18,5	25		234	229	222	213	201	186	170	150	127	100	3"	46	2169
SS6C 21	60167226	6"	18,5	25		246	240	233	223	211	196	178	157	133	105	3"	48	2264
SS6C 22	60167969	6"	22	30		258	252	244	234	221	205	187	165	140	110	3"	50	2359
SS6C 23	60167227	6"	22	30		269	263	255	244	231	214	195	172	146	115	3"	52	2454
SS6C 24	60167970	6"	22	30		281	275	266	255	241	224	203	180	152	120	3"	54	2549
SS6C 25	60167971	6"	22	30		293	286	277	266	251	233	212	187	159	125	3"	56	2644
SS6C 26	60167228	6"	22	30		305	298	289	276	261	242	220	195	165	130	3"	58	2739
SS6C 27	60167972	6"	30	40		316	309	300	287	271	252	229	202	171	136	3"	60	2834
SS6C 28	60167973	6"	30	40		328	320	311	298	281	261	237	210	178	141	3"	63	2929
SS6C 29	60167974	6"	30	40		340	332	322	308	291	270	246	217	184	146	3"	65	3024
SS6C 30	60167229	6"	30	40		351	343	333	319	301	280	254	225	190	151	3"	67	3119
SS6C 31	60167975	6"	30	40		363	355	344	330	311	289	263	232	197	156	3"	69	3214
SS6C 32	60167976	6"	30	40		375	366	355	340	321	298	271	240	203	161	3"	71	3309
SS6C 33	60167977	6"	30	40		387	378	366	351	331	308	280	247	209	166	3"	73	3404
SS6C 34	60167230	6"	30	40		398	389	377	361	341	317	288	255	216	171	3"	75	3499
SS6C 35	60167978	6"	30	40		410	401	388	372	351	326	297	262	222	176	3"	77	3594
SS6C 36	60167979	6"	30	40		422	412	400	383	361	336	305	270	228	181	3"	79	3689
SS6C 37	60167980	6"	30	40		433	423	411	393	371	345	314	277	235	186	3"	81	3784
SS6C 38	60167981	6"	30	40		445	435	422	404	381	354	322	285	241	191	3"	83	3879
SS6C 39	60167231	6"	37	50		457	446	433	415	392	364	331	292	247	196	3"	124	4224
SS6C 40	60167982	6"	37	50		469	458	444	425	402	373	339	300	254	201	3"	126	4319
SS6C 41	60167983	6"	37	50		480	469	455	436	412	382	348	307	260	206	3"	129	4414
SS6C 42	60167984	6"	37	50		492	481	466	446	422	392	356	315	266	211	3"	132	4509
SS6C 43	60167232	8"	45	60		504	492	477	457	432	401	365	322	273	216	3"	134	4604
SS6C 44	60167985	8"	45	60		515	504	488	468	442	410	373	330	279	221	3"	137	4699
SS6C 45	60167986	8"	45	60		527	515	499	478	452	420	381	337	285	226	3"	139	4794
SS6C 46	60167233	8"	45	60		539	526	511	489	462	429	390	344	292	231	3"	142	4889
SS6C 47	60167988	8"	45	60		551	538	522	500	472	438	398	352	298	236	3"	145	4984
SS6C 48	60167989	8"	45	60		562	549	533	510	482	448	407	359	304	241	3"	147	5079
SS6C 49	60167503	8"	45	60		574	561	544	521	492	457	415	367	311	246	3"	150	5174
SS6C 50	60169242	8"	45	60		586	572	555	532	502	466	424	374	317	251	3"	152	5269
SS6C 51	60169243	8"	45	60		597	584	566	542	512	476	432	382	323	256	3"	155	5364
SS6C 52	60169244	8"	55	75		609	595	577	553	522	485	441	389	330	261	3"	158	5459
SS6C 53	60169245	8"	55	75		621	607	588	563	532	494	449	397	336	266	3"	160	5554
SS6C 54	60169246	8"	55	75		633	618	599	574	542	503	458	404	342	271	3"	163	5649



D+CONNECT  
 COMMAND AND CONTROL SYSTEMS  
 CIRCULATORS AND IN-LINE PUMPS  
 MULTISTAGE CENTRIFUGAL AND SELF-PRIMING PUMPS  
 SWIMMING POOL, POND AND SALT WATER PUMPS  
 CENTRIFUGAL PUMPS  
 SUBMERSIBLE PUMPS  
 SUBMERSIBLE PUMPS AND SUBMERSIBLE MOTORS  
 PRESSURE UNITS

## SS6

6" SUBMERSIBLE PUMPS



## SS6D HYDRAULIC PART

MODEL	HYDRAULIC PART CODE	MOTOR COUPLING	ELECTRICAL DATA		HYDRAULIC DATA													DNM GAS	WEIGHT KG	H mm
			P2 NOMINAL REQUESTED		Q=m³/h	0,0	20,0	25,0	30,0	35,0	40,0	45,0	50,0	55,0	60,0					
			KW	HP	Q=l/sec	0,0	5,6	6,9	8,3	9,7	11,1	12,5	13,9	15,3	16,7					
SS6D 01	60170162	4"	2,2	3	H (m)	14	13	12	11	10	10	9	8	7	5	4"	7	382		
SS6D 02	60170163	4"	4	5,5		28	25	24	22	21	19	18	16	14	10	4"	10	494		
SS6D 02	60167245	6"	4	5,5		28	25	24	22	21	19	18	16	14	10	4"	10	494		
SS6D 03	60170164	4"	5,5	7,5		42	38	36	33	31	29	26	24	20	16	4"	12	606		
SS6D 03	60167246	6"	5,5	7,5		42	38	36	33	31	29	26	24	20	16	4"	12	606		
SS6D 04	60170165	4"	7,5	10		56	50	47	44	41	38	35	32	27	21	4"	15	718		
SS6D 04	60167247	6"	7,5	10		56	50	47	44	41	38	35	32	27	21	4"	15	718		
SS6D 05	60170166	4"	7,5	10		70	63	59	56	52	48	44	39	34	26	4"	18	830		
SS6D 05	60167248	6"	7,5	10		70	63	59	56	52	48	44	39	34	26	4"	18	830		
SS6D 06	60167249	6"	9,2	12,5		84	75	71	67	62	57	53	47	41	31	4"	20	942		
SS6D 07	60167250	6"	11	15		98	88	83	78	72	67	61	55	47	36	4"	23	1054		
SS6D 08	60167251	6"	15	20		112	101	95	89	83	77	70	63	54	42	4"	26	1166		
SS6D 09	60167252	6"	15	20		126	113	107	100	93	86	79	71	61	47	4"	28	1278		
SS6D 10	60167987	6"	18,5	25		140	126	119	111	103	96	88	79	68	52	4"	31	1390		
SS6D 11	60167253	6"	18,5	25		154	138	130	122	114	105	97	87	74	57	4"	34	1502		
SS6D 12	60167254	6"	22	30		168	151	142	133	124	115	105	95	81	62	4"	36	1614		
SS6D 13	60167990	6"	22	30		182	163	154	144	134	125	114	102	88	68	4"	39	1726		
SS6D 14	60167255	6"	22	30		196	176	166	155	145	134	123	110	95	73	4"	42	1838		
SS6D 15	60167991	6"	30	40		210	188	178	167	155	144	132	118	101	78	4"	44	1950		
SS6D 16	60167256	6"	30	40		224	201	190	178	165	153	141	126	108	83	4"	47	2062		
SS6D 17	60167992	6"	30	40		238	214	202	189	176	163	149	134	115	88	4"	49	2174		
SS6D 18	60167257	6"	30	40		252	226	213	200	186	172	158	142	122	93	4"	52	2286		
SS6D 19	60167995	6"	37	50		266	239	225	211	197	182	167	150	128	99	4"	55	2398		
SS6D 20	60167996	6"	37	50		280	251	237	222	207	192	176	158	135	104	4"	57	2510		
SS6D 21	60167997	6"	37	50		294	264	249	233	217	201	184	166	142	109	4"	60	2622		
SS6D 22	60167998	6"	37	50		308	276	261	244	228	211	193	173	149	114	4"	63	2734		
SS6D 23	60167258	6"	37	50		322	289	273	255	238	220	202	181	155	119	4"	65	2846		
SS6D 24	60167999	6"	45	60		336	302	285	267	248	230	211	189	162	125	4"	68	2958		
SS6D 25	60168000	8"	45	60		350	314	296	278	259	239	220	197	169	130	4"	71	3070		
SS6D 26	60167259	8"	45	60		364	327	308	289	269	249	228	205	176	135	4"	73	3182		
SS6D 27	60168001	8"	45	60		378	339	320	300	279	259	237	213	182	140	4"	76	3294		
SS6D 28	60167260	8"	45	60		392	352	332	311	290	268	246	221	189	145	4"	79	3406		
SS6D 29	60168002	8"	45	60		406	364	344	322	300	278	255	229	196	151	4"	81	3518		
SS6D 30	60167261	8"	45	60	420	377	356	333	310	287	264	237	203	156	4"	84	3630			
SS6D 31	60168003	8"	55	75	434	390	368	344	321	297	272	244	209	161	4"	86	3742			
SS6D 32	60168004	8"	55	75	448	402	379	355	331	307	281	252	216	166	4"	89	3854			
SS6D 33	60167262	8"	55	75	462	415	391	366	341	316	290	260	223	171	4"	92	3966			

COMMAND AND CONTROL SYSTEMS

CIRCULATORS AND IN-LINE PUMPS

MULTISTAGE CENTRIFUGAL AND SELF-PRIMING PUMPS

SWIMMING POOL, POND AND SALT WATER PUMPS

CENTRIFUGAL PUMPS

SUBMERSIBLE PUMPS

SUBMERSIBLE PUMPS AND SUBMERSIBLE MOTORS

PRESSURE UNITS

## SS6

6" SUBMERSIBLE PUMPS



## SS6E HYDRAULIC PART

MODEL	HYDRAULIC PART CODE	MOTOR COUPLING	ELECTRICAL DATA		HYDRAULIC DATA													DNM GAS	WEIGHT KG	H mm
			P2 NOMINAL REQUESTED		Q=m³/h	0,0	20,0	40,0	45,0	50,0	55,0	60,0	65,0	70,0	75,0					
			KW	HP	Q=l/sec	0,0	5,6	11,1	12,5	13,9	15,3	16,7	18,1	19,4	20,8					
SS6E 01	60171006	4"	2,2	3	H (m)	15	13	10	10	9	9	8	8	7	6	4"	7	382		
SS6E 02	60171007	4"	4	5,5		30	26	21	20	19	18	17	15	14	11	4"	10	494		
SS6E 02	60167265	6"	4	5,5		30	26	21	20	19	18	17	15	14	11	4"	10	494		
SS6E 03	60171008	4"	5,5	7,5		45	38	31	30	28	27	25	23	20	17	4"	12	606		
SS6E 03	60167266	6"	5,5	7,5		45	38	31	30	28	27	25	23	20	17	4"	12	606		
SS6E 04	60171009	4"	7,5	10		60	51	42	40	38	36	33	31	27	23	4"	15	718		
SS6E 04	60167267	6"	7,5	10		60	51	42	40	38	36	33	31	27	23	4"	15	718		
SS6E 05	60167268	6"	9,2	12,5		75	64	52	50	47	45	42	38	34	28	4"	18	830		
SS6E 06	60167269	6"	11	15		90	77	62	59	57	54	50	46	41	34	4"	20	942		
SS6E 07	60167270	6"	15	20		105	90	73	69	66	63	59	54	48	40	4"	23	1054		
SS6E 08	60167271	6"	15	20		120	103	83	79	75	71	67	61	54	45	4"	26	1166		
SS6E 09	60168005	6"	18,5	25		135	115	94	89	85	80	75	69	61	51	4"	28	1278		
SS6E 10	60167272	6"	18,5	25		150	128	104	99	94	89	84	77	68	56	4"	31	1390		
SS6E 11	60168006	6"	22	30		165	141	115	109	104	98	92	85	75	62	4"	34	1502		
SS6E 12	60167273	6"	22	30		180	154	125	119	113	107	100	92	82	68	4"	36	1614		
SS6E 13	60168007	6"	30	35		195	167	135	129	123	116	109	100	88	73	4"	39	1726		
SS6E 14	60167274	6"	30	35		210	180	146	139	132	125	117	108	95	79	4"	42	1838		
SS6E 15	60168008	6"	30	40		225	192	156	149	141	134	126	115	102	85	4"	44	1950		
SS6E 16	60168009	6"	30	40		240	205	167	159	151	143	134	123	109	90	4"	47	2062		
SS6E 17	60167275	6"	30	40		255	218	177	169	160	152	142	131	116	96	4"	50	2174		
SS6E 18	60168010	6"	37	50		270	231	187	178	170	161	151	138	122	102	4"	52	2286		
SS6E 19	60168011	6"	37	50		285	244	198	188	179	170	159	146	129	107	4"	55	2398		
SS6E 20	60167276	6"	37	50		300	257	208	198	189	179	167	154	136	113	4"	58	2510		
SS6E 21	60167277	6"	37	50		315	269	219	208	198	188	176	161	143	119	4"	60	2622		
SS6E 22	60168012	6"	45	60		330	282	229	218	207	197	184	169	150	124	4"	63	2734		
SS6E 23	60168013	8"	45	60		345	295	239	228	217	205	193	177	157	130	4"	65	2846		
SS6E 24	60167278	8"	45	60		360	308	250	238	226	214	201	184	163	135	4"	68	2958		
SS6E 25	60168014	8"	55	75		375	321	260	248	236	223	209	192	170	141	4"	71	3070		
SS6E 26	60168015	8"	55	75		390	334	271	258	245	232	218	200	177	147	4"	73	3182		
SS6E 27	60168016	8"	55	75		405	346	281	268	255	241	226	208	184	152	4"	76	3294		
SS6E 28	60167279	8"	55	75	420	359	292	278	264	250	234	215	191	158	4"	79	3406			
SS6E 29	60168017	8"	55	75	435	372	302	287	273	259	243	223	197	164	4"	81	3518			
SS6E 30	60167280	8"	55	75	450	385	312	297	283	268	251	231	204	169	4"	84	3630			

COMMAND AND CONTROL SYSTEMS

CIRCULATORS AND IN-LINE PUMPS

MULTISTAGE CENTRIFUGAL AND SELF-PRIMING PUMPS

SWIMMING POOL, POND AND SALT WATER PUMPS

CENTRIFUGAL PUMPS

SUBMERSIBLE PUMPS

SUBMERSIBLE PUMPS AND SUBMERSIBLE MOTORS

PRESSURE UNITS

# SS7

## 7" SUBMERSIBLE PUMPS



Multistage semiaxial submersible electric pumps for wells measuring 7" or above, able to generate a broad range of flow rates. These units are used extensively for lifting, distribution, and pressurisation in civil and industrial water systems, filling of booster pumps and tanks, fire-fighting systems and washing of irrigation systems.

Application with clean, non-aggressive water free from solids or abrasive substances.

### Construction features of the pump

Pump body and impellers in pressed AISI 304 stainless steel.  
Pump with check valve of low pressure loss.

### For operation with inverter see the specifications of the coupled motor.

#### On request

- **Pump body:** in pressed AISI 316 stainless steel for use in aggressive water
- **Impellers:** in pressed AISI 316 stainless steel for use in aggressive water

### Performance range

flow up to 110 m<sup>3</sup>/h and max head of 423 m

**Max. quantity of sand/silt** 50g/m<sup>3</sup>

**Max. ambient temperature**

30°C (50°C available on request)

**Outlet connection diameter (inside threaded)**  
5"

Coupling with motors of 6" or 8" depending on the required hydraulic power, and available in standard or stainless steel version:

**6GF:** encapsulated 6" submersible motor.

**TR6:** rewindable 6" submersible motor.

**TR8:** rewindable 8" submersible motor.

ACCESSORIES  
PAG. 319

## SS7A HYDRAULIC PART

MODEL	HYDRAULIC PART CODE	ELECTRICAL DATA		HYDRAULIC DATA												DNM GAS	WEIGHT KG	H mm	MOTOR COUPLING	
		P2 NOMINAL REQUESTED		Q=m <sup>3</sup> h	Q=I/sec															
		kW	HP		0,0	5,6	8,3	11,1	13,9	16,7	19,4	22,2	25,0	27,8						
SS7A 01	60167429	4	5,5	19	19	18	17	16	15	14	12	11	8	5"	26	571	6"			
SS7A 02	60167430	7,5	10	38	37	36	34	32	30	28	25	21	17	5"	30	699	6"			
SS7A 03	60167431	11	15	58	56	54	51	49	45	42	37	32	25	5"	34	827	6"			
SS7A 04	60167432	15	20	77	74	72	69	65	61	56	50	42	33	5"	38	955	6"			
SS7A 05	60167433	18,5	25	96	93	90	86	81	76	69	62	53	41	5"	42	1083	6"			
SS7A 06	60167434	22	30	115	111	108	103	97	91	83	74	63	50	5"	46	1211	6"			
SS7A 07	60168018	26	35	135	130	126	120	114	106	97	87	74	58	5"	50	1339	6"			
SS7A 08	60167435	30	40	154	149	144	137	130	121	111	99	84	66	5"	54	1467	6"			
SS7A 09	60168019	37	50	173	167	161	154	146	136	125	111	95	75	5"	58	1595	6"			
SS7A 10	60167436	37	50	192	186	179	172	162	152	139	124	105	83	5"	62	1723	6"			
SS7A 11	60168025	45	60	211	204	197	189	179	167	153	136	116	91	5"	66	1851	8"			
SS7A 12	60167437	45	60	231	223	215	206	195	182	167	149	127	99	5"	70	1979	8"			
SS7A 13	60168026	55	75	250	241	233	223	211	197	181	161	137	108	5"	74	2107	8"			
SS7A 14	60168027	55	75	269	260	251	240	227	212	195	173	148	116	5"	78	2235	8"			
SS7A 15	60167438	55	75	288	278	269	257	244	227	208	186	158	124	5"	82	2363	8"			
SS7A 16	60168028	63	85	307	297	287	275	260	243	222	198	169	133	5"	86	2491	8"			
SS7A 17	60168029	75	100	327	316	305	292	276	258	236	210	179	141	5"	89	2619	8"			
SS7A 18	60168030	75	100	346	334	323	309	292	273	250	223	190	149	5"	93	2747	8"			
SS7A 19	60168031	75	100	365	353	341	326	309	288	264	235	200	158	5"	97	2875	8"			
SS7A 20	60168032	75	100	384	371	359	343	325	303	278	248	211	166	5"	101	3003	8"			
SS7A 21	60168033	75	100	404	390	377	360	341	318	292	260	221	174	5"	105	3131	8"			
SS7A 22	60168034	92	125	423	408	395	378	357	334	306	272	232	182	5"	109	3259	8"			

# SS7

7" SUBMERSIBLE PUMPS



## SS7B HYDRAULIC PART

MODEL	HYDRAULIC PART CODE	ELECTRICAL DATA		HYDRAULIC DATA												DNM GAS	WEIGHT KG	H mm	MOTOR COUPLING
		P2 NOMINAL REQUESTED		Q=m³h	0,0	20,0	40,0	50,0	60,0	70,0	80,0	90,0	100,0	115,0					
		KW	HP	Q=l/sec	0,0	5,6	11,1	13,9	16,7	19,4	22,2	25,0	27,8	31,9					
SS7B 01	60168045	5,5	7,5	H (mt)	21	21	20	20	19	18	17	16	14	11	5"	26	571	6"	
SS7B 02	60167460	11	15		43	43	41	39	38	36	34	32	28	21	5"	30	699	6"	
SS7B 03	60167461	15	20		64	64	61	59	56	54	51	47	43	32	5"	34	827	6"	
SS7B 04	60168035	22	30		85	86	81	78	75	72	68	63	57	43	5"	38	955	6"	
SS7B 05	60167462	30	40		106	107	101	98	94	90	85	79	71	54	5"	42	1083	6"	
SS7B 06	60167463	37	50		128	128	122	117	113	108	102	95	85	64	5"	46	1211	6"	
SS7B 07	60168036	37	50		149	150	142	137	132	126	119	111	100	75	5"	50	1339	6"	
SS7B 08	60167464	45	60		170	171	162	156	150	144	136	126	114	86	5"	54	1467	8"	
SS7B 09	60168037	45	60		192	193	183	176	169	162	153	142	128	96	5"	58	1595	8"	
SS7B 10	60167482	55	75		213	214	203	196	188	180	170	158	142	107	5"	62	1723	8"	
SS7B 11	60168038	63	85		234	235	223	215	207	197	187	174	157	118	5"	66	1851	8"	
SS7B 12	60167483	75	100		256	257	243	235	225	215	204	190	171	128	5"	70	1979	8"	
SS7B 13	60168039	75	100		277	278	264	254	244	233	221	206	185	139	5"	74	2107	8"	
SS7B 14	60168040	75	100		298	300	284	274	263	251	238	221	199	150	5"	78	2235	8"	
SS7B 15	60168041	92	125		319	321	304	293	282	269	255	237	214	161	5"	82	2363	8"	
SS7B 16	60168042	92	125		341	342	325	313	301	287	272	253	228	171	5"	86	2491	8"	
SS7B 17	60168043	92	125		362	364	345	332	319	305	289	269	242	182	5"	90	2619	8"	
SS7B 18	60168044	110	150		383	385	365	352	338	323	306	285	256	193	5"	94	2747	8"	
SS7B 19	60168046	110	150		405	407	385	372	357	341	323	300	271	203	5"	98	2875	8"	
SS7B 20	60168047	110	150		426	428	406	391	376	359	340	316	285	214	5"	102	3003	8"	

# SS8

## 8" SUBMERSIBLE PUMPS



Multistage **semiaxial** submersible electric pumps for wells measuring 8" or above, able to generate a broad range of flow rates. These units are used extensively for lifting, distribution, and pressurisation in civil and industrial water systems, filling of booster pumps and tanks, fire-fighting systems and washing of irrigation systems.

Application with clean, non-aggressive water free from solids or abrasive substances.

### Construction features of the pump

Pump body and impellers in pressed AISI 304 stainless steel.  
Pump with check valve of low pressure loss.

### For operation with inverter see the specifications of the coupled motor.

#### On request

- **Pump body:** in pressed AISI 316 stainless steel for use in aggressive water
- **Impellers:** in pressed AISI 316 stainless steel for use in aggressive water

### Performance range

flow up to 210 m<sup>3</sup>/h and max head of 555 m

**Max. quantity of sand/silt** 50g/m<sup>3</sup>

### Max. ambient temperature

30°C (50°C available on request)

**Outlet connection diameter (inside threaded)**  
6"

Coupling with motors of 6", 8" or 10" depending on the required hydraulic power, and available in standard or stainless steel version:  
**6GF:** encapsulated 6" submersible motor.  
**TR6:** rewindable 6" submersible motor.  
**TR8:** rewindable 8" submersible motor.  
**TR10:** rewindable 10" submersible motor.

ACCESSORIES  
PAG. 319

## SS8A HYDRAULIC PART

MODEL	HYDRAULIC PART CODE	ELECTRICAL DATA		HYDRAULIC DATA											DNM GAS	WEIGHT KG	H mm	MOTOR COUPLING	
		P2 NOMINAL REQUESTED		Q=m <sup>3</sup> /h	Q=l/sec														
		KW	HP		0,0	8,3	19,4	22,2	25,0	27,8	30,6	33,3	36,1	38,9					
SS8A 01	60168101	7,5	10	H (m)	28	26	23	22	21	20	18	16	15	12	6"	32	686	6"	
SS8A 02	60168102	15	20		56	52	46	44	42	39	36	33	29	24	6"	38	842	6"	
SS8A 03	60168103	22	30		83	78	69	66	63	59	54	49	44	37	6"	45	997	6"	
SS8A 04	60168104	30	40		111	104	91	88	83	78	73	66	58	49	6"	51	1153	6"	
SS8A 05	60168105	37	50		139	129	114	110	104	98	91	82	73	61	6"	57	1309	6"	
SS8A 06	60168106	45	60		167	155	137	131	125	118	109	99	87	73	6"	64	1465	8"	
SS8A 07	60168107	55	75		194	181	160	153	146	137	127	115	102	86	6"	70	1620	8"	
SS8A 08	60168108	63	85		222	207	183	175	167	157	145	132	116	98	6"	76	1776	8"	
SS8A 09	60168109	75	100		250	233	206	197	188	176	163	148	131	110	6"	83	1932	8"	
SS8A 10	60168110	75	100		278	259	229	219	208	196	182	165	145	122	6"	89	2087	8"	
SS8A 11	60168117	92	125		305	285	252	241	229	216	200	181	160	135	6"	95	2243	8"	
SS8A 12	60168118	92	125		333	311	274	263	250	235	218	198	174	147	6"	101	2399	8"	
SS8A 13	60168119	92	125		361	337	297	285	271	255	236	214	189	159	6"	108	2554	8"	
SS8A 14	60168120	110	150		389	362	320	307	292	274	254	231	203	171	6"	114	2710	8"	
SS8A 15	60168121	110	150		416	388	343	329	313	294	272	247	218	184	6"	120	2866	8"	
SS8A 16	60168128	132	180		444	414	366	351	333	313	290	264	232	196	6"	127	3022	10"	
SS8A 17	60168129	132	180		472	440	389	373	354	333	309	280	247	208	6"	133	3177	10"	
SS8A 18	60168130	132	180		500	466	412	394	375	353	327	297	262	220	6"	139	3333	10"	
SS8A 19	60168131	147	200		527	492	435	416	396	372	345	313	276	233	6"	145	3489	10"	
SS8A 20	60168132	147	200		555	518	457	438	417	392	363	330	291	245	6"	152	3644	10"	



# SS8

8" SUBMERSIBLE PUMPS



## SS8B HYDRAULIC PART

MODEL	HYDRAULIC PART CODE	ELECTRICAL DATA		HYDRAULIC DATA											DNM GAS	WEIGHT KG	H mm	MOTOR COUPLING
		P2 NOMINAL REQUESTED		Q=m³h	0,0	40,0	70,0	90,0	120,0	130,0	140,0	150,0	160,0	170,0				
		KW	HP	Q=l/sec	0,0	11,1	19,4	25,0	33,3	36,1	38,9	41,7	44,4	47,2				
SS8B 01.B1	60168135	9,3	12,5	H (mt)	27	25	23	22	19	18	17	16	14	12	6"	32	686	6"
SS8B 01	60168136	11	15		33	31	28	27	24	23	21	19	17	14	6"	32	686	6"
SS8B 02.B2	60168137	18,5	25		54	50	46	44	39	37	34	32	28	24	6"	39	842	6"
SS8B 02	60168138	22	30		65	61	57	53	48	45	42	38	34	29	6"	39	842	6"
SS8B 03.B3	60168139	30	40		80	75	70	66	58	55	52	47	42	35	6"	45	997	6"
SS8B 03	60168140	37	50		98	92	85	80	71	68	63	58	51	43	6"	45	997	6"
SS8B 04	60168142	45	60		131	122	113	107	95	90	84	77	68	58	6"	52	1153	8"
SS8B 05.B3	60168143	55	75		146	136	126	119	106	100	94	86	76	64	6"	58	1309	8"
SS8B 05	60168144	55	75		163	153	142	134	119	113	105	96	85	72	6"	58	1309	8"
SS8B 06	60168149	75	100		196	183	170	160	143	135	126	115	102	87	6"	65	1465	8"
SS8B 07	60168151	75	100		228	214	198	187	166	158	147	135	119	101	6"	71	1620	8"
SS8B 08	60168153	92	125		261	245	227	214	190	180	168	154	136	115	6"	78	1776	8"
SS8B 09	60168154	110	150		294	275	255	240	214	203	189	173	153	130	6"	84	1932	8"
SS8B 10	60168155	110	150	326	306	283	267	238	225	210	192	171	144	6"	91	2087	8"	
SS8B 11	60168156	132	180	359	336	312	294	261	248	231	211	188	159	6"	97	2243	10"	
SS8B 12	60168157	132	180	392	367	340	320	285	270	252	231	205	173	6"	104	2399	10"	
SS8B 13	60168159	147	200	424	397	368	347	309	293	273	250	222	187	6"	110	2554	10"	

## SS8C HYDRAULIC PART

MODEL	HYDRAULIC PART CODE	ELECTRICAL DATA		HYDRAULIC DATA											DNM GAS	WEIGHT KG	H mm	MOTOR COUPLING
		P2 NOMINAL REQUESTED		Q=m³h	0,0	50,0	70,0	90,0	110,0	130,0	150,0	170,0	190,0	210,0				
		KW	HP	Q=l/sec	0,0	13,9	19,4	25,0	30,6	36,1	41,7	47,2	52,8	58,3				
SS8C 01.B1	60169247	9,2	12,5	H (mt)	24	22	21	20	18	17	16	14	12	9	6"	34	686	6"
SS8C 01	60168162	11	15		30	28	26	24	23	22	20	18	15	11	6"	34	686	6"
SS8C 02.B2	60169248	18,5	25		48	44	42	39	37	34	32	28	23	17	6"	40	842	6"
SS8C 02	60168163	22	30		60	55	52	49	46	43	40	35	29	22	6"	40	842	6"
SS8C 03.B2	60169249	30	40		78	72	68	64	60	56	52	46	38	28	6"	47	997	6"
SS8C 03	60168165	37	50		90	83	78	73	69	65	60	53	44	32	6"	47	997	6"
SS8C 04	60168166	45	60		120	111	104	98	92	86	80	71	58	43	6"	53	1153	8"
SS8C 05	60168167	55	75		150	139	130	122	115	108	99	88	73	54	6"	60	1309	8"
SS8C 06.B3	60169462	63	85		162	150	141	132	124	116	107	95	79	58	6"	66	1465	8"
SS8C 06	60168168	75	100		180	166	156	147	138	129	119	106	88	65	6"	66	1465	8"
SS8C 07.B3	60169463	75	100		192	177	167	156	147	138	127	113	94	69	6"	73	1620	8"
SS8C 07	60168169	92	125		210	194	182	171	161	151	139	124	102	76	6"	73	1620	8"
SS8C 08	60168170	92	125		240	222	208	195	184	172	159	141	117	87	6"	79	1776	8"
SS8C 09	60168171	110	150		270	249	234	220	207	194	179	159	132	97	6"	86	1932	8"
SS8C 10	60168172	110	150		300	277	260	244	230	215	199	176	146	108	6"	92	2087	8"
SS8C 11	60168173	132	180		330	305	286	269	253	237	219	194	161	119	6"	99	2243	10"
SS8C 12	60168174	147	200	360	333	312	293	276	259	239	212	175	130	6"	105	2399	10"	
SS8C 13	60168176	147	200	390	360	338	318	299	280	258	229	190	141	6"	112	2554	10"	
SS8C 14	60169464	170	230	420	388	364	342	322	302	278	247	205	152	6"	118	2710	10"	
SS8C 15	60169465	190	260	450	416	390	366	345	323	298	265	219	162	6"	124	2866	10"	
SS8C 16	60169466	190	260	480	443	416	391	368	345	318	282	234	173	6"	131	3022	10"	

# SS10

10" SUBMERSIBLE PUMPS



Multistage **semiaxial** submersible electric pumps for wells measuring 10" or above, able to generate a broad range of flow rates. These units are used extensively for lifting, distribution, and pressurisation in civil and industrial water systems, filling of booster pumps and tanks, fire-fighting systems and washing of irrigation systems.

Application with clean, non-aggressive water free from solids or abrasive substances.

### Construction features of the pump

Pump body and impellers in pressed AISI 304 stainless steel.  
Pump with check valve of low pressure loss.

**For operation with inverter see the specifications of the coupled motor.**

### On request

- **Pump body:** in pressed AISI 316 stainless steel for use in aggressive water.

- **Impellers:** in pressed AISI 316 stainless steel for use in aggressive water



### Performance range

flow up to 290 m<sup>3</sup>/h and max head of 385 m

**Max. quantity of sand/silt** 50g/m<sup>3</sup>

**Max. ambient temperature**

30°C (50°C available on request)

**Outlet connection diameter (inside threaded)**  
6"

Coupling with motors of 6", 8" or 10" depending on the required hydraulic power, and available in standard version or a version completely in stainless steel.

**6GF:** encapsulated 6" submersible motor.

**TR6:** rewindable 6" submersible motor.

**TR8:** rewindable 8" submersible motor.

**TR10:** rewindable 10" submersible motor.

ACCESSORIES  
PAG. 319

## SS10A HYDRAULIC PART

MODEL	HYDRAULIC PART CODE	ELECTRICAL DATA		HYDRAULIC DATA											DNM GAS	WEIGHT KG	H mm	MOTOR COUPLING
		P2 NOMINAL REQUESTED		Q=m <sup>3</sup> h	0,0	50,0	100,0	140,0	180,0	200,0	220,0	240,0	260,0	290,0				
		KW	HP	Q=l/min	0,0	13,9	27,8	38,9	50,0	55,6	61,1	66,7	72,2	80,6				
SS10A 01.B1	60168180	15	20	H (mt)	29	27	25	22	20	19	18	16	15	11	6"	44	794	6"
SS10A 01	60169211	18,5	25		39	36	33	30	27	25	24	22	19	15	6"	44	794	6"
SS10A 02.B2	60169212	30	40		58	54	49	44	40	37	35	32	29	22	6"	55	970	6"
SS10A 02	60168182	37	50		77	72	66	59	53	50	47	44	39	30	6"	55	970	6"
SS10A 03.B3	60169467	45	60		87	81	74	66	59	56	53	49	44	34	6"	66	1147	8"
SS10A 03.B1	60169468	55	75		106	99	91	81	73	69	65	60	53	41	6"	66	1147	8"
SS10A 03	60169469	63	85		116	108	99	89	80	75	71	65	58	45	6"	66	1147	8"
SS10A 04.B2	60169470	75	100		135	126	115	103	93	88	82	76	68	53	6"	76	1323	8"
SS10A 04	60168185	75	100		155	145	132	119	106	100	94	87	78	60	6"	76	1323	8"
SS10A 05	60168186	92	125		194	181	165	148	133	125	118	109	97	75	6"	87	1499	8"
SS10A 06	60168187	110	150	232	217	198	178	159	151	141	131	117	91	6"	98	1675	8"	
SS10A 07	60168188	132	180	271	253	231	207	186	176	165	152	136	106	6"	109	1851	10"	
SS10A 08	60168189	147	200	310	289	264	237	212	201	189	174	156	121	6"	119	2028	10"	
SS10A 09	60168190	170	230	349	325	298	267	239	226	212	196	175	136	6"	130	2204	10"	
SS10A 10	60168191	190	260	387	362	331	296	265	251	236	218	195	151	6"	141	2380	10"	

# SMC6

## 6" SUBMERSIBLE PUMPS



Multistage semiaxial submersible electric pumps for wells measuring 6" or above, able to generate a broad range of flow rates and heads. They are used extensively for the lifting, distribution and pressurisation of industrial water systems, the supply of booster pumps and tanks, firefighting systems and irrigation systems. Application with clean, non-aggressive water free from solids or abrasive substances.

### Construction features of the pump

Cast iron pump body treated with cataphoresis paint coating and dynamically balanced impellers in microcast AISI 304 stainless steel coupled on the shaft with pull tab. Shaft guided with coaxial bush bearings and fully protected with bushes.

Pump with check valve of low pressure loss. Threaded delivery port.

Refer to the technical data sheets of the specific model for the electrical characteristics of the coupled motors and the specifications for operation with inverter.

The SMN version completely in AISI 316 stainless steel is available on request.



### Operating range

up to 84 m<sup>3</sup>/h with head up to 452 m.

**Pumped liquid** clean, free of solids and abrasives, chemically neutral, with properties similar to water.

**Starts/hour** see the coupled motor

**Cooling flow** see the coupled motor

### Maximum permitted amount of sand

40 g/m<sup>3</sup>

**Ambient temperature** 30 °C

### Minimum recommended level on suction

line 1 m

**Installation** horizontal or vertical

Coupling with motors of 4", 6" or 8" depending on the required hydraulic power, and available in standard version or a version completely in stainless steel.

**4GG:** encapsulated 4" submersible motor.

**4OL:** 4" submersible motor in oil bath.

**6GF:** encapsulated 6" submersible motor.

**TR6:** rewindable 6" submersible motor.

**TR8:** rewindable 8" submersible motor.

ACCESSORIES  
PAG. 319

## SMC6 30 HYDRAULIC PART

MODEL	HYDRAULIC PART CODE	ELECTRICAL DATA		HYDRAULIC DATA														DNM GAS	WEIGHT KG	H mm	MOTOR COUPLING
		P2 NOMINAL REQUESTED		Q=m <sup>3</sup> h	0	9	12	15	18	21	24	27	30	33	36	42					
		kW	HP	Q=l/min	0	150	200	250	300	350	400	450	500	550	600	700					
SMC6 30/4E	60177213	5,5	7,5	H (m)	66,5	63	62	60,5	59	57	54,5	51,5	47,5	42,5	36,5	23	2½"	28	634	4"	
SMC6 30/5E	60177214	7,5	10		83	79	77	75,5	73,5	71	68	64	59	53	45	28,5	2½"	33	710	6"	
SMC6 30/7G	60177215	9,3	12,5		113	107,5	105,5	102,5	99	95,5	90	84	76,5	67,5	56,5	32,5	2½"	42	875	6"	
SMC6 30/8E	60177216	11	15		133	126	123,5	120,5	117,5	113,5	108,5	102	94	84	71,5	45	2½"	46	958	6"	
SMC6 30/10F	60177217	13	17,5		161,5	150,5	148	144,5	140,5	136	129	120	109	96	79,5	49	2½"	55	1123	6"	
SMC6 30/11E	60177218	15	20		182,5	171	167,5	164	159,5	154,5	147	137,5	125,5	111	93	58	2½"	60	1205	6"	
SMC6 30/12E	60177219	18,5	25		199,5	186,5	183	178,5	174	168,5	160	149,5	136,5	121	101,5	63,5	2½"	65	1288	6"	
SMC6 30/14E	60177220	18,5	25		232,5	217,5	213,5	208,5	203	196,5	187	174,5	159,5	141	118	73,5	2½"	74	1453	6"	
SMC6 30/15E	60177221	22	30		249	233	228,5	223,5	217,5	210,5	200	187	170,5	151	126,5	79	2½"	78	1535	6"	
SMC6 30/17F	60177222	22	30		274,5	256	251,5	245,5	239	230,5	219	204	185	162,5	135	82	2½"	88	1700	6"	
SMC6 30/20F	60177223	26	35		322,5	304	297,5	290	282	272,5	259	240,5	217,5	189	155	92,5	2½"	101	1948	6"	
SMC6 30/22E	60177224	30	40		361	339	332	325	318	306	291	271,5	246	215	177	106,5	2½"	110	2113	6"	
SMC6 30/25F	60177225	37	50		403	380	372	362,5	352,5	340,5	323,5	301	271,5	236	193,5	115,5	2½"	124	2360	6"	
SMC6 30/28F	60177226	37	50		451,5	425,5	416,5	405,5	394,5	381,5	362	337	304	264,5	216,5	129	2½"	138	2608	6"	

# SMC6

6" SUBMERSIBLE PUMPS



## SMC6 45 HYDRAULIC PART

MODEL	HYDRAULIC PART CODE	ELECTRICAL DATA		HYDRAULIC DATA													DNM GAS	WEIGHT KG	H mm	MOTOR COUPLING
		P2 NOMINAL REQUESTED		Q=m³h	0	12	18	24	30	36	42	45	48	54	60	66				
		KW	HP	Q=l/min	0	200	300	400	500	600	700	750	800	900	1000	1100				
SMC6 45/3H	60177227	4	5,5	H (m)	39	35,5	33,5	32	30,5	28,5	26	24,5	23	18,5	14	9	3"	26	664	4"
SMC6 45/4H	60177228	5,5	7,5		52	47,5	45	43	41	38,5	35	33	30,5	25,5	19	13	3"	31	773	4"
SMC6 45/5G	60177229	7,5	10		70	64	61,5	59,5	57	54	49,5	47	44	37,5	29,5	20	3"	37	888	6"
SMC6 45/6F	60177230	9,2	12,5		85,5	78,5	75	72,5	69,5	66	60,5	57,5	53,5	45	35	24,5	3"	42	1003	6"
SMC6 45/7E	60177231	11	15		101	95,5	92	89	85	80	72,5	68,5	64	53,5	41,5	28,5	3"	47	1118	6"
SMC6 45/8E	60177232	15	20		116	110	106,5	103	99	93	85	80,5	75	63	48	31,5	3"	53	1233	6"
SMC6 45/10F	60177233	15	20		140,5	130	124,5	119,5	114,5	108	99	93,5	87,5	73,5	57	39,5	3"	64	1463	6"
SMC6 45/11F	60177234	18,5	25		154,5	143	137	131,5	125,5	118,5	108,5	102,5	96	80,5	62,5	43,5	3"	69	1578	6"
SMC6 45/12F	60177236	18,5	25		168,5	156	149	143,5	137	129,5	118,5	112	104,5	87,5	68	47	3"	74	1693	6"
SMC6 45/13F	60177237	22	30		182,5	168,5	161,5	155,5	148,5	140	128	121	113	95	73,5	51	3"	80	1808	6"
SMC6 45/14E	60177238	22	30		201,5	190,5	183,5	177	169	159	144,5	136	126,5	105,5	81,5	57	3"	85	1923	6"
SMC6 45/17F	60177239	26	35		238,5	220,5	211	203	194	183	167,5	158	147,5	123,5	95,5	66	3"	101	2268	6"
SMC6 45/20F	60177240	30	40		280,5	259,5	248,5	238,5	228	215	196,5	186	173,5	145,5	112	75	3"	117	2613	6"
SMC6 45/22G	60177241	37	50		308	284,5	274	263	250	234	212,5	200,5	187	157	121	78,5	3"	128	2843	6"
SMC6 45/24F	60177242	37	50		336,5	311	298	286	273,5	258	236	222,5	208	174	134,5	93	3"	139	3073	6"

## SMC6 60 HYDRAULIC PART

MODEL	HYDRAULIC PART CODE	ELECTRICAL DATA		HYDRAULIC DATA													DNM GAS	WEIGHT KG	H mm	MOTOR COUPLING
		P2 NOMINAL REQUESTED		Q=m³h	0	18	30	36	42	48	54	60	66	72	78	84				
		KW	HP	Q=l/min	0	300	500	600	700	800	900	1000	1100	1200	1300	1400				
SMC6 60/2G	60177243	4	5,5	H (m)	26,5	24,5	23,5	22,5	21,5	20	18,5	16	14	11	8	5	3"	21	549	4"
SMC6 60/3G	60177244	5,5	7,5		39,5	37	35,5	34	32,5	30,5	28	24,5	21	17	13	8	3"	26	664	4"
SMC6 60/4G	60177245	7,5	10		52	50,5	48,5	47	45	42	39	34,5	30	25	19,5	13	3"	31	773	6"
SMC6 60/5G	60177246	9,2	12,5		65	63	60,5	58,5	56	52,5	48,5	43	37	31	24	16	3"	37	888	6"
SMC6 60/6G	60177247	11	15		78	75,5	72,5	70	67,5	63	58	51,5	44,5	36,5	28	18,5	3"	42	1003	6"
SMC6 60/7E	60177248	13	17,5		94,5	89	83,5	81	77,5	72,5	67	59,5	51	42	32	22,5	3"	47	1118	6"
SMC6 60/8E	60177249	15	20		108	101,5	95,5	92,5	88,5	83	76,5	68	58,5	47,5	36,5	25,5	3"	53	1233	6"
SMC6 60/9E	60177250	18,5	25		121,5	114	107,5	104	99,5	93	86	76	65,5	53,5	41	28	3"	58	1348	6"
SMC6 60/10E	60177251	18,5	25		135	126,5	119,5	115,5	110,5	103,5	95,5	84,5	72,5	59	45	31	3"	64	1463	6"
SMC6 60/11E	60177252	22	30		148	139,5	131,5	127	121,5	113,5	104,5	93	79,5	65	49,5	34	3"	69	1578	6"
SMC6 60/12E	60177253	22	30		161,5	152	143	138,5	132,5	124	114	101	87	70,5	54	36,5	3"	74	1693	6"
SMC6 60/14E	60177254	26	35		188,5	178,5	169,5	163,5	156,5	146	134	119,5	103,5	85,5	66,5	44,5	3"	85	1923	6"
SMC6 60/16E	60177255	30	40		215,5	204	193,5	187	178,5	166,5	153	136,5	118	97,5	75,5	50,5	3"	96	2153	6"
SMC6 60/18F	60177256	37	50		238	225	213,5	206	196,5	183	167	148,5	128	105	80	52,5	3"	106	2383	6"
SMC6 60/20E	60177257	37	50		269,5	255	242	233,5	223	208	191,5	170	147	121,5	94	62,5	3"	117	2613	6"
SMC6 60/24E	60177258	45	60		323,5	306	290	280	267,5	249,5	229,5	204	176,5	145,5	112	74,5	3"	139	3073	6"

# SMC8

8" SUBMERSIBLE PUMPS



Multistage semiaxial submersible electric pumps for wells measuring 8" or above, able to generate a broad range of flow rates and heads. They are used extensively for the lifting, distribution and pressurisation of industrial water systems, the supply of booster pumps and tanks, firefighting systems and irrigation systems. Application with clean, non-aggressive water free from solids or abrasive substances.

### Construction features of the pump

Cast iron pump body treated with cathaphoresis paint coating and dynamically balanced impellers in microcast AISI 304 stainless steel coupled on the shaft with pull tab. Shaft guided with coaxial bush bearings and fully protected with bushes.

Pump with check valve of low pressure loss. Threaded delivery port.

Refer to the technical data sheets of the specific model for the electrical characteristics of the submersible motors and the specifications for operation with inverter.

The SMN version completely in AISI 316 stainless steel is available on request.



### Operating range

up to 192 m<sup>3</sup>/h with head up to 488 m.

**Pumped liquid** clean, free of solids and abrasives, chemically neutral, with properties similar to water.

**Start-ups/hour** see the coupled motor

**Cooling flow** see the coupled motor

**Maximum permitted amount of sand**  
40 g/m<sup>3</sup>

**Ambient temperature** 30 °C

**Minimum recommended level on suction line**  
1,5 m.

**Installation** horizontal or vertical

Coupling with motors of 6" or 8" depending on the required hydraulic power, and available in standard version or a version completely in stainless steel.

**6GF:** encapsulated 6" submersible motor.

**TR6:** rewindable 6" submersible motor.

**TR8:** rewindable 8" submersible motor.

ACCESSORIES  
PAG. 319

## SMC8 60 HYDRAULIC PART

MODEL	HYDRAULIC PART CODE	ELECTRICAL DATA															DNM	WEIGHT KG	H mm	MOTOR COUPLING
		P2 NOMINAL REQUESTED		HYDRAULIC DATA																
		Q=m <sup>3</sup> /h	0	24	30	36	42	48	54	60	66	72	78	84	90					
SMC8 60/1D	60177259	4	5,5	23,5	20	19,5	19	18,5	18	17	16,5	15	14	12,5	11	9,5	5"	32	551	6"
SMC8 60/2I	60177260	5,5	7,5	38	32,5	31,5	30	28,5	27,5	25,5	23,5	21	17,5	14	10,5	7	5"	42	687	6"
SMC8 60/2F	60177261	7,5	10	47	41	39,5	38,5	37	36	34	32	29,5	27	24	21	18,5	5"	42	687	6"
SMC8 60/3G	60177262	9,3	12,5	62,5	54,5	53,5	52	50	48	45,5	42,5	38,5	33,5	29	24	19	5"	52	823	6"
SMC8 60/3F	60177263	11	15	70	62	60,5	58,5	56	54	51,5	48,5	44,5	40,5	35,5	31,5	26	5"	53	823	6"
SMC8 60/4H	60177264	11	15	79,5	69,5	68	65,5	62	58,5	54,5	50,5	45,5	40	35	28	21,5	5"	63	959	6"
SMC8 60/4G	60177265	13	17,5	83	73	71	69	66,5	64	60,5	56,5	51	45	38,5	32	25,5	5"	63	959	6"
SMC8 60/4F	60177266	15	20	93	82	80	78	75	72	68	64,5	59	53,5	47	41	35	5"	63	959	6"
SMC8 60/5G	60177267	18,5	25	104	91	89	86,5	83	80	76	70,5	64	56	48	40	32	5"	74	1095	6"
SMC8 60/5F	60177268	18,5	25	115	103	100	96,5	93	89	84	79	72,5	65	57	49,5	41,5	5"	74	1095	6"
SMC8 60/6G	60177269	22	30	125	109	107	104	99,5	95,5	91	84,5	76,5	67,5	57,5	48	38,5	5"	84	1231	6"
SMC8 60/6F	60177270	22	30	138	123	120	116	112	107	101	95	86,5	78	68,5	59,5	50	5"	85	1231	6"
SMC8 60/7G	60177271	22	30	146	128	125	121	116	112	106	99	89,5	78,5	67	56	45	5"	95	1367	6"
SMC8 60/8G	60177272	26	35	167	146	144	138	133	128	122	113	102	89,5	77	64	51	5"	105	1503	6"
SMC8 60/8F	60177273	30	40	184	164	160	155	149	142	136	127	116	104	91,5	79,5	66,5	5"	106	1503	6"
SMC8 60/9E	60177274	37	50	207	185	180	174	167	160	152	142	130	117	103	89,5	75	5"	117	1639	6"
SMC8 60/10E	60177277	37	50	230	205	200	194	186	178	169	158	145	130	114	99	83,5	5"	128	1775	6"
SMC8 60/11F	60177278	45	60	253	226	220	213	204	196	185	174	159	143	126	109	92	5"	140	1911	8"
SMC8 60/11D	60177281	45	60	272	241	237	230	221	212	202	189	173	156	136	117	98	5"	140	1911	8"
SMC8 60/12D	60177282	55	75	295	265	259	251	242	234	222	208	191	173	152	132	110	5"	150	2047	8"
SMC8 60/13D	60177283	55	75	321	285	280	272	261	251	238	223	204	184	161	139	117	5"	161	2183	8"
SMC8 60/14E	60177284	63	85	334	297	290	280	269	259	246	231	212	190	165	141	116	5"	172	2319	8"
SMC8 60/15F	60177285	63	85	349	313	308	298	286	275	260	243	222	198	172	147	122	5"	182	2455	8"
SMC8 60/15C	60177286	75	100	375	340	334	324	313	300	287	270	247	222	194	164	135	5"	183	2455	8"
SMC8 60/15B	60177287	75	100	385	358	350	340	327	315	302	286	265	243	217	188	159	5"	184	2455	8"
SMC8 60/16B	60177288	75	100	411	382	374	363	349	333	316	298	278	255	228	200	170	5"	195	2591	8"
SMC8 60/18B	60177289	92	125	460	423	412	400	386	369	350	328	304	277	248	218	187	5"	216	2863	8"
SMC8 60/19B	60177290	92	125	488	453	444	431	415	396	376	354	330	303	271	238	202	5"	227	2999	8"

## SMC8

8" SUBMERSIBLE PUMPS



## SMC8 85 HYDRAULIC PART

MODEL	HYDRAULIC PART CODE	ELECTRICAL DATA		HYDRAULIC DATA														DNM	WEIGHT KG	H mm	MOTOR COUPLING
		P2 NOMINAL REQUESTED		Q=m³h	0	36	54	60	66	72	78	84	90	96	102	108	114				
		kW	HP	Q=l/min	0	600	900	1000	1100	1200	1300	1400	1500	1600	1700	1800	1900				
SMC8 85/1A	60177291	5,5	7,5	27	21,5	20	19,5	18,5	18	17,5	16,5	15,5	14,5	13	12	10,5	5"	32	551	6"	
SMC8 85/2F	60177292	7,5	10	44	34,5	30,5	29,5	28	27	25	23	21	18,5	16,5	14	12,5	5"	41	687	6"	
SMC8 85/2D	60177293	9,3	12,5	51	41	36,5	35	33,5	32,5	31,5	29,5	27	24,5	21,5	19	16	5"	42	687	6"	
SMC8 85/3F	60177294	11	15	66	52	46	44	42	40	37,5	35	31,5	27,5	24,5	21,5	18	5"	52	823	6"	
SMC8 85/3E	60177295	13	17,5	75	60,5	54,5	52,5	50	48,5	46	43,5	40	35,5	31,5	27,5	23	5"	52	823	6"	
SMC8 85/3B	60177298	15	20	78,5	63	57	55	53	51	49	46,5	42,5	38,5	34	30	25	5"	52	823	6"	
SMC8 85/4E	60177299	18,5	25	91	72	65	62,5	60	57	54	50	45,5	41	35,5	30	24,5	5"	63	959	6"	
SMC8 85/4D	60177303	18,5	25	103	81,5	73	70	67	65	62,5	59	54	49	43,5	38	32,5	5"	63	959	6"	
SMC8 85/4B	60177304	22	30	105	85,5	77	74	71	68,5	65,5	62,5	57,5	52	46,5	40,5	34,5	5"	63	959	6"	
SMC8 85/5E	60177306	22	30	124	99	89	85	81,5	78,5	74,5	69,5	63	57	50	43,5	36,5	5"	73	1095	6"	
SMC8 85/5A	60177307	26	35	136	113	102	98	94	91	87,5	83,5	77,5	70,5	63	56	48,5	5"	74	1095	6"	
SMC8 85/6E	60177308	26	35	148	119	107	102	98	94	89,5	83	76	68	60	52	43,5	5"	84	1231	6"	
SMC8 85/6B	60177309	30	40	157	128	116	111	107	103	98,5	93	85	77	68	59,5	50,5	5"	84	1231	6"	
SMC8 85/7E	60177310	30	40	173	139	125	120	116	110	104	97,5	88,5	79,5	70	61	51	5"	94	1367	6"	
SMC8 85/7D	60177311	37	50	178	145	131	126	121	116	111	105	95	85	75	65	54,5	5"	95	1367	6"	
SMC8 85/8D	60177312	37	50	202	161	145	140	134	128	122	116	105	93,5	81,5	70	57	5"	105	1503	6"	
SMC8 85/8C	60177313	45	60	212	173	157	151	146	141	135	128	118	106	94,5	83	70	5"	107	1503	8"	
SMC8 85/9C	60177314	45	60	237	194	175	169	162	157	150	142	131	117	104	91	76,5	5"	117	1639	8"	
SMC8 85/10C	60177315	55	75	267	218	196	189	182	176	170	162	150	137	122	106	90	5"	128	1775	8"	
SMC8 85/11C	60177316	55	75	291	239	215	207	199	192	184	174	160	146	130	114	97	5"	138	1911	8"	
SMC8 85/12D	60177317	63	85	304	251	227	218	209	201	193	182	167	150	132	114	95	5"	149	2047	8"	
SMC8 85/13E	60177318	63	85	329	262	236	227	217	208	198	188	170	152	133	114	93	5"	159	2183	8"	
SMC8 85/13C	60177319	75	100	336	281	257	247	237	229	219	206	190	172	153	134	114	5"	160	2183	8"	
SMC8 85/14C	60177320	75	100	359	301	276	265	255	245	234	221	203	183	163	142	120	5"	170	2319	8"	
SMC8 85/15C	60177321	75	100	385	322	294	284	273	263	251	237	218	196	174	152	129	5"	181	2455	8"	
SMC8 85/17C	60177322	92	125	436	365	333	322	310	298	285	269	246	222	197	173	146	5"	202	2727	8"	
SMC8 85/18C	60177323	92	125	462	387	353	340	328	315	301	285	261	235	209	183	154	5"	213	2863	8"	

## SMC8 110 HYDRAULIC PART

MODEL	HYDRAULIC PART CODE	ELECTRICAL DATA		HYDRAULIC DATA													DNM	WEIGHT KG	H mm	MOTOR COUPLING
		P2 NOMINAL REQUESTED		Q=m³h	0	36	66	84	96	102	108	114	120	126	138	156				
		kW	HP	Q=l/min	0	600	1100	1400	1600	1700	1800	1900	2000	2100	2300	2600				
SMC8 110/2H	60177324	13	17,5	47,5	42,5	39,5	37	35,5	34,5	33,5	32	30,5	28,5	24,5	17	5"	36	729	6"	
SMC8 110/3G	60177325	18,5	25	69,5	63	57,5	53	50,5	49	47	45	42	39,5	33	22	5"	46	886	6"	
SMC8 110/3B	60177326	22	30	76	69	64	60,5	57,5	56	54	51,5	49	46	39	27,5	5"	46	886	6"	
SMC8 110/4F	60177327	26	35	95	87,5	80,5	75,5	72	69,5	67	63,5	60	56	47,5	32,5	5"	56	1043	6"	
SMC8 110/5I	60177443	30	40	112,5	103,5	95	89	84	81,5	78	74	69,5	64,5	53,5	35,5	5"	66	1200	6"	
SMC8 110/5F	60177444	37	50	118	109,5	101,5	95,5	91	88	85	80,5	76	71	60,5	41,5	5"	66	1200	6"	
SMC8 110/6H	60177445	37	50	137,5	126	117	109,5	103,5	100	96	90,5	85	79	66	45	5"	76	1357	6"	
SMC8 110/6F	60177446	45	60	144,5	134	124,5	117,5	112	109	105,5	100,5	95	89	76	53,5	5"	76	1357	8"	
SMC8 110/6B	60177447	45	60	155,5	144	134,5	127	121	117,5	113,5	108,5	102,5	96,5	83	59,5	5"	76	1357	8"	
SMC8 110/7C	60177448	55	75	178,5	165,5	154	146	139	135	130,5	124,5	117,5	110	92,5	63,5	5"	86	1514	8"	
SMC8 110/9L	60177449	55	75	200,5	186	171,5	161,5	154	149	143	136	127,5	118,5	98,5	66	5"	106	1828	8"	
SMC8 110/9G	60177450	63	85	209	194,5	180	170	162	157	152	146	137,5	128,5	108,5	74,5	5"	106	1828	8"	
SMC8 110/9B	60177451	75	100	225,5	212	196,5	185,5	176,5	171,5	165,5	159,0	150,5	141,0	121,0	88,0	5"	106	1828	8"	
SMC8 110/10B	60177452	75	100	251,0	235,5	218	206	196	190,5	184	177	167,5	157	134,5	97,5	5"	116	1985	8"	
SMC8 110/11B	60177453	92	125	276	259	240	226,5	215,5	209,5	202,5	194,5	184	172,5	147,5	107,5	5"	126	2142	8"	
SMC8 110/13E	60177454	92	125	313	294	272	257	244,5	238	230	221	209	196,5	167,5	117,5	5"	146	2456	8"	
SMC8 110/14C	60177455	110	150	351	329,5	305,5	288,5	274,5	266,5	257,5	247,5	234	219,5	188	137	5"	156	2613	8"	
SMC8 110/15C	60177456	110	150	376	353	327,5	309	294	285,5	276	265,5	251	235,5	201,5	146,5	5"	166	2770	8"	

# SMC8

8" SUBMERSIBLE PUMPS



## SMC8 135 HYDRAULIC PART

MODEL	HYDRAULIC PART CODE	ELECTRICAL DATA		HYDRAULIC DATA													DNM	WEIGHT KG	H mm	MOTOR COUPLING
		P2 NOMINAL REQUESTED		Q=m³h	0	36	72	96	108	120	132	144	156	168	180	192				
		KW	HP	Q=l/min	0	600	1200	1600	1800	2000	2200	2400	2600	2800	3000	3200				
SMC8 135/2M	60177457	13	17,5	H (m)	47,5	42	37,5	34,5	33	30,5	28	24,5	20,5	16	12	8,5	5"	43	729	6"
SMC8 135/2F	60177458	15	20		52	46	41	38,5	36,5	34,5	32	29	25	21	16,5	12	5"	43	729	6"
SMC8 135/2C	60177459	18,5	25		55	48,5	43,5	41	39	37	34,5	31	27	23	19	15,5	5"	43	729	6"
SMC8 135/3N	60177460	18,5	25		63,5	58,5	53,5	49	45,5	42	37	32	26	20	14		5"	55	886	6"
SMC8 135/3L	60177461	22	30		70	64	57,5	53	50,5	47	42,5	37,5	31,5	25	19	13,5	5"	55	886	6"
SMC8 135/3B	60177462	26	35		82,5	75	68,5	64	61	58	54,5	49,5	43	36	29,5	22	5"	55	886	6"
SMC8 135/4E	60177463	30	40		101	90	82	76,5	72,5	68,5	63	56,5	49,5	41,5	33	24	5"	67	1043	6"
SMC8 135/4C	60177464	37	50		106	95	88	82	78	73,5	68	61,5	54	45,5	36,5	26,5	5"	67	1043	6"
SMC8 135/5F	60177465	37	50		121,5	111	101,5	94	89	84	77,5	69	60	50	39,5	28	5"	79	1200	6"
SMC8 135/5E	60177466	45	60		128,5	118	108	100	95,5	90,5	84,5	77	68	58,5	47,5	35,5	5"	81	1200	8"
SMC8 135/6F	60177467	45	60		151	135,5	125	116	110,5	104	96,5	86,5	76	64	51,5	38	5"	93	1357	8"
SMC8 135/7G	60177468	55	75		176	159,5	147	137	130,5	123	114	102	89	75	60	44,5	5"	105	1514	8"
SMC8 135/7E	60177469	55	75		181	164	151,5	141,5	135,5	128	119	107	94	80	65	49,5	5"	105	1514	8"
SMC8 135/8G	60177470	63	85		201,5	182	168	156,5	149,5	140,5	130	117	102	85,5	68,5	51	5"	117	1671	8"
SMC8 135/9G	60177471	75	100		220	200,5	185	171,5	163	153,5	141,5	127	110,5	93	74	54	5"	129	1828	8"
SMC8 135/9C	60177472	75	100		238	219,5	201,5	187	178,5	169	158	143,5	128	110,5	91	69,5	5"	129	1828	8"
SMC8 135/11C	60177473	92	125		291	268,5	246,5	228,5	218	206,5	193	175,5	156,5	135	111	85	5"	154	2142	8"
SMC8 135/13C	60177474	110	150		343,5	317	291	270	258	244	228	207,5	185	159,5	131,5	100,5	5"	178	2456	8"

COMMAND AND CONTROL SYSTEMS

CIRCULATORS AND IN-LINE PUMPS

MULTISTAGE CENTRIFUGAL AND SELF-PRIMING PUMPS

SWIMMING POOL, POND AND SALT WATER PUMPS

CENTRIFUGAL PUMPS

SUBMERSIBLE PUMPS

SUBMERSIBLE PUMPS AND SUBMERSIBLE MOTORS

PRESSURE UNITS

# SMC10

10" SUBMERSIBLE PUMPS



Multistage semiaxial submersible electric pumps for wells measuring 10" or above, able to generate a broad range of flow rates and heads. They are used extensively for the lifting, distribution and pressurisation of industrial water systems, the supply of booster pumps and tanks, firefighting systems and irrigation systems. Application with clean, non-aggressive water free from solids or abrasive substances.

### Construction features of the pump

Cast iron pump body treated with cataphoresis paint coating and dynamically balanced impellers in microcast AISI 304 stainless steel coupled on the shaft with pull tab. Shaft guided with coaxial bush bearings and fully protected with bushes.

Pump with check valve of low pressure loss. Flanged delivery port and kit containing counter flange, bolts and gaskets.

Refer to the technical data sheets of the specific model for the electrical characteristics of the submersible motors and the specifications for operation with inverter.

The SMN version completely in AISI 316 stainless steel is available on request.



### Operating range

up to 400 m<sup>3</sup>/h with head up to 453 m.

**Pumped liquid** clean, free of solids and abrasives, chemically neutral, with properties similar to water.

**Start-ups/hour** see the coupled motor

**Cooling flow** see the coupled motor

**Maximum permitted amount of sand** 40 g/m<sup>3</sup>

**Ambient temperature** 30 °C

**Minimum recommended level on suction line** 2 m

**Installation** horizontal or vertical

Coupling with motors of 6", 8" or 10" depending on the required hydraulic power, and available in standard version or a version completely in stainless steel.

**6GF:** encapsulated 6" submersible motor.

**TR6:** rewindable 6" submersible motor.

**TR8:** rewindable 8" submersible motor.

**TR10:** rewindable 10" submersible motor.

ACCESSORIES  
PAG. 319

## SMC10 200 HYDRAULIC PART

MODEL	HYDRAULIC PART CODE	ELECTRICAL DATA		HYDRAULIC DATA													DNM	WEIGHT KG	H mm	MOTOR COUPLING
		P2 NOMINAL REQUESTED		Q=m <sup>3</sup> /h																
		kW	HP	Q=l/min	0	60	84	108	132	150	168	180	192	210	234	258				
SMC10 200/1M	60177475	11	15	32	25,5	24	22	20,5	19	17,5	16,5	15	12,5	9		6"	66	687	6"	
SMC10 200/1L	60177476	13	17,5	35,5	29	27	25,5	24	22,5	21	19,5	18	15,5	11,5	6,5	6"	66	687	6"	
SMC10 200/1H	60177477	15	20	40	33	30,5	29	27	25,5	24	23	21,5	19	16	12	6"	66	687	6"	
SMC10 200/1G	60177478	18,5	25	41	34	32	30	28	26,5	25	24	22,5	20	17	13	6"	66	687	6"	
SMC10 200/1C	60177479	18,5	25	45	37	34,5	32,5	30,5	29	27,5	26	24,5	22	18,5	14	6"	66	687	6"	
SMC10 200/1A	60177480	22	30	48	39	36,5	34,5	32,5	31,5	29,5	28,5	27	24	19,5	14	6"	66	687	6"	
SMC10 200/2M	60177481	22	30	64	51,5	48	44,5	41	38,5	35,5	33	30	25,5	17,5		6"	92	847	6"	
SMC10 200/2L	60177482	26	35	70,5	58,5	55	52	48,5	46	43	40,5	37,5	32,5	24	14,5	6"	92	847	6"	
SMC10 200/2H	60177483	30	40	79,5	66	62	58,5	55	52	48,5	46	43	38	30	20,5	6"	92	847	6"	
SMC10 200/2G	60177484	37	50	84	70,5	66,5	62,5	59	56	52,5	50	47	41,5	34	25	6"	92	867	6"	
SMC10 200/2E	60177485	37	50	90	77	72	68	64	61	58	56	53	48	40,5	31	6"	92	867	6"	
SMC10 200/2B	60177486	45	60	94,5	80	75,5	71,5	67,5	64,5	61	59	55,5	50,5	43	34,5	6"	92	867	8"	
SMC10 200/3H	60177487	45	60	117	99	93,5	89	84	80	75,5	72	67,5	59,5	47,5	33	6"	118	1047	8"	
SMC10 200/3G	60177488	55	75	130	110	104	98,5	93	88,5	84	80	75,5	67,5	56	42	6"	118	1047	8"	
SMC10 200/3E	60177489	55	75	137	116,5	110	104,5	99	94,5	90	86,5	81,5	73,5	62,5	48,5	6"	118	1047	8"	
SMC10 200/3B	60177490	63	85	143	122	115,5	109,5	104	99,5	94,5	91,5	86,5	78,5	67,5	54	6"	118	1047	8"	
SMC10 200/4G	60177491	75	100	168,5	142,5	134,5	128	121	115	108,5	104	97,5	86,5	70,5	51	6"	162	1227	8"	
SMC10 200/4D	60177492	75	100	183,5	156	148	141	133,5	128	121,5	117	110,5	100	84	65,5	6"	162	1227	8"	
SMC10 200/5I	60177493	75	100	200	169	159,5	151,5	142,5	135,5	127,5	121,5	113,5	100,5	80	56,5	6"	187	1407	8"	
SMC10 200/5F	60177494	92	125	224	192	180,5	171,5	163	157	150	144,5	137	124	104	80	6"	187	1583	8"	
SMC10 200/6I	60177495	92	125	241	204,5	193,5	184,5	174,5	166,5	156,5	149,5	140	124	99	69	6"	213	1755	8"	
SMC10 200/6F	60177496	110	150	269	230	216,5	205,5	195,5	188,5	180	173	164	149	124,5	96	6"	213	1671	8"	
SMC10 200/7H	60177497	110	150	283	241,5	227,5	216,5	205,5	197	186,5	178,5	167	147,5	118	83	6"	239	1851	8"	
SMC10 200/7E	60177498	132	180	319	271	256,5	244	231,5	222	211	203	192,5	174	148	116,5	6"	239	1851	10"	
SMC10 200/8D	60177499	147	200	366,5	314	295,5	281	267	256,5	245	236,5	224,5	203,5	172,5	135,5	6"	264	2031	10"	
SMC10 200/9D	60177500	170	230	412	353,5	332,5	316	300,5	288,5	275,5	266	252,5	229	194	152,5	6"	290	2211	10"	
SMC10 200/10E	60177501	190	260	453	388	365	347	330	317	302	291,5	276,5	250	211	165	6"	316	2391	10"	





# SMC10

10" SUBMERSIBLE PUMPS



## SMC10 320 HYDRAULIC PART

MODEL	HYDRAULIC PART CODE	ELECTRICAL DATA		HYDRAULIC DATA													DNM	WEIGHT KG	H mm	MOTOR COUPLING	
		P2 NOMINAL REQUESTED		Q=m³h	0	120	150	180	210	240	270	300	330	360	390	420					
		kW	HP	Q=l/min	0	2000	2500	3000	3500	4000	4500	5000	5500	6000	6500	7000					
SMC10 320/10	60177502	22	30	H (mt)	34	27,5	26,5	25,5	24,5	23,5	22	20	16,5	12,5			6"	64,5	703	6"	
SMC10 320/1M	60177503	26	35		36	29,5	28,5	27,5	27	26	25	22,5	19,5	16	12,5			6"	64,5	703	6"
SMC10 320/1F	60177504	30	40		40	32,5	31	30	29,5	28,5	27,5	26	23	19,5	15,5	10,5		6"	64,5	703	6"
SMC10 320/1D	60177505	37	50		43,5	34,5	33	32	31,5	31	30,5	29	26	22,5	18,5	14		6"	64,5	703	6"
SMC10 320/1B	60177506	37	50		46	37	35	34,5	33,5	33	32,5	31	28,5	25	21	16,5		6"	65,5	703	6"
SMC10 320/2P	60177507	45	60		62	52	50,5	49	47	44	40,5	35,5	29	22				6"	91	898	8"
SMC10 320/2N	60177508	45	60		67,5	57,5	55,5	53,5	51,5	49	45,5	41,5	36	29,5	22,5	14		6"	91	898	8"
SMC10 320/2M	60177509	55	75		71	61	59	57,5	55,5	53,5	50,5	46,5	41	34	27	19,5		6"	91	898	8"
SMC10 320/2H	60177510	55	75		72	64	61,5	60	58,5	56,5	54	50,5	45,5	38,5	31	21		6"	91	898	8"
SMC10 320/2D	60177511	63	85		77	67	65	63,5	62	60,5	58	54,5	49,5	43	35,5	27		6"	91	898	8"
SMC10 320/3I	60177512	75	100		106	93,5	90,5	88	85,5	82	77,5	71,5	63	53,5	42,5	31,5		6"	116	1177	8"
SMC10 320/3C	60177513	92	125		117,5	104,5	102	99	96	94	91	86	79,5	70	57	41		6"	116	1177	8"
SMC10 320/4G	60177514	110	150		150	134,5	130	126,5	123	119	113,5	106,5	96,5	84,5	71	56		6"	160	1372	8"
SMC10 320/4B	60177515	132	180		162	147	142,5	138,5	135	130,5	125,5	118,5	108,5	96,5	84,5	69,5		6"	160	1372	10"
SMC10 320/5L	60177516	132	180		181	162	157	152,5	148	142,5	136	127	114,5	99	81,5	63		6"	185,5	1568	10"
SMC10 320/5E	60177517	150	200		196	177,5	172	167	162,5	157	150,5	141,5	129	114,5	98	79,5		6"	185,5	1568	10"
SMC10 320/6G	60177518	170	230		225	201,5	195,5	190	184,5	178	170	160	145	127	106	83,5		6"	211	1763	10"
SMC10 320/7L	60177519	190	260		253,5	227	219,5	213,5	207	199,5	190	178	160	138,5	114,5	88,5		6"	236,5	1959	10"

COMMAND AND CONTROL SYSTEMS

CIRCULATORS AND IN-LINE PUMPS

MULTISTAGE CENTRIFUGAL AND SELF-PRIMING PUMPS

SWIMMING POOL, POND AND SALT WATER PUMPS

CENTRIFUGAL PUMPS

SUBMERSIBLE PUMPS

SUBMERSIBLE PUMPS AND SUBMERSIBLE MOTORS

PRESSURE UNITS

# SMC12

12" SUBMERSIBLE PUMPS



Multistage semiaxial submersible electric pumps for wells measuring 12" or above, able to generate a broad range of flow rates and heads. They are used extensively for the lifting, distribution and pressurisation of industrial water systems, the supply of booster pumps and tanks, firefighting systems and irrigation systems. Application with clean, non-aggressive water free from solids or abrasive substances.

### Construction features of the pump

Cast iron pump body treated with cathodolysis paint coating and dynamically balanced impellers in microcast AISI 304 stainless steel coupled on the shaft with pull tab. Shaft guided with coaxial bush bearings and fully protected with bushes.

Pump with check valve of low pressure loss. Flanged delivery port and kit containing counter flange, bolts and gaskets.

Refer to the technical data sheets of the specific model for the electrical characteristics of the submersible motors and the specifications for operation with inverter.

The SMN version completely in AISI 316 stainless steel is available on request.

### Operating range

up to 540 m<sup>3</sup>/h with head up to 320 m.

**Pumped liquid** clean, free of solids and abrasives, chemically neutral, with properties similar to water.

**Start-ups/hour** see the coupled motor

**Cooling flow** see the coupled motor

**Maximum permitted amount of sand** 40 g/m<sup>3</sup>

**Ambient temperature** 30 °C

**Minimum recommended level on suction line** 2.5 m

**Installation** horizontal or vertical

Coupling with motors of 8", 10" or 12" depending on the required hydraulic power, and available in standard version or a version completely in stainless steel.

**TR8:** rewindable 8" submersible motor.

**TR10:** rewindable 10" submersible motor.

**TR12:** rewindable 12" submersible motor.

ACCESSORIES  
PAG. 319

## SMC12 360 HYDRAULIC PART

MODEL	HYDRAULIC PART CODE	ELECTRICAL DATA		HYDRAULIC DATA														DNM	WEIGHT KG	H mm	MOTOR COUPLING
		P2 NOMINAL REQUESTED		Q=m <sup>3</sup> /h	0	180	210	240	270	285	300	315	330	360	390	420	450				
		kW	HP	Q=l/min	0	3000	3500	4000	4500	4750	5000	5250	5500	6000	6500	7000	7500				
SMC12 360/1A	60177520	45	60	H (mt)	55,5	46	44,5	43	41,5	40,5	39,5	38	36,5	33,5	29,5	25	20	7"	136	899	8"
SMC12 360/1B	60177521	55	75		63	51	49,5	48	46,5	46	45	44	42,5	39	35,5	31	26	7"	136	899	8"
SMC12 360/1C	60177522	75	100		65,5	54,5	53,5	52	50,5	49,5	49	48	46,5	44	40,5	37	33	7"	136	899	8"
SMC12 360/2A	60177523	75	100		100,5	85	82,5	79	75	72,5	69,5	66,5	62,5	53,5	43,5	33		7"	174	1099	8"
SMC12 360/2B	60177524	92	125		117,5	97,5	95	92	88,5	86,5	84	81	77,5	68,5	58,5	47		7"	174	1099	8"
SMC12 360/2C	60177525	110	150		130,5	107,5	105	102,5	99,5	98	96,5	94,5	91,5	85,5	77,5	68,5	57,5	7"	178	1124	8"
SMC12 360/3A	60177526	132	180		168,5	139	134	129,5	125	122	119,5	116,5	112	101,5	86,5	65		7"	217	1324	10"
SMC12 360/3B	60177527	147	200		185	153,5	149	144	139,5	137	134	131	127	117,5	104,5	87	61,5	7"	217	1324	10"
SMC12 360/4A	60177528	190	260		224,5	193	188	182,5	176	171,5	167	162	155,5	140	122,5	102		7"	255	1524	10"
SMC12 360/5A	60177529	220	300		295,5	237,5	230	221,5	213,5	207,5	201,5	193	183,5	163,5	138	105		7"	294	1724	12"
SMC12 360/5B	60177530	250	340	319,5	259	252	244,5	236	231	224,5	217,5	208	187,5	166,5	137,5	100	7"	294	1724	12"	

## SMC12 420 HYDRAULIC PART

MODEL	HYDRAULIC PART CODE	ELECTRICAL DATA		HYDRAULIC DATA														DNM	WEIGHT KG	H mm	MOTOR COUPLING
		P2 NOMINAL REQUESTED		Q=m <sup>3</sup> /h	0	210	240	270	300	330	360	390	420	450	480	510	540				
		kW	HP	Q=l/min	0	3500	4000	4500	5000	5500	6000	6500	7000	7500	8000	8500	9000				
SMC12 420/1A	60177531	45	60	H (mt)	52	39,5	38	36,5	35	34	32,5	30,5	28,5	26	22,5	19	14	7"	134	899	8"
SMC12 420/1B	60177532	55	75		58,5	44,5	43	41,5	40	39	38	36,5	35	32,5	30	26,5	22	7"	134	899	8"
SMC12 420/2A	60177533	92	125		101,5	80,5	78	75,5	73	70,5	67,5	64,5	60,5	56	51,5	46	40,5	7"	170	1099	8"
SMC12 420/2B	60177534	110	150		114,5	90,5	88	85,5	83	80,5	77,5	74,5	71	66	61	54	46	7"	174	1124	8"
SMC12 420/3A	60177535	132	180		134	111	107,5	104	100,5	96,5	92,5	88	82	75,5	68	59,5	50,5	7"	211	1324	10"
SMC12 420/3B	60177536	147	200		156,5	124	120,5	117	114	110	106,5	102,5	97	90,5	83,5	75,5	66,5	7"	211	1324	10"
SMC12 420/4A	60177537	190	260		196	154	149,5	145	140,5	135,5	130	124	116,5	107,5	97	85,5	72	7"	247	1524	10"
SMC12 420/4B	60177538	220	300		221	173,5	169	165	161	156,5	152	147	139,5	131	121,5	110,5	96	7"	247	1524	12"
SMC12 420/5A	60177539	250	340		260,5	204	198	192,5	187	182	176,5	170,5	162	152	139	121,5	100	7"	284	1724	12"

# 6GF / 6GX

6" SUBMERSIBLE MOTORS



6-inch submersible motors designed for pressure boosting, gardening and irrigation, drawing water from subsoil in civil and commercial applications and for using water in irrigation systems also in agriculture.

#### 6GX model:

- made of AISI 316 stainless steel.
- with SiC/SiC mechanical seal.

#### 6GF model:

- made of AISI 304 and cast iron protected with an electrophoretic paint coating for the part submerged in water. Encapsulated and resin-filled stator. Cooled and lubricated with a mixture of water and glycol. Combined with the pump body, it is able to draw water from wells of at least 6" (or tanks and cisterns). Single-phase versions to be combined with an external panel that integrates the capacitor and the manually resettable overload protection. Different versions are available with the addition, during installation, of the PT100 or PTC temperature sensor which can also come with star-delta start-up.

Flanging NEMA 6".

Insulation class F.

Protection class IP68.

Cooling flow speed min. 0,3 m/s 35 °C.

Power supply tolerance + 6 % / -10 %.

Max. starts 25/h.

Max operating depth 300 m.

Horizontal operation 5,5 HP - 50 HP.

On request cables of a different length, different power input voltages, single-phase version (up to 15 HP).



## 6GF / 6GX DIRECT STARTING

MODEL	STANDARD	MODEL	AISI 316
	CODE		CODE
6GF - 4 KW	0605500	6GX - 4 KW	60141626
6GF - 5,5 KW	0607500	6GX - 5,5 KW	60141627
6GF - 7,5 KW	0610000	6GX - 7,5 KW	60121376
6GF - 9,2 KW	0612500	6GX - 9,2 KW	60141628
6GF - 11 KW	0615000	6GX - 11 KW	60131136
6GF - 13 KW	60179200	6GX - 13 KW	60180702
6GF - 15 KW	0620000	6GX - 15 KW	60141629
6GF - 18,5 KW	0625000	6GX - 18,5 KW	60141630
6GF - 22 KW	0630000	6GX - 22 KW	60141631
6GF - 30 KW	0640000	6GX - 30 KW	60141632
6GF - 37 KW	0650000	6GX - 37 KW	60141633
6GF - 45 KW	0660000	6GX - 45 KW	60174647

Cable included

P2 (HP)	P2 (KW)	VOLTAGE 50 Hz	IN (A)	Is/In	P1 (W)	N (min <sup>-1</sup> )	Cos φ	η %	CABLE	
									Ø (mm <sup>2</sup> )	LC (m)
5,5	4	3 x 400 V~	10,6	4,1	5290	2845	0,75	76	4x4	4
7,5	5,5	3 x 400 V~	14	4,6	7270	2845	0,75	76	4x4	4
10	7,5	3 x 400 V~	18	4,1	9550	2840	0,78	78	4x4	4
12,5	9,2	3 x 400 V~	22	3,9	11460	2840	0,8	80	4x4	4
15	11	3 x 400 V~	25,5	4,4	13860	2840	0,82	79	4x4	4
17,5	13	3 x 400 V~	29	4,6	16100	2840	0,8	81	4x4	4
20	15	3 x 400 V~	33,4	4,8	17960	2840	0,8	83	4x4	4
25	18,5	3 x 400 V~	41	5,2	22300	2845	0,8	83	4x4	4
30	22	3 x 400 V~	47	5,1	26500	2825	0,84	83	4x4	4
40	30	3 x 400 V~	61,5	4,6	35130	2830	0,85	85	4x8	4
50	37	3 x 400 V~	79,3	3,7	44200	2830	0,84	82	4x8	4
60	45	3 x 400 V~	95	5,5	55000	2840	0,83	82	4x8	4

Available on request Voltage 3 x 230 V version up to 22 kW.

## 6GF / 6GX STAR/DELTA STARTING

MODEL	STANDARD	MODEL	AISI 316
	CODE		CODE
6GF - 4 KW	0605620	6GX - 4 KW	60141634
6GF - 5,5 KW	0607510	6GX - 5,5 KW	60141635
6GF - 7,5 KW	0611750	6GX - 7,5 KW	60141636
6GF - 9,2 KW	0614000	6GX - 9,2 KW	60141637
6GF - 11 KW	0617500	6GX - 11 KW	60141638
6GF - 13 KW	60180703	6GX - 13 KW	60180704
6GF - 15 KW	0622500	6GX - 15 KW	60141639
6GF - 18,5 KW	0627500	6GX - 18,5 KW	60141640
6GF - 22 KW	0632400	6GX - 22 KW	60133153
6GF - 30 KW	0642500	6GX - 30 KW	60141641
6GF - 37 KW	0650005	6GX - 37 KW	60141642
6GF - 45 KW	60174646	6GX - 45 KW	60174648

2 cables included

P2 (HP)	P2 (KW)	VOLTAGE 50 Hz	IN (A)	Is/In	P1 (W)	N (min <sup>-1</sup> )	Cos φ	η %	CABLE	
									Ø (mm <sup>2</sup> )	LC (m)
5,5	4	3 x 400 V~	10,6	4,1	5290	2845	0,75	76	4x4	4
7,5	5,5	3 x 400 V~	14	4,6	7270	2845	0,75	76	4x4	4
10	7,5	3 x 400 V~	18	4,1	9550	2840	0,78	78	4x4	4
12,5	9,2	3 x 400 V~	22	3,9	11460	2840	0,8	80	4x4	4
15	11	3 x 400 V~	25,5	4,4	13860	2840	0,82	79	4x4	4
17,5	13	3 x 400 V~	29	4,6	16100	2840	0,8	81	4x4	4
20	15	3 x 400 V~	33,4	4,8	17960	2840	0,8	83	4x4	4
25	18,5	3 x 400 V~	41	5,2	22300	2845	0,8	83	4x4	4
30	22	3 x 400 V~	47	5,1	26500	2825	0,84	83	4x4	4
40	30	3 x 400 V~	61,5	4,6	35130	2830	0,85	85	4x8	4
50	37	3 x 400 V~	79,3	3,7	44200	2830	0,84	82	4x8	4
60	45	3 x 400 V~	95	5,5	55000	2840	0,83	82	4x8	4

Available on request Voltage 3 x 230 V version up to 22 kW.

# TR6

6" SUBMERSIBLE MOTORS



6" Asynchronous two-poles submersible motor, **rewindable type**, made in AISI 304 stainless steel and cast iron with paint coating (standard version). Cooling and lubrication of the thrust bearing assembly and carbon bushes is provided by a mixture of water and glycol. Squirrel-cage rotor mounted on Mitchell self-centring thrust bearing. The motor is available also in full stainless steel AISI 316 version and on demand AISI 904 version. Mechanical seal in ceramic/ carbon for the standard version, in silicon/carbide for the AISI 316 stainless steel version. On request it's available also a version suitable for use with variable frequency drive (30 Hz –60 Hz). The motor is equipped with 5 meters one-core round cable three-core flat cable directly connected with the windings and a ground cable, and it's available with DOL or STAR-DELTA starting type. The cable is certified ACS and WRAS. Overload protection must be provided by user. On request PT100 and PTC temperature sensors are available.

Standard version with PVC windings.

**AVAILABLE ON REQUEST A PE2 + PA WINDING VERSION FOR INVERTER APPLICATION.**

**Flanging** NEMA 6".

**Protection class** IP68.

**Cooling flow speed** 0,5 m/s.

**Power supply tolerance** + 6 % / -10 %.

**Max. starts** 15/h.

**Max operating depth** 300 m.

**Maximum operating pressure** 60 bar.

**Horizontal operation** 7,5 HP - 50 HP.



## DIRECT STARTING

MODEL	STANDARD		AISI 316		P2 (HP)	P2 (kW)	VOLTAGE 50 Hz	IN (A)	ls/in	N (min <sup>-1</sup> )	CABLE	
	PVC	PE2 + PA	PVC	PE2 + PA							Ø mm <sup>2</sup>	LC (m)
	CODE	CODE	CODE	CODE								
TR607 - 5,5 KW	60144263	60146662	60146624	60146684	7,5	5,5	3x400 V~	13,7	3,5	2870	4x6	5
TR610 - 7,5 KW	60144264	60146663	60146625	60146685	10	7,5	3x400 V~	18,2	3,6	2860	4x6	5
TR612 - 9,2 KW	60144265	60146664	60146626	60146686	12,5	9,2	3x400 V~	21,7	3,5	2850	4x6	5
TR615 - 11 KW	60144266	60146665	60146627	60146687	15	11	3x400 V~	26,2	3,7	2860	4x6	5
TR617 - 13KW	60144267	60146667	60146628	60146688	17,5	13	3x400 V~	30,5	3,8	2850	4x6	5
TR620 - 15 KW	60144268	60146668	60146629	60146689	20	15	3x400 V~	34,8	4,2	2860	4x6	5
TR625 - 18,5 KW	60144269	60146669	60146630	60146690	25	18,5	3x400 V~	41,4	4,5	2860	4x6	5
TR630 - 22 KW	60144270	60146670	60146631	60146691	30	22	3x400 V~	49,0	5,5	2880	4x6	5
TR635 - 26 KW	60144271	60146671	60146632	60146692	35	26	3x400 V~	58,1	5,7	2880	4x6	5
TR640 - 30 KW	60144272	60146672	60146633	60146693	40	30	3x400 V~	64,9	5,0	2870	4x10	5
TR650 - 37 KW	60144273	60146673	60146634	60146694	50	37	3x400 V~	80,5	5,1	2860	4x10	5
TR660 - 45 KW	-	60161601	-	60164305	60	45	3x400 V~	93,1	5,1	2825	4x10	5

Cable included

## STAR/DELTA STARTING

MODEL	STANDARD		AISI 316		P2 (HP)	P2 (kW)	VOLTAGE 50 Hz	IN (A)	ls/in	N (min <sup>-1</sup> )	CABLE	
	PVC	PE2 + PA	PVC	PE2 + PA							Ø mm <sup>2</sup>	LC (m)
	CODE	CODE	CODE	CODE								
TR615 - 11 KW	60144277	-	60146635	-	15	11	3x400 V~	26,2	3,7	2860	4x6	5
TR617 - 13 KW	60144278	60146676	60146636	60146696	17,5	13	3x400 V~	30,5	3,8	2850	4x6	5
TR620 - 15 KW	60144279	60146677	60146637	60146697	20	15	3x400 V~	34,8	4,2	2860	4x6	5
TR625 - 18,5 KW	60144280	60146678	60146638	60146698	25	18,5	3x400 V~	41,4	4,5	2860	4x6	5
TR630 - 22 KW	60144281	60146679	60146639	60146699	30	22	3x400 V~	49,0	5,5	2880	4x6	5
TR635 - 26 KW	60144282	60146681	60146640	60146700	35	26	3x400 V~	58,1	5,7	2880	4x6	5
TR640 - 30 KW	60144283	60146682	60146641	60146701	40	30	3x400 V~	64,9	5,0	2870	4x6	5
TR650 - 37 KW	60144284	60146683	60146642	60146702	50	37	3x400 V~	80,5	5,1	2860	4x6	5
TR660 - 45 KW	-	60164307	-	60164306	60	45	3x400 V~	93,1	5,1	2825	4x6	5

2 cables included

# TR8

8" SUBMERSIBLE MOTORS



8" Asynchronous two-poles or four-poles submersible motor, rewindable type, with external shell made in AISI 316 stainless steel and supports in cast iron with paint coating (standard version). Cooling and lubrication of the thrust bearing assembly and carbon bushes is provided by a mixture of water and glycol. Squirrel-cage rotor mounted on Mitchell self-centring thrust bearing. The motor is available also in full stainless steel AISI 316 version and on demand AISI 904 version. Mechanical seal in silicon/carbide. On request it's available also a version suitable for use with variable frequency drive.

The motor is equipped with 5 meters one-core round cable three-core flat cable directly connected with the windings and it's available with DOL or STAR-DELTA starting type. The cable is certified ACS and WRAS. Overload protection must be provided by user. On request PT100 and PTC temperature sensors.

Standard version with PVC windings.  
AVAILABLE ON REQUEST A PE2 + PA WINDING VERSION FOR INVERTER APPLICATION.

**Flanging** NEMA 8".

**Protection class** IP68.

**Cooling flow speed** 0,5 m/s.

**Power supply tolerance** + 6 % / - 10 %.

**Max. starts** 10/h.

**Max operating depth** 300 m.

**Maximum operating pressure** 60 bar.

**Horizontal operation** 30 HP - 125 HP.



## DIRECT STARTING

MODEL	STANDARD		AISI 316		P2 (HP)	P2 (kW)	VOLTAGE 50 Hz	IN (A)	ls/lm	N (min <sup>-1</sup> )	CABLE	
	PVC	PE2 + PA	PVC	PE2 + PA							Ø mm <sup>2</sup>	LC (m)
	CODE	CODE	CODE	CODE								
TR840 - 30KW	60144580	60144600	60146726	60146759	40	30	3 x 400 V ~	61	5,7	2890	4x16	5
TR850 - 37KW	60144581	60144601	60146727	60146760	50	37	3 x 400 V ~	75	5,7	2890	4x16	5
TR860 - 45KW	60144582	60144602	60146728	60146761	60	45	3 x 400 V ~	92	6,0	2910	4x16	5
TR875 - 55KW	60144583	60144603	60146729	60146762	75	55	3 x 400 V ~	109	5,9	2900	4x16	5
TR885 - 63KW	60144584	60144604	60146730	60146763	85	63	3 x 400 V ~	126	5,7	2910	4x16	5
TR8100 - 75KW	60144585	60144605	60146731	60146764	100	75	3 x 400 V ~	145	5,8	2910	4x16	5
TR8125 - 92KW	60144586	60144606	60146732	60146765	125	92	3 x 400 V ~	177	5,9	2890	4x25	5
TR8150 - 110KW	60144587	60144607	60146733	60146767	150	110	3 x 400 V ~	213	5,8	2890	4x25	5

Cable included

## STAR/DELTA STARTING

MODEL	STANDARD		AISI 316		P2 (HP)	P2 (kW)	VOLTAGE 50 Hz	IN (A)	ls/lm	N (min <sup>-1</sup> )	CABLE	
	PVC	PE2 + PA	PVC	PE2 + PA							Ø mm <sup>2</sup>	LC (m)
	CODE	CODE	CODE	CODE								
TR840 - 30KW	60144590	60144610	60146734	60146768	40	30	3 x 400 V ~	61	5,7	2890	4x10	5
TR850 - 37KW	60144591	60144611	60146735	60146769	50	37	3 x 400 V ~	75	5,7	2890	4x10	5
TR860 - 45KW	60144592	60144612	60146736	60146770	60	45	3 x 400 V ~	92	6,0	2910	4x10	5
TR875 - 55KW	60144593	60144613	60146737	60146771	75	55	3 x 400 V ~	109	5,9	2900	4x16	5
TR885 - 63KW	60144594	60144614	60146738	60146772	85	63	3 x 400 V ~	126	5,7	2910	4x16	5
TR8100 - 75KW	60144595	60144615	60146739	60146773	100	75	3 x 400 V ~	145	5,8	2910	4x16	5
TR8125 - 92KW	60144596	60144616	60146740	60146774	125	92	3 x 400 V ~	177	5,9	2890	4x16	5
TR8150 - 110KW	60144597	60144617	60146741	60146775	150	110	3 x 400 V ~	213	5,8	2890	4x16	5

2 cables included

# TR10

10" SUBMERSIBLE MOTORS



10" Asynchronous two-poles or four-poles submersible motor, **rewindable type**, with external shell made in AISI 316 stainless steel and supports in cast iron with paint coating (standard version). Cooling and lubrication of the thrust bearing assembly and carbon bushes is provided by a mixture of water and glycol. Squirrel-cage rotor mounted on Mitchell self-centring thrust bearing. The motor is available also in full stainless steel AISI 316 version and on demand AISI 904 version. Mechanical seal in silicon/carbide. On request it's available also a version suitable for use with variable frequency drive. The motor is equipped with 8 meters single-core flat cables directly connected with the windings and it's available with DOL or STAR-DELTA starting type. The cables are certified ACS and WRAS. Overload protection must be provided by user. On request PT100 and PTC temperature sensors are available.

Standard version with PVC windings (except TR10 230 and TR10 260 standard, version PE2 + PA)

**AVAILABLE ON REQUEST A PE2 + PA WINDING VERSION FOR INVERTER APPLICATION.**

**Flanging** 10".

**Protection class** IP68.

**Cooling flow speed** 0,5 m/s.

**Power supply tolerance** + 6 % / - 10 %.

**Max. starts** 8/h.

**Max operating depth** 300 m.

**Maximum operating pressure** 60 bar.

**Horizontal operation** 100 HP - 230 HP.



## DIRECT STARTING

MODEL	STANDARD		AISI 316		P2 (HP)	P2 kW	VOLTAGE 50 Hz	IN (A)	ls/ln	N (min <sup>-1</sup> )	CABLE	
	PVC	PE2 + PA	PVC	PE2 + PA							Ø mm <sup>2</sup>	LC (m)
	CODE	CODE	CODE	CODE								
TR10100 - 75KW	60146792	60146838	60146818	60146852	100	75	3 x 400 V ~	148	5,4	2910	4x50	8
TR10125 - 92KW	60146793	60146839	60146819	60146853	125	92	3 x 400 V ~	185	5,6	2910	4x50	8
TR10150 - 110KW	60146794	60146840	60146820	60146854	150	110	3 x 400 V ~	217	5,7	2910	4x50	8
TR10180 - 132KW	60146795	60146841	60146821	60146855	180	132	3 x 400 V ~	257	5,7	2910	4x50	8
TR10200 - 147KW	60146796	60146842	60146822	60146856	200	147	3 x 400 V ~	300	6,2	2920	4x50	8
TR10230 - 170KW	-	60146843	-	60146857	230	170	3 x 400 V ~	348	6,0	2920	4x50	8
TR10260 - 190KW	-	60146844	-	60146858	260	190	3 x 400 V ~	405	5,9	2930	4x50	8

Cable included

## STAR/DELTA STARTING

MODEL	STANDARD		AISI 316		P2 (HP)	P2 kW	VOLTAGE 50 Hz	IN (A)	ls/ln	N (min <sup>-1</sup> )	CABLE	
	PVC	PE2 + PA	PVC	PE2 + PA							Ø mm <sup>2</sup>	LC (m)
	CODE	CODE	CODE	CODE								
TR10100 - 75KW	60146797	60146845	60146823	60146859	100	75	3 x 400 V ~	148	5,4	2910	4x35	8
TR10125 - 92KW	60146798	60146846	60146824	60146860	125	92	3 x 400 V ~	185	5,6	2910	4x35	8
TR10150 - 110KW	60146815	60146847	60146825	60146861	150	110	3 x 400 V ~	217	5,7	2910	4x35	8
TR10180 - 132KW	60146816	60146848	60146826	60146862	180	132	3 x 400 V ~	257	5,7	2910	4x35	8
TR10200 - 147KW	60146817	60146849	60146827	60146863	200	147	3 x 400 V ~	300	6,2	2920	4x35	8
TR10230 - 170KW	-	60146850	-	60146864	230	170	3 x 400 V ~	348	6,0	2920	4x35	8
TR10260 - 190KW	-	60146851	-	60146865	260	190	3 x 400 V ~	405	5,9	2930	4x35	8

2 cables included

# TR12

12" SUBMERSIBLE MOTORS



12" Asynchronous two-poles or four-poles submersible motor, **rewindable type**, with external shell made in AISI 316 stainless steel and supports in cast iron with paint coating (standard version). Cooling and lubrication of the thrust bearing assembly and carbon bushes is provided by a mixture of water and glycol. Squirrel-cage rotor mounted on Mitchell self-centring thrust bearing. The motor is available also in full stainless steel AISI 316 version. Mechanical seal in silicon/carbide. On request it's available also a version suitable for use with variable frequency drive. The motor is equipped with 8 meters single-core flat cables directly connected with the windings and it's available with DOL or STAR-DELTA starting type. The cables are certified ACS and WRAS. Overload protection must be provided by user. On request PT100 and PTC temperature sensors are available.

Standard version with PVC windings (except TR12300 and TR12340 standard, version PE2 + PA).

**AVAILABLE ON REQUEST A PE2 + PA WINDING VERSION FOR INVERTER APPLICATION.**

**Flanging** 12".

**Protection class** IP68.

**Cooling flow speed** 0,5 m/s.

**Power supply tolerance** + 6 % / -10 %.

**Max. starts** 5/h.

**Max operating depth** 300 m.

**Maximum operating pressure** 60 bar.

**Horizontal operation** 180 HP - 260 HP.

**Direction of rotation** to be specified in the order; the standard version turns anti-clockwise.



## DIRECT STARTING

MODEL	STANDARD		AISI 316		P2 (HP)	P2 (kW)	VOLTAGE 50 Hz	IN (A)	ls/ln	N (min <sup>-1</sup> )	CABLE	
	PVC	PE2 + PA	PVC	PE2 + PA							Ø mm <sup>2</sup>	LC (m)
	CODE	CODE	CODE	CODE								
TR12180 - 132KW	60146880	60146896	60146888	60146910	180	132	3x400 V~	266	5,0	2930	4x70	8
TR12200 - 147KW	60146881	60146897	60146889	60146911	200	147	3x400 V~	290	6,2	2930	4x70	8
TR12230 - 170KW	60146882	60146898	60146890	60146912	230	170	3x400 V~	329	6,1	2920	4x70	8
TR12260 - 190KW	60146883	60146899	60146891	60146913	260	190	3x400 V~	371	6,2	2930	4x70	8
TR12300 - 220KW	-	60146900	-	60146914	300	220	3x400 V~	424	6,1	2920	4x70	8
TR12340 - 250KW	-	60146901	-	60146915	340	250	3x400 V~	481	5,9	2920	4x70	8

Cable included

## STAR/DELTA STARTING

MODEL	STANDARD		AISI 316		P2 (HP)	P2 (kW)	VOLTAGE 50 Hz	IN (A)	ls/ln	N (min <sup>-1</sup> )	CABLE	
	PVC	PE2 + PA	PVC	PE2 + PA							Ø mm <sup>2</sup>	LC (m)
	CODE	CODE	CODE	CODE								
TR12180 - 132KW	60146884	60146903	60146892	60146917	180	132	3x400 V~	266	5,0	2930	4x70	8
TR12200 - 147KW	60146885	60146904	60146893	60146918	200	147	3x400 V~	290	6,2	2930	4x70	8
TR12230 - 170KW	60146886	60146905	60146894	60146919	230	170	3x400 V~	329	6,1	2920	4x70	8
TR12260 - 190KW	60146887	60146906	60146895	60146920	260	190	3x400 V~	371	6,2	2930	4x70	8
TR12300 - 220KW	-	60146907	-	60146921	300	220	3x400 V~	424	6,1	2920	4x70	8
TR12340 - 250KW	-	60146908	-	60146922	340	250	3x400 V~	481	5,9	2920	4x70	8

2 cables included





# ACCESSORIES SUBMERSIBLE PUMPS SUBMERSIBLE MOTORS

---



# ACCESSORIES

SUBMERSIBLE PUMPS AND SUBMERSIBLE MOTORS

For a correct junction, use a cable with a section greater or equal to the motor cable section.  
Size properly the section of the cable that has to be spliced, accordingly to the required length of the cable.

SHIELDED CABLE	DESCRIPTION	CODE	MICRA	S4	SS+6GF	SMC+6GF
	SHIELDED CABLE, FOUR-CORE, PER METER 4 X 1,5 mm <sup>2</sup>	60149594	•	•		
	SHIELDED CABLE, FOUR-CORE, PER METER 4 X 2,5 mm <sup>2</sup>	60149595	•	•		
	SHIELDED CABLE, FOUR-CORE, PER METER 4 X 4 mm <sup>2</sup>	60149596	•	•	•	•
We recommended the use of shielded cables with INVERTER application.						

FOUR-CORE CABLE	DESCRIPTION	CODE	MICRA	S4	SS+6GF	SMC+6GF
	FOUR-CORE CABLE H07 RN-F , PER METER 4x1.5 mm <sup>2</sup>	002730041	•	•	•	
	FOUR-CORE CABLE H07 RN-F , PER METER 4x2.5 mm <sup>2</sup>	002730051	•	•	•	
	FOUR-CORE CABLE H07 RN-F , PER METER 4x4 mm <sup>2</sup>	002730061	•	•	•	•
	FOUR-CORE CABLE H07 RN-F , PER METER 4x6 mm <sup>2</sup>	002730080	•	•	•	•
	FOUR-CORE CABLE H07 RN-F , PER METER 4x10 mm <sup>2</sup>	002730085	•	•	•	•
	FOUR-CORE CABLE H07 RN-F , PER METER 4x16 mm <sup>2</sup>	002730090	•	•	•	•
	FOUR-CORE CABLE H07 RN-F , PER METER 4x25 mm <sup>2</sup>	002730096	•	•	•	•

PROBE	DESCRIPTION	CODE	MICRA	S4	SS+6GF	SMC+6GF
	<b>COMPLETE - ELECTRODE PROBE</b> Used in the protection and CONTROL SYSTEM ES. Ideal for conductible liquids with maximum temperatures of +40°C. To be connected with a 1.5 mm <sup>2</sup> cable - 550V insulation. Sensitivity: ≤ 53 kOhm.	002775000		•	•	•
	CABLE FOR ELECTRIC PROBE, PER METER 1x1.5 mm <sup>2</sup>	002730038		•	•	•
ACCESSORIES connectable only to ES panels						

JUNCTION KIT	DESCRIPTION	CODE	MICRA	S4	SS+6GF	SMC+6GF
	CABLE JUNCTION KIT (for cable 1,0 mm <sup>2</sup> )	60141658	•			
	CABLE JUNCTION KIT (for cable 1,5-2,5-4-6 mm <sup>2</sup> )	547120020		•	•	•
	CABLE JUNCTION KIT (for cable 10-16-25 mm <sup>2</sup> )	547120030		•	•	•
	CABLE CONNECTION TO THE MOTOR-DRIVEN PUMP	AAGCA		•	•	•

# ACCESSORIES

SUBMERSIBLE PUMPS AND SUBMERSIBLE MOTORS

## TABLES TO ESTABLISH POWER CABLE CROSS SECTION IN RELATION TO LENGHT

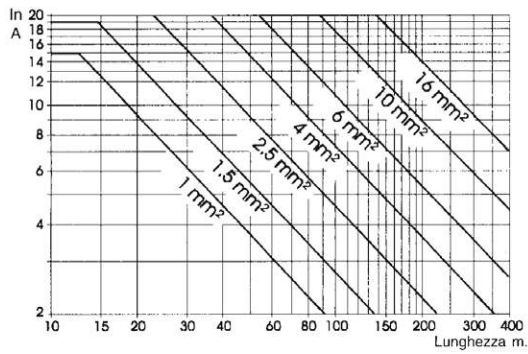

SINGLE-PHASE

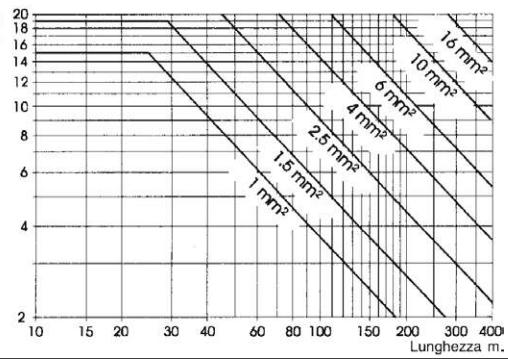

THREE-PHASE

KIT EXTENDED LEAD CABLE	DESCRIPTION	CODE
	KIT EXTENDED LEAD CABLE 4G1.5 FOR MICRA HS - 30M	60180969
	KIT EXTENDED LEAD CABLE 4G1.5 FOR MICRA HS - 60M	60180970
	KIT EXTENDED LEAD CABLE 4G1.5 FOR MICRA HS - 90M	60180971

KIT CABLE FOR MOTORS	DESCRIPTION	CODE				
			4GG	4TW	40L	6GF
	KIT CABLE 4GX1,5 MM2 -LENGHT. 20 M. WITH CONNECT. FOR 4GG/40L	60153539	•		•	
	KIT CABLE 4GX1,5 MM2 -LENGHT. 40 M. WITH CONNECT. FOR 4GG/40L	60153541	•		•	
	KIT CABLE 4GX1,5 MM2 -LENGHT. 60 M. WITH CONNECT. FOR 4GG/40L	60153543	•		•	
	KIT CABLE 4GX1,5 MM2 -LENGHT. 80 M. WITH CONNECT. FOR 4GG/40L	60153544	•		•	
	KIT CABLE 4GX1,5 MM2 -LENGHT. 100 M. WITH CONNECT. FOR 4GG/40L	60185874	•		•	
	KIT CABLE 4GX2,5 MM2 -LENGHT. 20 M. WITH CONNECT. FOR 4GG/40L	60153547	•		•	
	KIT CABLE 4GX2,5 MM2 -LENGHT. 40 M. WITH CONNECT. FOR 4GG/40L	60153614	•		•	
	KIT CABLE 4GX2,5 MM2 -LENGHT. 60 M. WITH CONNECT. FOR 4GG/40L	60185875	•		•	
	KIT CABLE 4GX2,5 MM2 -LENGHT. 80 M. WITH CONNECT. FOR 4GG/40L	60185876	•		•	
	KIT CABLE 4GX2,5 MM2 -LENGHT. 100 M. WITH CONNECT. FOR 4GG/40L	60153550	•		•	
	KIT CABLE 3GX1,5 MM2 -LENGHT. 30 M. WITH CONNECT. FOR 4"TW MOTORS	60153537		•		
	KIT CABLE 4GX4 MM2 -LENGHT. 20 M. WITH CONNECT. FOR 6GF MOTORS	60172853				•
	KIT CABLE 4GX4 MM2 -LENGHT. 40 M. WITH CONNECT. FOR 6GF MOTORS	60185877				•
	KIT CABLE 4GX4 MM2 -LENGHT. 60 M. WITH CONNECT. FOR 6GF MOTORS	60185878				•
	KIT CABLE 4GX4 MM2 -LENGHT. 80 M. WITH CONNECT. FOR 6GF MOTORS	60185879				•
	KIT CABLE 4GX4 MM2 -LENGHT. 100 M. WITH CONNECT. FOR 6GF MOTORS	60185880				•
	KIT CABLE 4GX6 MM2 -LENGHT. 20 M. WITH CONNECT. FOR 6GF MOTORS	60185881				•
	KIT CABLE 4GX6 MM2 -LENGHT. 40 M. WITH CONNECT. FOR 6GF MOTORS	60178067				•
	KIT CABLE 4GX6 MM2 -LENGHT. 60 M. WITH CONNECT. FOR 6GF MOTORS	60185882				•
	KIT CABLE 4GX6 MM2 -LENGHT. 80 M. WITH CONNECT. FOR 6GF MOTORS	60185883				•
	KIT CABLE 4GX6 MM2 -LENGHT. 100 M. WITH CONNECT. FOR 6GF MOTORS	60185884				•
	KIT CABLE 4GX10 MM2 -LENGHT. 20 M. WITH CONNECT. FOR 6GF MOTORS	60185885				•
	KIT CABLE 4GX10 MM2 -LENGHT. 40 M. WITH CONNECT. FOR 6GF MOTORS	60185886				•
KIT CABLE 4GX10 MM2 -LENGHT. 60 M. WITH CONNECT. FOR 6GF MOTORS	60185887				•	
KIT CABLE 4GX10 MM2 -LENGHT. 80 M. WITH CONNECT. FOR 6GF MOTORS	60185888				•	
KIT CABLE 4GX10 MM2 -LENGHT. 100 M. WITH CONNECT. FOR 6GF MOTORS	60185889				•	

# ACCESSORIES

## SUBMERSIBLE PUMPS AND SUBMERSIBLE MOTORS

CABLE SUBSTITUTION KIT - FE 4" ENCAPSULATED MOTOR	DESCRIPTION	CODE
	KIT CABLE SUBSTITUTION TF - 4G1.5 MT1.7 FOR 4"GG	5002315
CORROSION PROTECTION KIT FOR 4" MOTORS	DESCRIPTION	CODE
	CORROSION PROTECTION KIT - 4"GG 200/300 KG (4" WATER FILLED MOTOR)	60123038
	CORROSION PROTECTION KIT - 4"GG 600 KG (4" WATER FILLED MOTOR)	60123039
	CORROSION PROTECTION KIT - 4"OL (4" OIL FILLED MOTOR)	60151299
DIVERTRON ACCESSORIES	DESCRIPTION	CODE
	ASPIRATION KIT FOR DIVERTRON X	60187735
	AUXILIARY TANK FOR DIVERTRON	60117315
ESYBOX DIVER/DTRON ACCESSORIES	DESCRIPTION	CODE
   	<b>DCONNECT BOX 2</b> Thanks to DConnect Box 2 and the new App you can check the pump, set the starting and stopping parameters, view the details of alarms and monitor the status of the system directly on your smartphone. (Only for DTron 3 and Eskyline products, included with Eskybox Diver).	60196424
	<b>NFC WATER LEVEL MEASUREMENT</b> Only connected to the DConnect Box 2, controls the level of water in the tank and notifies the user of the level via an App. (Only for DTron 3 and Eskybox diver).	60184570
	<b>NFC FLOAT</b> Detects the level of water in a tank, preventing emptying of the latter and seizing of the pump avoiding the dry running, due to too low a level of water.	60184577
	<b>DOC68</b> The DOC68 permits installation of the DTron and Eskybox Diver even outdoors as an IP68 certified surface pump.	60192274

# ACCESSORIES

SUBMERSIBLE PUMPS AND SUBMERSIBLE MOTORS

## CB - CONTROL PANEL FOR DIVER SINGLE-PHASE PUMP

- Housing in shockproof thermoplastic with two cable clamps
- Luminous 2-pole main switch (power ON)
- Protection level: IP 43
- Starter capacitor
- Thermal cut-out protection with external manual reset

	MODEL	CODE	VOLTAGE 50 Hz	P2 NOMINAL		PROTECTION	CAPACITOR μF	DIMENSIONS mm	GROSS WEIGHT Kg	DIVER		MICRA	
				KW	HP								
	CB 16/5	60149564	1x230 V ~	0,55	0,75	5 A	16	85 x 170 x 65	0,65	•	DIVER 75 M		
	CB 20/6	60149565	1x230 V ~	0,75	1	6 A	20	85 x 170 x 65	0,65	•	DIVER 100 M DIVER 100 HF M		
	CB 30/9	60149566	1x230 V ~	1,1	1,5	9 A	30	85 x 170 x 65	0,65	•	DIVER 150 M DIVER 150 HF M		
	CB 35/12	60148895	1x230 V ~	1,5	2	12 A	35	85 x 170 x 65	0,65	•	DIVER 200 M DIVER 200 HF M		
	CBS 05/12	60140961	1 x 230V~	0,37	0,5	5 A	12	85 x 170 x 65	0,65			•	MICRA 50 M
	CBS 06/16	60140962	1 x 230V~	0,55	0,75	6 A	16	85 x 170 x 65	0,65			•	MICRA 75 M
	CBS 07/20	60140963	1 x 230V~	0,75	1	7 A	20	85 x 170 x 65	0,65			•	MICRA 100 M

## ESC PLUS

Panel for protection and control of motor/single-phase/three-phase pump with direct start up.  
 Double set-up mode: automatic/manual  
 The motor/pump protection against dry running is assured by the major of the motor cos φ, (level probes not required)  
 Casing made of shock-proof and self-extinguishing thermoplastic material with two antipull plugs.  
 Main switch.  
 Power supply:  
 Single-phase 230 V +/- 5%  
 Three-phase 400 V +/-5%  
 Three-phase 230 V on request

Digital display with status indications.  
 Four models available for powers from 0.5 HP to 15 HP.  
 Protection degree IP54. Starting  
 Capacitor for single phase version (to be order separately).  
 Optoisolated auxiliary contact for control by probes, pressure switch and float switch.  
 ON-OFF switch.  
 Functional features:  
 Overload protection.  
 Phase failure protection (threephase version).  
 Overvoltage protection.  
 Short circuit protection.  
 Protection against dry running.

	MODEL	CODE	VOLTAGE 50-60 Hz	RANGE HP	MAX CURRENT A	PANEL DIMENSIONS			WEIGHT Kg
						A	B	H	
	ESC PLUS 3M 220-240/50-60	60149590	1 x 230V<	0,5 - 3	<18	175	175	80	0,9
	ESC PLUS 4T 400/50-60	60149591	3 x 400V<	0,5 - 4	<9	245	195	95	1
	ESC PLUS 10T 400/50-60	60149592	3 x 400V<	5,5 - 10	<20	215	170	75	1,4
	ESC PLUS 15T 400/50-60	60149593	3 x 400V<	12,5 - 15	<30	215	170	75	1,6

# ACCESSORIES

SUBMERSIBLE PUMPS AND SUBMERSIBLE MOTORS

## CONTROL BOX 4"

Electric control panel for single phase bore-hole pumps featuring manually resettable overload cut-out, capacitor and terminal board for the electrical connections and possible connection of pressure switch/float. Complete with 1.5 metres of power cable with SCHUKO

EEC 7 – VII – UNEL 47166-168 electric plug. Cabinet for wall mounting in a flame-proof, thermoplastic material.

	MODEL SINGLE-PHASE	CODE	MOTOR POWER KW	PROTECTION AMPER. AMP	CAPACITOR $\mu$ F	WEIGHT Kg
	<b>CONTROL BOX 4" 0,5</b>	108003210	0,37	4	16	1,7
	<b>CONTROL BOX 4" 0,75</b>	108003220	0,55	5	20	1,7
	<b>CONTROL BOX 4" 1</b>	108003270	0,75	7	25	1,7
	<b>CONTROL BOX 4" 1,5</b>	108003280	1,1	10	35	1,7
	<b>CONTROL BOX 4" 2</b>	108003290	1,5	13	40	1,7
	<b>CONTROL BOX 4" 3</b>	108003300	2,2	16	60	1,7

## 4" CONTROL BOOSTER BOX

4" Control Booster Box

Control panel for increasing the starting torque of the single-phase electric pumps with capacities ranging from 0.37 to 3.7 kW single-phase containing the microdisgiuntore for overload protection with manual reset, the starting condenser and run condenser and terminal block for electrical connections.

Plug not included.

Degree of protection: IP 54

Ambient operating temperature: -10 °C + 40 °C

Wall mounting box in self-extinguishing thermoplastic material.

	MODEL	CODE	VOLTAGE 50 Hz	POWER MAX KW	MAX CURRENT A	RUN CAPACITOR $\mu$ F	STARTING CAPACITOR $\mu$ F	WEIGHT Kg
	<b>CBB 05/15 (0,37 KW)</b>	4616050	1 x 230 V	0,37	5	16	53-64	0,85
	<b>CBB 06/20 (0,55KW)</b>	4620060	1 x 230 V	0,55	6	20	53-64	0,85
	<b>CBB 09/25 (0,75 KW)</b>	4625090	1 x 230 V	0,75	9	25	100-130	1,5
	<b>CBB 12/35 (1,1 KW)</b>	4635120	1 x 230 V	1,1	12	35	100-130	1,1
	<b>CBB 15/40 (1,5KW)</b>	4640150	1 x 230 V	1,5	15	40	189-250	1,1
	<b>CBB 20/60 (2,2 KW)</b>	49050200	1 x 230 V	2,2	20	60	189-250	1,5
	<b>CBB 32/90 (3,7 KW)</b>	49090320	1 x 230 V	3,7	32	90	315-400	1,5

# ACCESSORIES

## SUBMERSIBLE PUMPS AND SUBMERSIBLE MOTORS

### ES 1 M - ES 3 M

Electric control unit for protecting single-phase electric borehole pumps from running without water (see table). The panel is protected and protects the electric pump from overloading and short circuits with a manually resettable device.  
Can work with 1, 2 or 3 probes depending on the use to which it is put.

Protection level: IP55.  
Temperature application range: from  $-10^{\circ}\text{C}$  to  $+40^{\circ}\text{C}$ .  
Supplied standard with an electric probe and wall bracket.  
Cabinet for wall mounting in flame-proof, thermoplastic material.

	MODEL	CODE	VOLTAGE 50/60 Hz	POWER kW p2 MOT.	MAX RATED OPERATING POWER (kW)	MAX CURRENT A	DIMENSIONS			WEIGHT Kg
							A	B	H	
	ES 1 M	108000130	1x220-240V<	0,37-0,55-0,75	1,85	10	270	300	190	5,6
	ES 3 M	108000140	1x220-240V<	1,1-1,5-2,2	2,2	16	270	300	190	5,6

### ES 0,75 T - 1 T - 1,5 T - 3 T - 4 T - 7,5 T

Electric control unit for protecting three-phase electric borehole pumps from running without water (see table). The panel is protected and protects the electric pump from overloading and short circuits with a manually resettable device.  
Can work with 1, 2 or 3 probes depending on the use to which it is put.

Protection level: IP55. Temperature application range:  
from  $-10^{\circ}\text{C}$  to  $+40^{\circ}\text{C}$ .  
Supplied standard with an electric probe and wall bracket.  
Cabinet for wall mounting in flame-proof, thermoplastic material.

	MODEL	CODE	VOLTAGE 50 Hz	POWER kW p2 MOT.	MAX RATED OPERATING POWER (kW)	MAX CURRENT A	DIMENSIONS			WEIGHT Kg
							A	B	H	
	ES 0,75 T	108000240	3 x 400V	0,37-0,55	0,88	1,6	270	300	190	5,6
	ES 1 T	108000250	3 x 400V	0,75	1,38	2,5	270	300	190	5,6
	ES 1,5 T	108000260	3 x 400V	1,1	2,2	4	270	300	190	5,6
	ES 3 T	108000270	3 x 400V	1,5 - 2,2	3,5	6,3	270	300	190	5,6
	ES 4 T	108000280	3 x 400V	3	5,5	10	270	300	190	5,6
	ES 7,5 T	108000290	3 x 400V	4-5,5	7,5	14	270	300	190	5,6

# ACCESSORIES

## SUBMERSIBLE PUMPS AND SUBMERSIBLE MOTORS

### COMMAND AND CONTROL SYSTEM - ES

Electrical panels for protection and automatic control using float/s for bore-hole three phase electric pumps, installed singularly.

Available for direct and star-delta starting.

Cabinet for wall mounting in flame-proof, thermoplastic material.

The panel is self-protected and protects the electric pump from overloading and short circuits, power failure with a manually resettable device.

Supplied complete with:

- power line switch with pad lockable door handle;
- self-protected transformer for 24V powering of external commands;

- terminals for connecting electric pump/s and min. and max. control float/s;
- Probes module for the running without water control;
- terminals for connecting a remote acoustic or luminous alarm (without potential);
- switch on the front of the panel for man - 0 - out operation of the electric pump
- Operating temperature range: -10°C +40°C
- Level of protection: IP55
- The panels are built to EN 60204-1 and EN 60439-1
- Supplied with standard electric probe.



	MODEL	CODE 3 x 380-415V~	VOLTAGE 50-60 Hz	P2 NOMINAL kW	MAX CURRENT	WEIGHT Kg
	<b>ES 7,5 T</b>	108000290	3x400V	4 - 5,5	14	5,6
	<b>ES 10 T</b>	108000600	3x400V	7,5	18	5,6
	<b>ES 12,5 T</b>	108000610	3x400V	9,2	25	5,9
	<b>ES 15 T</b>	108000620	3x400V	11	25	8
	<b>ES 20 T</b>	108000630	3x400V	15	32	8,1
	<b>ES 25 T</b>	108000640	3x400V	18,5	40	8,3
	<b>ES 30 T</b>	108000650	3x400V	22	63	8,5
	<b>ES 40 T</b>	108000660	3x400V	30	80	8,2
	<b>ES 50 T</b>	108000670	3x400V	37	90	9
	<b>ES 60 T</b>	108000680	3x400V	45	100	9
	<b>ES 75 T</b>	60168893	3x400V	55	109	-
	<b>ES 85 T</b>	60168895	3x400V	63	126	-
	<b>ES 100 T</b>	60168897	3x400V	75	148	-
	<b>ES 125 T</b>	60168899	3x400V	92	185	-
	<b>ES 150 T</b>	60168901	3x400V	110	217	-
	<b>ES 180 T</b>	60168903	3x400V	132	257	-
	<b>ES 200 T</b>	60168905	3x400V	147	300 A	-
	<b>ES 230 T</b>	60168907	3x400V	170	348 A	-
	<b>ES 260 T</b>	60168909	3x400V	190	405 A	-
	<b>ES 300 T</b>	60168911	3x400V	220	424 A	-
	<b>ES 340 T</b>	60168913	3x400V	250	481	-
	<b>ES 10 T S/D</b>	108000700	3x400V	7,5	18	5,6
	<b>ES 12,5 T S/D</b>	108000710	3x400V	9,2	25	5,9
	<b>ES 15 T S/D</b>	108000720	3x400V	11	25	8
	<b>ES 20 T S/D</b>	108000730	3x400V	15	32	8,1
	<b>ES 25 T S/D</b>	108000740	3x400V	18,5	40	8,3
	<b>ES 30 T S/D</b>	108000750	3x400V	22	63	8,5
	<b>ES 40 T S/D</b>	108000760	3x400V	30	80	8,2
	<b>ES 50 T S/D</b>	108000770	3x400V	37	90	9
	<b>ES 60 T S/D</b>	108000780	3x400V	45	100	9
	<b>ES 75 T S/D</b>	60168894	3x400V	55	109	-
	<b>ES 85 T S/D</b>	60168896	3x400V	63	126	-
	<b>ES 100 T S/D</b>	60168898	3x400V	75	148	-
	<b>ES 125 T S/D</b>	60168900	3x400V	92	185	-
	<b>ES 150 T S/D</b>	60168902	3x400V	110	217	-
	<b>ES 180 T S/D</b>	60168904	3x400V	132	257	-
	<b>ES 200 T S/D</b>	60168906	3x400V	147	300 A	-
	<b>ES 230 T S/D</b>	60168908	3x400V	170	348	-
	<b>ES 260 T S/D</b>	60168910	3x400V	190	405	-
	<b>ES 300 T S/D</b>	60168912	3x400V	220	424	-
	<b>ES 340 T S/D</b>	60168914	3x400V	250	481	-



# ACCESSORIES

SUBMERSIBLE PUMPS AND SUBMERSIBLE MOTORS

## COOLING SLEEVE FOR 4" MOTOR

### SELECTION TABLE

Cooling sleeves kit, different length, to be used to assure a perfect cooling of the 4" motors when installing the pump inside tank or where a minimum cooling flow is not granted. The sleeve choice must be done according to power and type of the motor as stated by the following table.

VOLTAGE 50 Hz	MOTOR POWER		MOTOR TYPE		
	HP	KW	4GG - 4GX	40L	4TW
Single-phase	0,5	0,37	COOLING KIT L400 cod 60125178	COOLING KIT L400 cod 60125178	COOLING KIT L525 cod 60125179
	0,75	0,55			COOLING KIT L885 cod 60125180
	1	0,75			
	1,5	1,1	COOLING KIT L525 cod 60125179	COOLING KIT L885 cod 60125180	
	2	1,5			
	3	2,2			
5	3,7	COOLING KIT L885 cod 60125180	COOLING KIT L885 cod 60125180		

Three-phase	0,5	0,37	COOLING KIT L400 cod 60125178	COOLING KIT L400 cod 60125178
	0,75	0,55		
	1	0,75		
	1,5	1,1	COOLING KIT L525 cod 60125179	COOLING KIT L525 cod 60125179
	2	1,5		
	3	2,2		
	4	3	COOLING KIT L885 cod 60125180	COOLING KIT L885 cod 60125180
	5,5	4		
	7,5	5,5		
10	7,5			

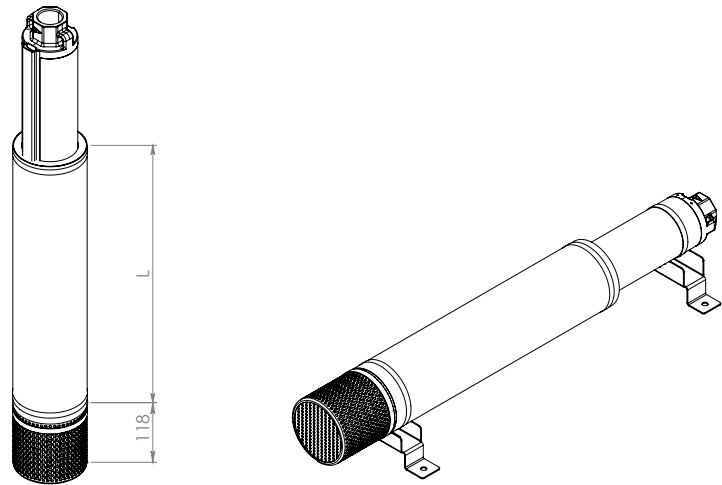
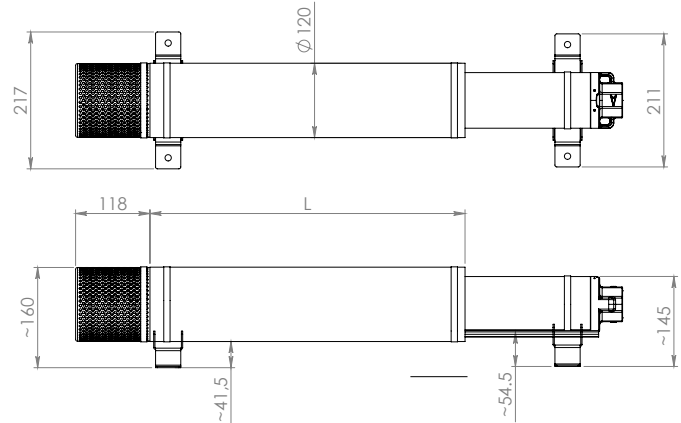

	DESCRIPTION	CODE
	COOLING SLEEVE KIT L400	60125178
	COOLING SLEEVE KIT L525	60125179
	COOLING SLEEVE KIT L885	60125180
	HORIZONTAL POSITIONING KIT (2 PIECES)	60125181
	FILTER KIT	60125182

Showed in the photo: cooling sleeve kit + horizontal positioning kit + filter kit

# ACCESSORIES

SUBMERSIBLE PUMPS AND SUBMERSIBLE MOTORS

## COOLING SLEEVE FOR 6" MOTOR

### SELECTION TABLE

Cooling sleeves kit, different length, to be used to assure a perfect cooling of the 6" motors when installing the pump inside tank or where a minimum cooling flow is not granted. The sleeve choice must be done according to power and type of the motor as stated by the following table.

NB: not suitable for 7 and 8 inches pumps.

VOLTAGE 50 Hz	MOTOR POWER		MOTOR TYPE		
	HP	KW	6GF-6GX	TR6	
Three-phase	5,5	4	COOLING KIT 725 <b>60144213</b>	COOLING KIT 960 <b>60144217</b>	
	7,5	5,5			
	10	7,5			
		12,5	9,3	COOLING KIT 960 <b>60144217</b>	COOLING KIT 1220 <b>60144218</b>
		15	11		
		17,5	13		
		20	15	COOLING KIT 1220 <b>60144218</b>	COOLING KIT 1490 <b>60146397</b>
		25	18,5		
		30	22		
		35	26	COOLING KIT 1220 <b>60144218</b>	COOLING KIT 1490 <b>60146397</b>
		40	30		
		50	37		

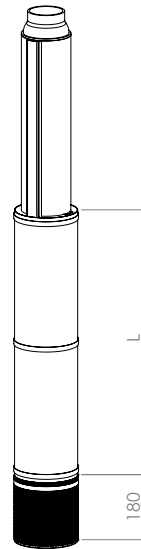
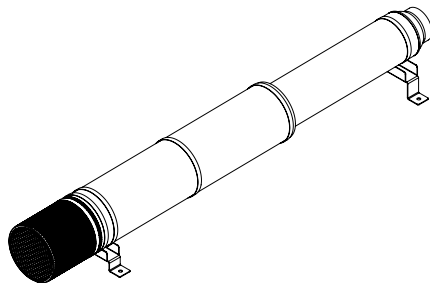
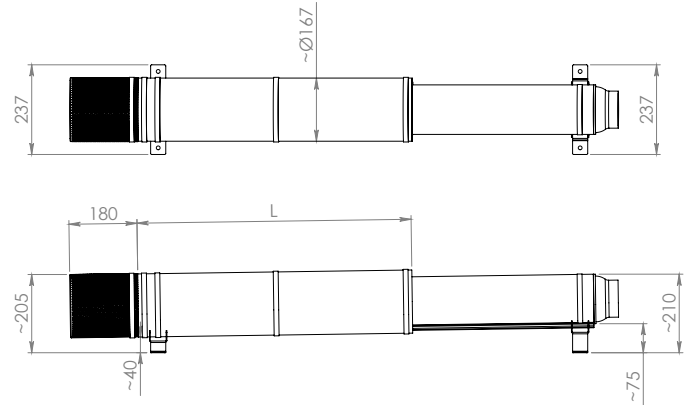

	DESCRIPTION	CODE
	COOLING SLEEVE KIT L. 725	60144213
	COOLING SLEEVE KIT L. 960	60144217
	COOLING SLEEVE KIT L. 1.220	60144218
	COOLING SLEEVE KIT L. 1.490	60146397
	HORIZONTAL POSITIONING KIT (2 PIECES)	60146398
	FILTER KIT	60146399

Shown in the photo: cooling sleeve kit + horizontal positioning kit + filter kit



PRESSURE UNITS



DOWNLOAD TECHNICAL CATALOGUE



FIRE - FIGHTING



## 2 ESYBOX WITH ESYTWIN

ELECTRONIC PRESSURIZATION SET

E7

PAG. 330



## 1/2/3 KVC AD

VARIABLE SPEED PRESSURISATION UNITS WITH ACTIVE DRIVER PLUS

BY

PAG. 331



## 2 JET AD / 2 EURO AD / 2 EUROINOX AD

VARIABLE SPEED PRESSURISATION UNITS WITH ACTIVE DRIVER PLUS

BY

PAG. 333



## 2/3 KVCXE MCE/P DCONNECT

VARIABLE SPEED BOOSTER SET WITH MCE-P VARIABLE FREQUENCY DRIVE AND DCONNECT

NEW

EJ

PAG. 334



## 1/2/3/4 NKVE 10-15-20-32-45 MCE/P

VARIABLE SPEED PRESSURISATION UNITS WITH MCE

EJ

PAG. 335



## 2/3 NKVE 10-15-20-32-45 MCE/P DCONNECT

VARIABLE SPEED BOOSTER SET WITH MCE-P VARIABLE FREQUENCY DRIVE AND DCONNECT

NEW

EJ

PAG. 339



## 2 JET

SETS WITH 2 SELF-PRIMING PUMPS

C1

PAG. 341



## 2 EURO / 2 EUROINOX

SETS WITH 2 HORIZONTAL MULTISTAGE EURO

C1

PAG. 342



## 2KI

PRESSURE SETS WITH 2 AISI 304 STAINLESS STEEL 2KI SINGLE IMPELLER CENTRIFUGAL PUMPS

C1

PAG. 343



## 2K

SETS WITH CENTRIFUGAL PUMPS TWIN IMPELLER

C1

PAG. 344



## AQUATWIN TOP

PRESSURIZATION GROUP FOR RAINWATER RECOVERY SYSTEM

C1

PAG. 345



## 1/2/3 KVC

SETS WITH 1/2/3 VERTICAL MULTISTAGE CENTRIFUGAL PUMPS

C3

PAG. 346



## 1/2/3 KV 3 - 6 - 10

SETS WITH 1/2/3 VERTICAL MULTISTAGE PUMPS

C3

PAG. 347



## 1/2/3/4 NKV

FIXED SPEED PRESSURISATION UNITS

C2

PAG. 348



## 2 NKV 10/15/20 EBOX

PRESSURIZATION GROUPS WITH 2 MULTISTAGE CENTRIFUGAL PUMPS WITH A VERTICAL AXIS

C2

PAG. 349



## 1/2/3 NKP-G / K

SETS WITH CENTRIFUGAL PUMPS K - NKP-G

C4

PAG. 350



## 1 KDN COMPACT

FIRE - FIGHTING BOOSTER SETS UNI EN12845 WITH ELECTRIC PUMP AND DIESEL PUMP

EQ

ER

PAG. 353



## 1 KVT

DIESEL AND ELECTRIC EN 12845 FIRE-FIGHTING SETS WITH VERTICAL TURBINE PUMPS

ES

ET

PAG. 357



## S4 - SS6 - SS7 - SS8

FIRE-FIGHTING PUMP UNITS TO EN 12845 WITH VERTICAL NKV PUMPS

C5

PAG. 362



## 1/2 NKV

FIRE-FIGHTING PUMP UNITS TO EN 12845 WITH VERTICAL NKV PUMPS

C5

PAG. 364



## ACCESSORIES

PAG. 367

# 2 ESYBOX WITH ESYTWIN

## ELECTRONIC PRESSURIZATION SET



ESYBOX + ESYTWIN is the electronic water pressurization set for domestic and residential environments.

The installation of 2 ESYBOX + ESYTWIN does not require any additional components. It consists of two multistage self-priming pumps with inverter electronics, pressure and flow sensors, adjustable high resolution LCD display, and 2 litre built-in expansion vessel for each pump.

The water cooled motor, the sound-proofing ABS protection guards, the anti-vibration feet and the electronics, make this a completely silent (45 dB) and compact product.

The wireless device facilitates the creation of pressurisation sets and the connection to other DAB devices.

**The kit consists of two ESYBOX and one ESYTWIN. The components are supplied disassembled.**

**Protection class** IP X4

**Insulation class** F

**Pumped Liquid** clean, free of solids and abrasives, non-viscous, non-aggressive, non-crystallised and chemically neutral.

**Maximum temperature of liquid** 40 °C

**Maximum ambient temperature** 50 °C

**Maximum suction capacity** self-priming to 8 metres.

**Maximum operating pressure** 8 bar (800 kPa).

**D+CONNECT** PAG. 5

MODEL	CODE	ELECTRICAL DATA			HYDRAULIC DATA																DNA GAS	DNM GAS	WEIGHT KG								
		VOLTAGE 50 - 60 Hz	P1 MAX 2 x kW	I MAX 2 x HP	I MAX 2 x A	Q=m <sup>3</sup> /h	0	1,2	2,4	3,6	4,8	6,0	7,2	8,4	9,6	10,8	12	13,2	14,4	Q=l/min				0	20	40	60	80	100	120	140
<b>KIT 2 ESYBOX + ESYTWIN</b>	<b>60170272</b>	1x220-240 V~	1,55	2,1	10	H (m)	65	63,5	61,5	59,5	57	53	48	41,5	35	27,5	19	10	2	1" 1/4	1" 1/4	66									

### APPLICATIONS



### Esytwin

Small and large apartment complexes up to 9 floors and a maximum of 17 apartments.\*

\*Indicative data. Please refer to the technical catalogue or DNA for correct sizing.

### CERTIFICATIONS



### SUITABLE FOR PUMPING WATER FROM:



WELLS DOWN TO 8 M DEEP

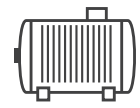

RAINWATER COLLECTION TANKS



TANKS



AQUEDUCT where permitted by law

SINGLE ESYBOX DIMENSIONS  
**57 x 27 x 35 cm**

SOUND PRESSURE\*\* **43 db(A)**



+

KIT DIMENSIONS  
**73 x 75 x 35 cm**



**1000€**

SAVINGS PER YEAR\*  
ON ELECTRICITY BILLS

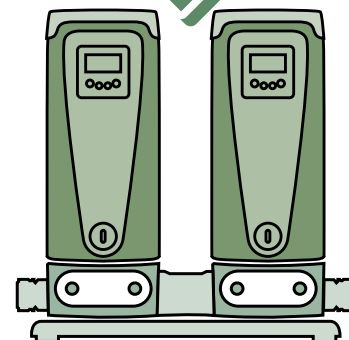

\*Compared to a traditional booster set in terms of medium usage conditions.

\*\* Sound pressure measured at 1 meter distance in free field

discover **ESYLINE**  
<https://esyline.dabpumps.com>



# 1/2/3 KVC AD

VARIABLE SPEED PRESSURISATION UNITS WITH ACTIVE DRIVER PLUS



1-2-3 KVC A.D. are **variable speed** pressurisation units with 1, 2 or 3 vertical axis multistage centrifugal pumps particularly suited for domestic use, and small civil or industrial systems. Thanks to the use of the Active Driver Plus inverter, they offer performance features capable of automatically adapting to the different needs of the systems to meet the **constant pressure** requirements of modern system engineering solutions. The constant pressure adjustment is a requirement in the most varied sectors: Water pipelines, Irrigation, Industry, Hotel, Residential building, Spas. **Their main features are reliability, simple operation, and minimum maintenance requirements.**

Construction features – main components:

- 1 to 3 KVC vertical axis multistage electric pumps (up to 4 pumps on request)
- Galvanized sheet steel base, complete with 4 anti-vibration rubber feet
- Suction and delivery manifolds in stainless steel
- 1 to 3 Active Driver Plus inverters on the delivery port of each pump
- 1 8-litre expansion vessel for each unit (for version 85/120 of 18 litres)
- 1 protection unit for units with 2 and 3 pumps

**Operating range** from 0.5 to 36 m<sup>3</sup>/h

**Pumped liquid** clean, free of solids and abrasives, non-viscous, non-aggressive, non-crystallised and chemically neutral, with properties similar to water.

**Liquid temperature range** from 0 °C to +40 °C

**Maximum ambient temperature** +40°C

**Maximum operating pressure** PN12 (12 bar)

**Protection class** IP44

**Special executions on request** up to 4 pumps and voltages and frequencies not on the general catalogue, available on request

**Up to 4 pumps on request**

**All the domestic units with Active Driver Plus have 1 8-litre expansion vessel and suction manifolds in AISI 304 stainless steel.**



PAG. 5

AD PLUS  
PAG. 25

ACCESSORIES  
PAG. 367

## 1 KVC AD

MODEL	CODE	ELECTRICAL DATA			HYDRAULIC DATA		Ø		WEIGHT Kg
		VOLTAGE 50 Hz	P2 NOMINAL		Q m <sup>3</sup> /h	H m	A	M	
			KW	HP					
1 KVC A.D. 75/50 M	60122640	1 X 230 V ~	1,5	2	0,5-2,4-4,8	94-81-40	1" ¼	1" ¼	39
1 KVC A.D. 65/80 M	60122644	1 X 230 V ~	2,2	3	0,7-4,8-9	88-71-31	1" ¼	1" ¼	40
1 KVC A.D. 35/120 M	60122645	1 X 230 V ~	1,1	1,5	1,2-6-12	46-37-12	1" ¼	1" ¼	34
1 KVC A.D. 45/120 M	60122646	1 X 230 V ~	1,85	2,5	1,2-6-12	62-52-17	1" ¼	1" ¼	35
1 KVC A.D. 60/120 T	60122647	3 X 400 V ~	2,2	3	1,2-6-12	78-63-25	1" ¼	1" ¼	39
1 KVC A.D. 85/120 T	60122649	3 X 400 V ~	3	4	1,2-6-12	112-90-34	1" ¼	1" ¼	42

## 2 KVC AD

MODEL	CODE	ELECTRICAL DATA				HYDRAULIC DATA		Ø		WEIGHT Kg
		VOLTAGE 50 Hz	P2 NOMINAL		Q m <sup>3</sup> /h	H m	A	M		
			kW x 2	HP x 2						
2 KVC A.D. 30/50 M	60122650	1 X 230 V ~	0,55	0,75	0,5-4,8-9,6	41-35-17	2"	2"	76	
2 KVC A.D. 55/50 M	60122651	1 X 230 V ~	1	1,36	0,5-4,8-9,6	68-58-29	2"	2"	83	
2 KVC A.D. 75/50 T	60122655	3 X 400 V ~	1,5	2	0,5-4,8-9,6	94-81-40	2"	2"	91	
2 KVC A.D. 30/80 M	60122656	1 X 230 V ~	0,9	1,2	0,7-9,6-18	37-30-11	2"	2"	80	
2 KVC A.D. 30/80 T	60122657	3 X 400 V ~	1	1,3	0,7-9,6-18	37-30-11	2"	2"	80	
2 KVC A.D. 45/80 M	60122659	1 X 230 V ~	1,1	1,5	0,7-9,6-18	65-53-21	2"	2"	89	
2 KVC A.D. 45/80 T	60122660	3 X 400 V ~	1,1	1,5	0,7-9,6-18	65-53-21	2"	2"	89	
2 KVC A.D. 65/80 T / N	60122661	3 X 400 V ~ + N	2,2	3	0,7-9,6-18	88-71-31	2"	2"	93	
2 KVC A.D. 65/80 T	60122662	3 X 400 V ~	2,2	3	0,7-9,6-18	88-71-31	2"	2"	93	
2 KVC A.D. 35/120 M	60122663	1 X 230 V ~	1,1	1,5	1,2-12-24	46-37-12	2"	2"	81	
2 KVC A.D. 45/120 M	60122665	1 X 230 V ~	1,85	2,5	1,2-12-24	62-52-17	2"	2"	83	
2 KVC A.D. 45/120 T	60122666	3 X 400 V ~	1,85	2,5	1,2-12-24	62-52-17	2"	2"	83	
2 KVC A.D. 60/120 T	60122667	3 X 400 V ~	2,2	3	1,2-12-24	78-63-25	2"	2"	89	
2 KVC A.D. 70/120 T	60122668	3 X 400 V ~	3	4	1,2-12-24	95-78-31	2"	2"	95	
2 KVC A.D. 85/120 T	60122669	3 X 400 V ~	3	4	1,2-12-24	112-90-34	2"	2"	97	

# 1/2/3 KVC AD

VARIABLE SPEED PRESSURISATION UNITS WITH ACTIVE DRIVER PLUS



## 3 KVC AD

MODEL	CODE	ELECTRICAL DATA			HYDRAULIC DATA		Ø		WEIGHT Kg
		VOLTAGE 50 Hz	P2 NOMINAL		Q m³/h	H m	A	M	
			kW x 3	HP x 3					
3 KVC A.D. 30/50 M	60122670	1 X 230 V ~	0,55	0,75	0,5-7,2-14,4	41-35-17	2" ½	2" ½	97
3 KVC A.D. 75/50 T / N	60122672	3 X 400 V ~ + N	1,5	2	0,5-7,2-14,4	94-81-40	2" ½	2" ½	97
3 KVC A.D. 30/80 T / N	60122673	3 X 400 V ~ + N	0,9	1,2	0,7-14,4-27	37-30-11	2" ½	2" ½	97
3 KVC A.D. 40/80 T / N	60140189	3 X 400 V ~ + N	1	1,3	0,7-14,4-27	50-39-13	2" ½	2" ½	97
3 KVC A.D. 45/80 T / N	60122674	3 X 400 V ~ + N	1,1	1,5	0,7-14,4-27	65-53-21	2" ½	2" ½	97
3 KVC A.D. 65/80 T / N	60122675	3 X 400 V ~ + N	2,2	3	0,7-14,4-27	88-71-31	2" ½	2" ½	97
3 KVC A.D. 35/120 T	60122677	3 X 400 V ~	1,1	1,5	1,2-18-36	46-37-12	2" ½	2" ½	156
3 KVC A.D. 45/120 T / N	60122678	3 X 400 V ~ + N	1,85	2,5	1,2-18-36	62-52-17	2" ½	2" ½	156
3 KVC A.D. 45/120 T	60122679	3 X 400 V ~	1,85	2,5	1,2-18-36	62-52-17	2" ½	2" ½	153
3 KVC A.D. 60/120 T	60122680	3 X 400 V ~	2,2	3	1,2-18-36	78-63-25	2" ½	2" ½	153
3 KVC A.D. 70/120 T	60122682	3 X 400 V ~	3	4	1,2-18-36	95-78-31	2" ½	2" ½	153
3 KVC A.D. 85/120 T	60122683	3 X 400 V ~	3	4	1,2-18-36	112-90-34	2" ½	2" ½	153

<sup>(1)</sup> Available on request 3x400 V Three-phase version without neutral wire

The unit is supplied assembled and tested in a sturdy cardboard packaging on wooden pallet and with instruction leaflet with electric diagram.

# 2 JET AD / 2 EURO AD / 2 EUROINOX AD

VARIABLE SPEED PRESSURISATION UNITS WITH ACTIVE DRIVER PLUS



2JET A.D. – 2EURO A.D. – 2EUROINOX A.D. are **variable speed** pressurisation units with 2 horizontal axis centrifugal pumps particularly suited for domestic use, and small civil or industrial systems. Thanks to the use of the Active Driver Plus inverter, they offer performance features capable of automatically adapting to the different needs of the systems to meet the constant pressure requirements of modern system engineering solutions. The **constant pressure** adjustment is a requirement in the most varied sectors:

Water pipelines, Irrigation, Industry, Hotel, Residential building, Spas. **Their main features are reliability, simple operation, and minimum maintenance requirements.**

Construction features – main components:

- **2 JET A.D.** has 2 JET self-priming horizontal axis pumps with cast iron pump body
- **2 EURO A.D.** has 2 EURO self-priming horizontal axis pumps with cast iron pump body
- **2 EUROINOX A.D.** has 2 EUROINOX self-priming horizontal axis multistage pumps with stainless steel pump body
- Tropicalized sheet steel base, complete with 4 anti-vibration rubber feet
- Suction and delivery manifolds in galvanized steel (in stainless steel for 2EUROINOX A.D.)
- 2 Active Driver Plus inverters on the delivery port of each pump
- 1 8-litre expansion vessel for each unit
- 1 protection control unit

**Operating range** from 0.4 to 15 m<sup>3</sup>/h

**Pumped liquid** clean, free of solids and abrasives, non-viscous, non-aggressive, non-crystallised and chemically neutral, with properties similar to water.

**Liquid temperature range** from 0 °C to +40 °C

**Maximum ambient temperature** +40°C

**Maximum operating pressure** PN10 (10 bar)

**Protection class** IP44

**Special executions on request** voltages and/or frequencies not on the general catalogue, available on request

**Including 1 8-litre expansion vessel**



D+CONNECT

PAG. 5

AD PLUS  
PAG. 25

ACCESSORIES  
PAG. 367

## 2 JET AD

MODEL	CODE	ELECTRICAL DATA			HYDRAULIC DATA		Ø		WEIGHT Kg
		VOLTAGE 50 Hz	P2 NOMINAL		Q m <sup>3</sup> /h	H m	A	M	
			kW X 2	HP X 2					
2JET AD 132 M	500140040	1 X 230 V ~	1	1,36	0,6-9,6	45,6-27,2	2"	1"½	56
2JET AD 151 M	500140070	1 X 230 V ~	1,1	1,5	0,6-9	58-38	2"	1"½	96
2JET AD 251 M	500140090	1 X 230 V ~	1,85	2,5	0,6-14,4	60-34,2	2"	1"½	105

## 2 EURO/EUROINOX AD

MODEL	CODE	ELECTRICAL DATA			HYDRAULIC DATA		Ø		WEIGHT Kg
		VOLTAGE 50 Hz	P2 NOMINAL		Q m <sup>3</sup> /h	H m	A	M	
			kW x 2	HP x 2					
2EURO AD 40/80 M	500140280	1 X 230 V ~	1	1,36	0,6-14,4	58-16	2"	1"½	57
2EUROINOX AD 40/80 M	500140380	1 X 230 V ~	1	1,36	0,6-14,4	58-14	2"	1"½	57
2EURO AD 50/50 M	500140260	1 X 230 V ~	1	1,36	0,6-9,6	68-26,5	2"	1"½	57
2EUROINOX AD 50/50 M	500140360	1 X 230 V ~	1	1,36	0,6-9,6	68-26	2"	1"½	57

# 2/3 KVCXE MCE/P DCONNECT

VARIABLE SPEED BOOSTER SET WITH MCE-P VARIABLE FREQUENCY DRIVE AND DCONNECT

**NEW**



Booster set with 2 or 3 KVCX pumps with one MCE-P variable frequency drive for pump installed as standard. The booster set is designed to increase pressure in commercial building service and for activities in agriculture and irrigation. Limited size thanks to the use of vertical pumps. There is one expansion tank per group. Base in galvanized sheet metal with anti-vibration rubber feet. Inlet and outlet manifolds in galvanized steel. Suction check valves for each pump. Possibility of remote control thanks to the DConnect service.

**DConnect Box (installed in a IP 65 panel) included as standard.** The cloud service is manageable from the internetofpumps.com website or from the DConnect App (for Android or iOS) it is possible to control installations even remotely and receive alarms in real time through an extremely functional and clear user interface.

**Operating range** from 0,5 to 36 m<sup>3</sup>/h with head of up to 112 m

**Pumped liquid** Clean, free of solids and abrasives, non-viscous, non-aggressive, non-crystallised and chemically neutral

**Liquid temperature range** from 0°C to +40°C

**Maximum ambient temperature** +40°C

**Maximum operating pressure** 12 bar / 1200 kPa

**Protection class** IP55

**Special executions on request** different voltages or frequencies, units with up to four pumps

**D CONNECT**

PAG. 5

MCE/P  
PAG. 23

ACCESSORIES  
PAG. 367

MODEL	CODE	ELECTRICAL DATA			HYDRAULIC DATA		Ø		WEIGHT Kg
		VOLTAGE 50 Hz	P2 NOMINAL		Q m <sup>3</sup> /h	H bar	A	M	
			KW X 2	HP X 2					
2KVCXE 30/80 T+N MCE/P DCONNECT	60198585	3 X 400 V ~ + N	2 x 0,8	2 x 1,1	07-9,6-18	37-30-11	2"	2"	80
2KVCXE 45/80 T+N MCE/P DCONNECT	60198586	3 X 400 V ~ + N	2 x 1,1	2 x 1,5	0,7-9,6-18	65-53-21	2"	2"	90
2KVCXE 35/120 T+N MCE/P DCONNECT	60198587	3 X 400 V ~ + N	2 x 1,1	2 x 1,5	1,2-12-24	46-37-12	2"	2"	81
2KVCXE 45/120 T+N MCE/P DCONNECT	60198588	3 X 400 V ~ + N	2 x 1,85	2 x 2,5	1,2-12-24	62-52-17	2"	2"	85
2KVCXE 60/120 T MCE/P DCONNECT	60198589	3 X 400 V ~	2 x 2,2	2 x 3	1,2-12-24	78-63-25	2"	2"	90
3KVCXE 45/120 T+N MCE/P DCONNECT	60198591	3 X 400 V ~ + N	3 x 1,85	3 x 2,5	1,2-18-36	62-52-17	2½"	2½"	160
3KVCXE 60/120 T MCE/P DCONNECT	60198592	3 X 400 V ~	3 x 2,2	3 x 3	1,2-18-36	78-63-25	2½"	2½"	160



# 1/2/3/4 NKVE 10 - 15 - 20 - 32 - 45 MCE/P

VARIABLE SPEED PRESSURISATION UNITS WITH MCE



DAB's new NKVE units with pumps are variable speed pressurisation units for the recirculation of water for pressurisation in civil and commercial environments and irrigation systems also for agriculture. The NKVE units have 1, 2, 3 or 4 NKV multi-impeller pumps with MCE-P inverter installed as standard.

For all the models with NKV 10, 15, 20 S, the parts in contact with the liquid are made of AISI 304 stainless steel. The models with NKV 32, 45 have the pump body and upper flange in cathophoretic paint coated cast iron, and the impellers, diffusers and pump liner in AISI 304 stainless steel.

The MCE-P inverter installed on the pump permits constant pressure. There is a protection controller for each unit. Delivery check valve, pressure transmitter and expansion vessel for each pump. Suction and delivery manifolds in AISI 304 stainless steel.

Version X on request with materials in contact with the water made in AISI 316 stainless steel.

The units are provided already assembled, set up and tested directly at the factory, and with the installation and maintenance instructions and test report.

Pumps coupled by rigid coupling to IE3 high energy efficiency electric motors

**Operating range** from 0.5 a 280 m<sup>3</sup>/h with head of up to 140 metres

**Pumped liquid** Clean, free of solids and abrasives, non-viscous, non-aggressive, non-crystallised and chemically neutral

**Liquid temperature range** from 0°C to +120°C (80°C with expansion vessel installed)

**Maximum ambient temperature** +50°C

**Maximum operating pressure** 16 bar / 1600 kPa

**Protection class** IP55

**Special executions on request** Yes, different voltages or frequencies or support for certain liquids, units with up to six pumps, **version X with material in contact with water in AISI 316**

**The units are provided already assembled, set up and tested directly at the factory, and with the installation and maintenance instructions and test report.**

**The units comprise 1 x 18-litre expansion vessel for each pump and delivery and suction manifolds in AISI 304 stainless steel**



IE3 ≥ 0,75 kW

**D+CONNECT**

PAG. 5

MCE/P  
PAG. 23

ACCESSORIES  
PAG. 367

## 1 NKVE 10-15-20-32-45 MCE/P

MODEL	CODE	ELECTRICAL DATA			FLOW RATE m <sup>3</sup> /h	MAX PRESSURE OBTAINABLE BAR	STANDARD PRESSURE	DNA	DNM	WEIGHT Kg	
		VOLTAGE 50 Hz	P2 NOMINAL								In A
			kW	HP							
1NKVE 10/7 S T MCE 400-50	60170559	3 X 400V ~	3	4	5,8	13	7	6	1"1/2	2"	115
1NKVE 10/9 S T MCE 400-50	60170560	3 X 400V ~	3	4	7,1	13	9	7,7	1"1/2	2"	123
1NKVE 10/12 S T MCE 400-50	60170561	3 X 400V ~	4	5,5	10,1	13	12	10	1"1/2	2"	137
1NKVE 10/15 S T MCE 400-50	60170562	3 X 400V ~	5,5	7,5	12,6	13	14	10	1"1/2	2"	150
1NKVE 15/6 S T MCE 400-50	60170563	3 X 400V ~	5,5	7,5	12,6	24	7,5	6,5	2"	2"1/2	160
1NKVE 15/8 S T MCE 400-50	60170564	3 X 400V ~	7,5	10	17	24	11	10	2"	2"1/2	175
1NKVE 15/10 S T MCE 400-50	60170565	3 X 400V ~	11	15	24,8	24	13	12	2"	2"1/2	190
1NKVE 20/5 S T MCE 400-50	60170566	3 X 400V ~	5,5	7,5	12,9	29	7	6	2"	2"1/2	165
1NKVE 20/6 S T MCE 400-50	60170567	3 X 400V ~	7,5	10	16,5	29	8,5	7,5	2"	2"1/2	200
1NKVE 20/8 S T MCE 400-50	60170568	3 X 400V ~	11	15	24,8	29	11,5	10	2"	2"1/2	220

# 1/2/3/4 NKVE 10 - 15 - 20 - 32 - 45 MCE/P

VARIABLE SPEED PRESSURISATION UNITS WITH MCE



## 2 NKVE 10-15-20- 32-45 MCE/P

MODEL	CODE	ELECTRICAL DATA				FLOW RATE m <sup>3</sup> /h	MAX PRESSURE OBTAINABLE BAR	STANDARD PRESSURE	DNA	DNM	WEIGHT Kg
		VOLTAGE 50 Hz	P2 NOMINAL		In A						
			KW	HP							
2NKVE 10/5 S T MCE 400-50	60148092	3 X 400V ~	2x2.2	2x3	2x3,8	26	5	4.0	2" ½	2" ½	186
2NKVE 10/6 S T MCE 400-50	60151474	3 X 400V ~	2x2.2	2x3	2x5,8	26	6	5.0	2" ½	2" ½	187
2NKVE 10/7 S T MCE 400-50	60148094	3 X 400 V ~	2x3	2x4	2x5,8	26	7	6	2" ½	2" ½	214
2NKVE 10/8 S T MCE 400-50	60148095	3 X 400 V ~	2x3	2x4	2x7,37	26	8	6.5	2" ½	2" ½	216
2NKVE 10/9 S T MCE 400-50	60148096	3 X 400 V ~	2x3	2x4	2x7,1	26	9	7.7	2" ½	2" ½	218
2NKVE 10/10 S T MCE 400-50	60148097	3 X 400 V ~	2x4	2x5.5	2x10,1	26	10	8.5	2" ½	2" ½	237
2NKVE 10/12 S T MCE 400-50	60148098	3 X 400 V ~	2x4	2x5.5	2x10,1	26	12	10	2" ½	2" ½	240
2NKVE 10/15 S T MCE 400-50	60148099	3 X 400 V ~	2x5.5	2x7.5	2x12,6	26	14	10	2" ½	2" ½	298
2NKVE 15/3 S T MCE 400-50	60148100	3 X 400 V ~	2x3	2x4	2x7,37	48	4	3.5	100	80	238
2NKVE 15/4 S T MCE 400-50	60148101	3 X 400 V ~	2x4	2x5.5	2x10,1	48	5	4	100	80	258
2NKVE 15/5 S T MCE 400-50	60148102	3 X 400 V ~	2x4	2x5.5	2x10,1	48	6.5	5	100	80	261
2NKVE 15/6 S T MCE 400-50	60148103	3 X 400 V ~	2x5.5	2x7.5	2x12,6	48	7.5	6.5	100	80	317
2NKVE 15/7 S T MCE 400-50	60148104	3 X 400 V ~	2x5.5	2x7.5	2x13,1	48	9	8	100	80	319
2NKVE 15/8 S T MCE 400-50	60148115	3 X 400 V ~	2x7.5	2x10	2x17	48	11	10	100	80	344
2NKVE 15/9 S T MCE 400-50	60148105	3 X 400 V ~	2x7.5	2x10	2x17,6	48	12	11	100	80	347
2NKVE 15/10 S T MCE 400-50	60148106	3 X 400 V ~	2x11	2x15	2x24,8	48	13	12	100	80	459
2NKVE 20/3 S T MCE 400-50	60148107	3 X 400 V ~	2x4	2x5.5	2x7,1	58	4	3.5	100	80	228
2NKVE 20/4 S T MCE 400-50	60148108	3 X 400 V ~	2x5.5	2x7.5	2x10,1	58	6	5	100	80	256
2NKV 20/5 S T MCE 400-50	60148109	3 X 400 V ~	2x5.5	2x7.5	2x12,9	58	7	6	100	80	260
2NKVE 20/6 S T MCE 400-50	60148110	3 X 400 V ~	2x7.5	2x10	2x16,5	58	8.5	7.5	100	80	284
2NKVE 20/7 S T MCE 400-50	60148111	3 X 400 V ~	2x7.5	2x10	2x16,5	58	10	9	100	80	286
2NKVE 20/8 S T MCE 400-50	60148112	3 X 400 V ~	2x11	2x15	2x24,8	58	11.5	10	100	80	350
2NKVE 20/9 S T MCE 400-50	60148113	3 X 400 V ~	2x11	2x15	2x24,8	58	13	12	100	80	352
2NKVE 20/10 S T MCE 400-50	60148114	3 X 400 V ~	2x11	2x15	2x24,8	58	14	13	100	80	374
2NKVE 32/2 T MCE 400-50	60166808	3 x 400 V ~	2x5,5	2x7,5	2x12,6	90	4,8	4	125	100	476
2NKVE 32/3-2 T MCE 400-50	60166809	3 x 400 V ~	2x5,5	2x7,5	2x12,6	90	6,0	5	125	100	484
2NKVE 32/3 T MCE 400-50	60166810	3 x 400 V ~	2x7,5	2x10	2x16,5	90	7,3	6	125	100	506
2NKVE 32/4 T MCE 400-50	60166811	3 x 400 V ~	2x11	2x15	2x24,8	90	9,8	8	125	100	616
2NKVE 32/5-2 T MCE 400-50	60166812	3 x 400 V ~	2x11	2x15	2x24,8	90	10,9	9	125	100	624
2NKVE 32/5 T MCE 400-50	60166813	3 x 400 V ~	2x15	2x20	2x33,6	90	12,2	10	125	100	652
2NKVE 32/6 T MCE 400-50	60166814	3 x 400 V ~	2x15	2x20	2x33,6	90	14,6	12	125	100	660
2NKVE 45/2-2 T MCE 400-50	60166815	3 x 400 V ~	2x5,5	2x7,5	2x12,6	140	3,8	3	150	125	488
2NKVE 45/2 T MCE 400-50	60166816	3 x 400 V ~	2x7,5	2x10	2x16,5	140	4,8	4	150	125	510
2NKVE 45/3 T MCE 400-50	60166817	3 x 400 V ~	2x11	2x15	2x25,1	140	7,3	6,5	150	125	620
2NKVE 45/4 T MCE 400-50	60166818	3 x 400 V ~	2x15	2x20	2x33,6	140	9,7	8,5	150	125	656

COMMAND AND  
CONTROL SYSTEMS

CIRCULATORS AND  
IN-LINE PUMPS

MULTISTAGE CENTRIFUGAL  
AND SELF-PRIMING PUMPS

SWIMMING POOL, POND AND  
SALT WATER PUMPS

CENTRIFUGAL PUMPS

SUBMERSIBLE PUMPS

SUBMERSIBLE PUMPS  
AND SUBMERSIBLE MOTORS

PRESSURE UNITS

# 1/2/3/4 NKVE 10 - 15 - 20 - 32 - 45 MCE/P

VARIABLE SPEED PRESSURISATION UNITS WITH MCE



## 3 NKVE 10-15-20-32-45 MCE/P

MODEL	CODE	ELECTRICAL DATA				FLOW RATE m <sup>3</sup> /h	MAX PRESSURE OBTAINABLE BAR	STANDARD PRESSURE	DNA	DNM	WEIGHT Kg
		VOLTAGE 50 Hz	P2 NOMINAL		In A						
			KW	HP							
3NKVE 10/5 S T MCE 400-50	60148118	3 X 400 V ~	3x2,2	3x3	3x3,8	39	5	4.0	80	80	425
3NKVE 10/6 S T MCE 400-50	60148119	3 X 400 V ~	3x2,2	3x3	3x5,8	39	6	5.0	80	80	428
3NKVE 10/7 S T MCE 400-50	60148120	3 X 400 V ~	3x3	3x4	3x5,8	39	7	6	80	80	468
3NKVE 10/8 S T MCE 400-50	60148121	3 X 400 V ~	3x3	3x4	3x7,37	39	8	6.5	80	80	471
3NKVE 10/9 S T MCE 400-50	60148122	3 X 400 V ~	3x3	3x4	3x7,1	39	9	7.7	80	80	473
3NKVE 10/10 S T MCE 400-50	60148123	3 X 400 V ~	3x4	3x5,5	3x10,1	39	10	8.5	80	80	503
3NKVE 10/12 S T MCE 400-50	60148124	3 X 400 V ~	3x4	2x5,5	3x10,1	39	12	10	80	80	508
3NKVE 10/15 S T MCE 400-50	60148125	3 X 400 V ~	3x5,5	3x7,5	3x12,6	39	14	10	80	80	593
3NKVE 15/3 S T MCE 400-50	60148126	3 X 400 V ~	3x3	3x4	3x7,37	72	4	3.5	125	100	486
3NKVE 15/4 S T MCE 400-50	60148127	3 X 400 V ~	3x4	3x5,5	3x10,1	72	5	4	125	100	516
3NKVE 15/5 S T MCE 400-50	60148128	3 X 400 V ~	3x4	3x5,5	3x10,1	72	6,5	5	125	100	520
3NKVE 15/6 S T MCE 400-50	60148129	3 X 400 V ~	3x5,5	3x7,5	3x12,6	72	7,5	6,5	125	100	605
3NKVE 15/7 S T MCE 400-50	60148130	3 X 400 V ~	3x5,5	3x7,5	3x13,1	72	9	8	125	100	608
3NKVE 15/8 S T MCE 400-50	60148131	3 X 400 V ~	3x7,5	3x10	3x17	72	11	10	125	100	645
3NKVE 15/9 S T MCE 400-50	60148132	3 X 400 V ~	3x7,5	3x10	3x17,6	72	12	11	125	100	649
3NKVE 15/10 S T MCE 400-50	60148133	3 X 400 V ~	3x11	3x15	3x24,8	72	13	12	125	100	818
3NKVE 20/3 S T MCE 400-50	60148134	3 X 400 V ~	3x4	3x5,5	3x7,1	87	4	3.5	125	100	471
3NKVE 20/4 S T MCE 400-50	60148135	3 X 400 V ~	3x5,5	3x7,5	3x10,1	87	6	5	125	100	513
3NKVE 20/5 S T MCE 400-50	60148136	3 X 400 V ~	3x5,5	3x7,5	3x12,9	87	7	6	125	100	519
3NKVE 20/6 S T MCE 400-50	60148137	3 X 400 V ~	3x7,5	3x10	3x16,5	87	8,5	7,5	125	100	556
3NKVE 20/7 S T MCE 400-50	60148138	3 X 400 V ~	3x7,5	3x10	3x16,5	87	10	9	125	100	559
3NKVE 20/8 S T MCE 400-50	60148139	3 X 400 V ~	3x11	3x15	3x24,8	87	11,5	10	125	100	655
3NKVE 20/9 S T MCE 400-50	60148140	3 X 400 V ~	3x11	3x15	3x24,8	87	13	12	125	100	658
3NKVE 20/10 S T MCE 400-5	60148141	3 X 400 V ~	3x11	3x15	3x24,8	87	14	13	125	100	691
3NKVE 32/2 T MCE 400-50	60166819	3 x 400 V ~	3x5,5	3x7,5	3x12,6	135	4,8	4	150	125	714
3NKVE 32/3-2 T MCE 400-50	60166820	3 x 400 V ~	3x5,5	3x7,5	3x12,6	135	6,0	5	150	125	726
3NKVE 32/3 T MCE 400-50	60166821	3 x 400 V ~	3x7,5	3x10	3x16,5	135	7,3	6	150	125	759
3NKVE 32/4 T MCE 400-50	60166822	3 x 400 V ~	3x11	3x15	3x24,8	135	9,8	8	150	125	924
3NKVE 32/5-2 T MCE 400-50	60166823	3 x 400 V ~	3x11	3x15	3x24,8	135	10,9	9	150	125	936
3NKVE 32/5 T MCE 400-50	60166824	3 x 400 V ~	3x15	3x20	3x33,6	135	12,2	10	150	125	978
3NKVE 32/6 T MCE 400-50	60166825	3 x 400 V ~	3x15	3x20	3x33,6	135	14,6	12	150	125	990
3NKVE 45/2-2 T MCE 400-50	60166826	3 x 400 V ~	3x5,5	3x7,5	3x12,6	210	3,8	3	200	150	732
3NKVE 45/2 T MCE 400-50	60166827	3 x 400 V ~	3x7,5	3x10	3x16,5	210	4,8	4	200	150	765
3NKVE 45/3 T MCE 400-50	60166828	3 x 400 V ~	3x11	3x15	3x25,1	210	7,3	6,5	200	150	930
3NKVE 45/4 T MCE 400-50	60166829	3 x 400 V ~	3x15	3x20	3x33,6	210	9,7	8,5	200	150	984

COMMAND AND  
CONTROL SYSTEMS

CIRCULATORS AND  
IN-LINE PUMPS

MULTISTAGE CENTRIFUGAL  
AND SELF-PRIMING PUMPS

SWIMMING POOL, POND AND  
SALT WATER PUMPS

CENTRIFUGAL PUMPS

SUBMERSIBLE PUMPS

SUBMERSIBLE PUMPS  
AND SUBMERSIBLE MOTORS

PRESSURE UNITS

# 1/2/3/4 NKVE 10 - 15 - 20 - 32 - 45 MCE/P

VARIABLE SPEED PRESSURISATION UNITS WITH MCE



## 4 NKVE 10-15-20-32-45 MCE/P

MODEL	CODE	ELECTRICAL DATA				FLOW RATE m <sup>3</sup> /h	MAX PRESSURE OBTAINABLE BAR	STANDARD PRESSURE	DNA	DNM	WEIGHT Kg
		VOLTAGE 50 Hz	P2 NOMINAL		In A						
			KW	HP							
4NKVE 10/5 S T MCE 400-50	60163261	3X 400V	4x2,2	4x3	4x4,9	52	5	4	100	80	327
4NKVE 10/6 S T MCE 400-50	60163262	3X 400V	4x2,2	4x3	4x5,4	52	6	5	100	80	571
4NKVE 10/7 S T MCE 400-50	60163263	3X 400V	4x3	4x4	4x5,8	52	7	6	100	80	624
4NKVE 10/8 S T MCE 400-50	60163264	3X 400V	4x3	4x4	4x7,1	52	8	6,5	100	80	628
4NKVE 10/9 S T MCE 400-50	60163265	3X 400V	4x3	4x4	4x7,1	52	9	7,7	100	80	631
4NKVE 10/10 S T MCE 400-50	60163266	3X 400V	4x4	4x5,5	4x10,1	52	10	8,5	100	80	671
4NKVE 10/12 S T MCE 400-50	60163267	3X 400V	4x4	4x5,5	4x10,1	52	12	10	100	80	678
4NKVE 15/3 S T MCE 400-50	60163268	3X 400V	4x3	4x4	4x7,37	96	4	3,5	150	125	648
4NKVE 15/4 S T MCE 400-50	60163269	3X 400V	4x4	4x5,5	4x10,1	96	5	4	150	125	688
4NKVE 15/5 S T MCE 400-50	60163270	3X 400V	4x4	4x5,5	4x10,1	96	6,5	5	150	125	694
4NKVE 15/6 S T MCE 400-50	60163271	3X 400V	4x5,5	4x7,5	4x12,6	96	7,5	6,5	150	125	807
4NKVE 15/7 S T MCE 400-50	60163272	3X 400V	4x5,5	4x7,5	4x13,1	96	9	8	150	125	811
4NKVE 15/8 S T MCE 400-50	60163273	3X 400V	4x7,5	4x10	4x17	96	11	10	150	125	860
4NKVE 15/9 S T MCE 400-50	60163274	3X 400V	4x7,5	4x10	4x17,6	96	12	11	150	125	865
4NKVE 15/10 S T MCE 400-50	60163275	3X 400V	4x11	4x15	4x24,8	96	13	12	150	125	919
4NKVE 20/3 S T MCE 400-50	60163276	3X 400V	4x4	4x5,5	4x7,1	116	4	3,5	150	125	628
4NKVE 20/4 S T MCE 400-50	60163277	3X 400V	4x5,5	4x7,5	4x10,1	116	6	5	150	125	684
4NKVE 20/5 S T MCE 400-50	60163278	3X 400V	4x5,5	4x7,5	4x12,9	116	7	6	150	125	692
4NKVE 20/6 S T MCE 400-50	60163279	3X 400V	4x7,5	4x10	4x16,5	116	8,5	7,5	150	125	741
4NKVE 20/7 S T MCE 400-50	60163280	3X 400V	4x7,5	4x10	4x16,5	116	10	9	150	125	745
4NKVE 20/8 S T MCE 400-50	60163281	3X 400V	4x11	4x15	4x24,8	116	11,5	10	150	125	873
4NKVE 20/9 S T MCE 400-50	60163282	3X 400V	4x11	4x15	4x24,8	116	13	12	150	125	877
4NKVE 20/10 S T MCE 400-50	60163283	3X 400V	4x11	4x15	4x24,8	116	14	13	150	125	921
4NKVE 32/2 T MCE 400-50	60166830	3 x 400 V ~	4x5,5	4x7,5	4x12,6	180	4,8	4	200	150	952
4NKVE 32/3-2 T MCE 400-50	60166831	3 x 400 V ~	4x5,5	4x7,5	4x12,6	180	6,0	5	200	150	968
4NKVE 32/3 T MCE 400-50	60166832	3 x 400 V ~	4x7,5	4x10	4x16,5	180	7,3	6	200	150	1012
4NKVE 32/4 T MCE 400-50	60166833	3 x 400 V ~	4x11	4x15	4x24,8	180	9,8	8	200	150	1232
4NKVE 32/5-2 T MCE 400-50	60166834	3 x 400 V ~	4x11	4x15	4x24,8	180	10,9	9	200	150	1248
4NKVE 32/5 T MCE 400-50	60166835	3 x 400 V ~	4x15	4x20	4x33,6	180	12,2	10	200	150	1304
4NKVE 32/6 T MCE 400-50	60166836	3 x 400 V ~	4x15	4x20	4x33,6	180	14,6	12	200	150	1320
4NKVE 45/2-2 T MCE 400-50	60166837	3 x 400 V ~	4x5,5	4x7,5	4x12,6	280	3,8	3	250	200	976
4NKVE 45/2 T MCE 400-50	60166838	3 x 400 V ~	4x7,5	4x10	4x16,5	280	4,8	4	250	200	1020
4NKVE 45/3 T MCE 400-50	60166839	3 x 400 V ~	4x11	4x15	4x25,1	280	7,3	6,5	250	200	1240
4NKVE 45/4 T MCE 400-50	60166840	3 x 400 V ~	4x15	4x20	4x33,6	280	9,7	8,5	250	200	1312

COMMAND AND  
CONTROL SYSTEMS

CIRCULATORS AND  
IN-LINE PUMPS

MULTISTAGE CENTRIFUGAL  
AND SELF-PRIMING PUMPS

SWIMMING POOL, POND AND  
SALT WATER PUMPS

CENTRIFUGAL PUMPS

SUBMERSIBLE PUMPS

SUBMERSIBLE PUMPS  
AND SUBMERSIBLE MOTORS

PRESSURE UNITS

# 2/3 NKVE 10 - 15 - 20 - 32 - 45 MCE/P DCONNECT

VARIABLE SPEED BOOSTER SET WITH MCE-P VARIABLE FREQUENCY DRIVE AND DCONNECT



**NEW**



New variable speed booster sets with MCE-P variable frequency drive for pressurization in commercial building service and for irrigation in agriculture. Booster sets with 2 or 3 NKV multi-impeller pumps. The models with NKV 10, 15, 20 S have the parts in contact with the liquid in AISI 304 stainless steel. Models with NKV 32, 45 have the pump body and upper flange in cataphorised cast iron, impellers, diffusers and pump jacket in AISI 304 stainless steel. The MCE-P variable frequency drive is installed on the pump and allows constant pressure. There is a protection switchboard per group. One check valve, one pressure transmitter and one expansion tank for each pump. Steel inlet and outlet manifolds in stainless steel AISI 304. On request it is available the X version with materials in contact with water in AISI 316 stainless steel. The booster sets are supplied assembled, set up and tested directly at the factory and complete with installation, maintenance instructions and test report. Pumps coupled by rigid coupling to a high energy efficiency electric motors (IE3).

**DConnect Box (installed in a IP 65 panel) included as standard.** The cloud service is manageable from the internetofpumps.com website or from the DConnect App (for Android or iOS) it is possible to control installations even remotely and receive alarms in real time through an extremely functional and clear user interface.

**Operating range** up to 280 m<sup>3</sup>/h with head of up to 102 metres

**Pumped liquid** Clean, free of solids and abrasives, non-viscous, non-aggressive, non-crystallised and chemically neutral

**Liquid temperature range** from 0°C to +120°C (80°C with expansion vessel installed)

**Maximum ambient temperature** +50°C

**Maximum operating pressure** 16 bar / 1600 kPa

**Protection class** IP55

**Special executions on request** Yes, different voltages or frequencies or support for certain liquids, units with up to six pumps, **version X with material in contact with water in AISI 316**

**The units are provided already assembled, set up and tested directly at the factory, and with the installation and maintenance instructions and test report.**

**The units comprise 1 x 18-litre expansion vessel for each pump and delivery and suction manifolds in AISI 304 stainless steel**



IE3 ≥ 0,75 kW

**DCONNECT**

PAG. 5

MCE/P  
PAG. 23

ACCESSORIES  
PAG. 367

## 2 NKVE 10-15-20-32-45 MCE/P E DCONNECT

MODEL	CODE	ELECTRICAL DATA				FLOW RATE m <sup>3</sup> /h	MAX PRESSURE OBTAINABLE BAR	STANDARD PRESSURE	DNA	DNM	WEIGHT Kg
		VOLTAGE 50 Hz	P2 NOMINAL		In A						
			kW	HP							
2NKVE 10/6 T MCE 400 DCONNECT	60198186	3 X 400V ~	2x2.2	2x3	2x5.4	26	6	5.0	2" ½	2" ½	187
2NKVE 10/7 T MCE 400 DCONNECT	60198580	3 X 400V ~	2x3	2x4	2x7.37	26	7	6	2" ½	2" ½	214
2NKVE 10/8 T MCE 400 DCONNECT	60198183	3 X 400V ~	2x3	2x4	2x7.37	26	8	6.5	2" ½	2" ½	216
2NKVE 10/10 T MCE 400 DCONNECT	60198581	3 X 400V ~	2x4	2x5.5	2x10.1	26	10	8.5	2" ½	2" ½	237
2NKVE 10/12 T MCE 400 DCONNECT	60198160	3 X 400V ~	2x4	2x5.5	2x10.1	26	12	10	2" ½	2" ½	240
2NKVE 15/3 T MCE 400 DCONNECT	60198167	3 X 400V ~	2x3	2x4	2x7.37	48	4	3.5	100	80	238
2NKVE 15/4 T MCE 400 DCONNECT	60198148	3 X 400V ~	2x4	2x5.5	2x10.1	48	5	4	100	80	258
2NKVE 15/5 T MCE 400 DCONNECT	60198156	3 X 400V ~	2x4	2x5.5	2x10.1	48	6.5	5	100	80	261
2NKVE 15/6 T MCE 400 DCONNECT	60198177	3 X 400V ~	2x5.5	2x7.5	13,1	48	7.5	6.5	100	80	317
2NKVE 15/7 T MCE 400 DCONNECT	60198189	3 X 400V ~	2x5.5	2x7.5	2x13.1	48	9	8	100	80	319
2NKVE 20/3 T MCE 400 DCONNECT	60198193	3 X 400V ~	2x4	2x5.5	2x10.1	58	4	3.5	100	80	228
2NKVE 20/4 T MCE 400 DCONNECT	60198197	3 X 400V ~	2x5.5	2x7.5	2x13.1	58	6	5	100	80	256
2NKV 20/5 T MCE 400 DCONNECT	60198171	3 X 400V ~	2x5.5	2x7.5	2x13.1	58	7	6	100	80	260
2NKVE 32/3 T MCE 400 DCONNECT	60198176	3 x 400V ~	2x7,5	2x10	2x17,6	90	7,3	6	125	100	506
2NKVE 45/3 T MCE 400 DCONNECT	60198256	3 x 400V ~	2x11	2x15	2x25,5	140	7,3	6,5	150	125	620

# 2/3 NKVE 10 - 15 - 20 - 32 - 45 MCE/P DCONNECT

VARIABLE SPEED BOOSTER SET WITH MCE-P VARIABLE FREQUENCY DRIVE AND DCONNECT



MODEL	CODE	ELECTRICAL DATA			FLOW RATE m <sup>3</sup> /h	MAX PRESSURE OBTAINABLE BAR	STANDARD PRESSURE	DNA	DNM	WEIGHT Kg	
		VOLTAGE 50 Hz	P2 NOMINAL								In A
	kW		HP								
3NKVE 10/9 T MCE 400 DCONNECT	60198290	3 X 400 V ~	3x3	3x4	3x7.37	39	9	7.7	80	80	473
3NKVE 10/10 T MCE 400 DCONNECT	60198239	3 X 400 V ~	3x4	3x5.5	3x10.1	39	10	8.5	80	80	503
3NKVE 10/15 T MCE 400 DCONNECT	60198582	3 X 400 V ~	3x5.5	3x7.5	3x13.1	39	14	10	80	80	593
3NKVE 15/3 T MCE 400 DCONNECT	60198293	3 X 400 V ~	3x3	3x4	3x7.37	72	4	3.5	125	100	486
3NKVE 15/4 T MCE 400 DCONNECT	60198291	3 X 400 V ~	3x4	3x5.5	3x10.1	72	5	4	125	100	516
3NKVE 15/5 T MCE 400 DCONNECT	60198269	3 X 400 V ~	3x4	3x5.5	3x10.1	72	6.5	5	125	100	520
3NKVE 15/7 T MCE 400 DCONNECT	60198583	3 X 400 V ~	3x5.5	3x7.5	3x13.1	72	9	8	125	100	608
3NKVE 20/4 T MCE 400 DCONNECT	60198282	3 X 400 V ~	3x5.5	3x7.5	3x13.1	87	6	5	125	100	513
3NKVE 20/5 T MCE 400 DCONNECT	60198245	3 X 400 V ~	3x5.5	3x7.5	3x13.1	87	7	6	125	100	519
3NKVE 20/7 T MCE 400 DCONNECT	60198584	3 X 400 V ~	3x7.5	3x10	3x17.6	87	10	9	125	100	559
3NKVE 32/3 T MCE 400 DCONNECT	60198260	3 x 400 V ~	3x7,5	3x10	3x17,6	135	7,3	6	150	125	759

COMMAND AND  
CONTROL SYSTEMS

CIRCULATORS AND  
IN-LINE PUMPS

MULTISTAGE CENTRIFUGAL  
AND SELF-PRIMING PUMPS

SWIMMING POOL, POND AND  
SALT WATER PUMPS

CENTRIFUGAL PUMPS

SUBMERSIBLE PUMPS

SUBMERSIBLE PUMPS  
AND SUBMERSIBLE MOTORS

PRESSURE UNITS

# 2 JET

## SETS WITH 2 SELF-PRIMING PUMPS



DAB's 2 Jet is a pressure set with 2 x Jet self-priming pumps and EBox Plus electric panel (with display) installed as standard, designed for pressurisation and collection from the subsoil in domestic, residential, civil and commercial applications.

The Jet self-priming pumps can draw water from wells (up to 8 metres deep) even in the presence of air or sandy impurities.

The EBox Plus panel can switch operation of the pumps at each start-up and provides dry run protection when combined with a float or pressure switch. Air supply connector included. Each Jet pump has an expansion vessel. The units are provided already assembled, set up and tested directly at the factory, and with the installation and maintenance instructions and test report.

**Operating range** from 1 to 14.4 m<sup>3</sup>/h, with head up to 62 m

**Pumped liquid** Clean, free of solids and abrasive substances, non-viscous, non-aggressive, non-crystallised and chemically neutral

**Liquid temperature range**  
From +0 °C to +40 °C

**Maximum ambient temperature** +40°C

**Maximum operating pressure** 10 bar /1000 kPa

**Special executions on request**

Yes, different voltages or frequencies

**Protection class** IP 44 (IP55 at the terminal board)

Including 2 18-litre expansion vessels



IE3 ≥ 0,75 kW

**D+CONNECT** PAG. 5

MODEL	CODE	ELECTRICAL DATA			HYDRAULIC DATA		Ø		WEIGHT Kg
		VOLTAGE 50 Hz	P2 NOMINAL		Q m <sup>3</sup> /h	H m	A	M	
			kW X2	HP X 2					
<b>2 JET 102 M</b>	500121140	1 X 230V ~	0,75	1	0,6-7,2	47-25,8	2"	1 1/2"	71
<b>2 JET 132 M</b>	500121160	1 X 230V ~	1	1,36	0,6-9,6	45,6-27,2	2"	1 1/2"	77
<b>2 JET 151 M</b>	500121060	1 X 230V ~	1,1	1,5	0,6-9	58-38	2"	1 1/2"	101
<b>2 JET 151 T</b>	60179945	3 X 400V ~	1,1	1,5	0,6-9	58-38	2"	1 1/2"	105
<b>2 JET 251 M</b>	500121100	1 X 230V ~	1,85	2,5	0,6-14,4	60-34,2	2"	1 1/2"	75
<b>2 JET 251 T</b>	60179946	3 X 400V ~	1,85	2,5	0,6-14,4	60-34,2	2"	1 1/2"	108

The set is supplied assembled, tested, in a strong carton on a wooden pallet complete with instruction leaflet and wiring diagram.  
Available on request the 3x230 V version.

# 2 EURO / 2 EUROINOX

SETS WITH 2 HORIZONTAL MULTISTAGE EURO



DAB's 2 Euro and 2 Euroinox are pressurisation units with horizontal multi-impeller pumps for domestic, residential, civil and commercial applications.

2 Euro has the pump body in cast iron, 2 Euroinox is self-priming with pump body in stainless steel.

The units consist of two pumps, two expansion vessels and an EBox panel with display (EBox Plus) that can switch operation of the pumps at each start-up and provide dry run protection when combined with a float or pressure switch.

Air supply connector included. Each pump has an expansion vessel. The units are provided already assembled, set up and tested directly at the factory, and with the installation and maintenance instructions and test report.

**Operating range** from 1 to 14,5 m<sup>3</sup>/h with head up to 72 m

**Pumped liquid** Clean, free of solids and abrasive substances, non-viscous, non-aggressive, non-crystallised and chemically neutral

**Liquid temperature range**  
From +0 °C to +40 °C

**Maximum ambient temperature** +40°C  
Maximum operating pressure 10 bar / 1000 kPa

**Special executions on request** Yes, different voltages or frequencies

**Protection class** IP 44 (IP55 at the terminal board)

Including 2 18-litre expansion vessels



IE3 ≥ 0,75 kW

D+CONNECT PAG. 5

## 2 EURO

MODEL	CODE	ELECTRICAL DATA			HYDRAULIC DATA		Ø		WEIGHT Kg
		VOLTAGE 50 Hz	P2 NOMINAL		Q m <sup>3</sup> /h	H m	A	M	
			KW X2	HP X 2					
2 EURO 40/50 M	500127150	1 X 230 V ~	0,75	1	0,6-9,6	55-19	2"	1 1/2"	57
2 EURO 50/50 M	500127200	1 X 230 V ~	1	1,36	0,6-9,6	68-26,5	2"	1 1/2"	56
2 EURO 40/80 M	500127300	1 X 230 V ~	1	1,36	0,6-14,4	58-16	2"	1 1/2"	56
2 EURO 40/80 T	60179949	3 X 400 V ~	1	1,36	0,6-14,4	58-16	2"	1 1/2"	58

## 2 EUROINOX

MODEL	CODE	ELECTRICAL DATA			HYDRAULIC DATA		Ø		WEIGHT Kg
		VOLTAGE 50 Hz	P2 NOMINAL		Q m <sup>3</sup> /h	H m	A	M	
			KW X2	HP X 2					
2 EUROINOX 40/50 M	500128150	1 X 230 V ~	0,75	1	0,6-9,6	55-19	2"	1 1/2"	57
2 EUROINOX 50/50 M	500128200	1 X 230 V ~	1	1,36	0,6-9,6	68-26,5	2"	1 1/2"	57
2 EUROINOX 40/80 M	500128300	1 X 230 V ~	1	1,36	0,6-14,4	58-16	2"	1 1/2"	57
2 EUROINOX 40/80 T	60179954	3 X 400 V ~	1	1,36	0,6-14,4	58-16	2"	1 1/2"	58

The set is supplied assembled, tested, in a strong carton on a wooden pallet complete with instruction leaflet and wiring diagram. Available on request the 3x230 V version.



## 2 KI

### PRESSURE SETS WITH 2 AISI 304 STAINLESS STEEL 2KI SINGLE IMPELLER CENTRIFUGAL PUMPS



The pressurisation units are particularly suited for thermal waters, industrial washing and civil and industrial pressurisation (cold and hot liquids, and coolants), and for applications with hot water up to 90°C. They use 2 AISI 304 stainless steel KI single-stage centrifugal pumps that guarantee excellent corrosion resistant (special mechanical seals for aggressive liquids are available on request). The main features of the 2KI units are reliability, simple operation, and minimum maintenance requirements.

#### CONSTRUCTION FEATURES:

##### HYDRAULIC SECTION

- 2 AISI 304 stainless steel KI centrifugal electric pumps;
- Base, complete with 4 anti-vibration rubber feet;
- Threaded suction and delivery manifolds in AISI 304 stainless steel;
- 1 18-litre expansion vessel;
- Ball valves with unions on the suction and delivery ports of each pump;
- Check valve on the suction port of each pump;
- 2 AISI 304 stainless steel plug for closing the manifolds;
- 1 pressure transmitter on the delivery manifold (pressure detection).

##### ELECTRICAL SECTION

IP 55 protection class self-extinguishing, shock-resistant plastic EBox electric control panel with display on the delivery manifold of the unit. The control panel protects the electric pumps and controls the sequence, keeping the system at a pressure value already preset. The average pressure value can be changed at the panel front display. The pump starting order is switched at each operating cycle.

#### Operating range

from 0.5 to 22 m<sup>3</sup>/h with head up to 40 m

**Pumped liquid** clean, free of solids and abrasives, non-viscous, non-crystallised and chemically neutral, with properties similar to water.

#### Liquid temperature range

from -10 °C to +90 °C

**Maximum ambient temperature** +40°C

**Maximum operating pressure** PN 8 (8 bar)

**Protection class** IP55

#### Special executions on request

- Special voltages (Three-phase 230-415V / 50Hz)
- Special manifolds in AISI 316 stainless steel
- Special mechanical seals (Ceramic/Carbon/FKM-Viton - SiC/SiC/FKM-Viton)FKM-Viton)

The 2KI sets comprise **1 18-litre expansion vessel for each pump and delivery and suction manifolds in AISI 304 stainless steel**



**D+CONNECT**

PAG. 5

MODEL	CODE	ELECTRICAL DATA				HYDRAULIC DATA		Ø		WEIGHT Kg
		VOLTAGE 50 Hz	P1 MAX kW X2	P2 NOMINAL		Q m <sup>3</sup> /h	H m	A	M	
				kW X2	HP X2					
2KI 30/90 M 230/50	60188354	1x220-240 V	1,4	0,75	1	0-10-17	31-25-17	2"	1 1/2"	49
2KI 30/120 M 230/50	60188902	1x220-240 V	1,55	1	1,36	0-10-20	32-27-18	2"	1 1/2"	51
2KI 40/120 M 230/50	60188904	1x220-240 V	2,2	1,5	2	0-11-22	40-35-23	2"	1 1/2"	57

# 2 K

## SETS WITH CENTRIFUGAL PUMPS TWIN IMPELLER



DAB's 2 K is a pressurisation unit comprising two K double impeller pumps, two expansion vessels and an EBox panel with display installed as standard.

Units designed for pressurisation in civil and commercial environments and irrigation systems also for agriculture.

The 2 K unit is ideal for increasing the pressure of water and for irrigation systems also for agriculture. The EBox Plus panel (with display) can, among other functions, switch operation of the pumps at each start-up and provide dry run protection when combined with a float or pressure switch. Air supply connector included.

The units are provided already assembled, set up and tested directly at the factory, and with the installation and maintenance instructions and test report.

**Operating range** from 1 to 19 m<sup>3</sup>/h with head up to 85 m

**Pumped liquid** Clean, free of solids and abrasive substances, non-viscous, non-aggressive, non-crystallised and chemically neutral

**Liquid temperature range** from -10 °C to +70 °C

**Maximum ambient temperature** +40°C

**Maximum operating pressure** 10 bar / 1000 kPa

**Special executions on request**

Yes, different voltages or frequencies on request in the place of the pressure sensor

**Protection class** IP 44 (IP55 at the terminal board)

Including 2 18-litre expansion vessels



IE3 ≥ 0,75 kW

**D+CONNECT** PAG. 5

MODEL	CODE	ELECTRICAL DATA			HYDRAULIC DATA		Ø		WEIGHT Kg
		VOLTAGE 50 Hz	P2 NOMINAL		Q m <sup>3</sup> /h	H m	A	M	
			kW X 2	HP X 2					
2 K35/40 M	500124020	1 X 230V ~	0,75	1	1,2-11	41,5-16	2"	1½"	64
2 K45/50 M	500124040	1 X 230V ~	1,1	1,5	1,2-13,2	49-25	2"	1½"	80
2 K45/50 T	60179955	3 X 400V ~	1,1	1,5	1,2-13,2	49-25	2"	1½"	80
2 K55/50 M	500124060	1 X 230V ~	1,85	2,5	2-12,0	58-34	2"	1½"	80
2 K55/50 T	60179956	3 X 400V ~	1,85	2,5	2-12,0	58-34	2"	1½"	80
2 K55/100 T	60179957	3 X 400V ~	2,2	3	1,8-19,2	60-36	2"½	2"½	130
2 K66/100 T	60179958	3 X 400V ~	3	4	1,8-19,2	71-47	2"½	2"½	139
2 K90/100 T	60179959	3 X 400V ~	4	5,5	1,8-19,2	83-58	2"½	2"½	138

The set is supplied assembled, tested, in a strong carton on a wooden pallet complete with instruction leaflet and wiring diagram.

# AQUATWIN TOP

## PRESSURIZATION GROUP FOR RAINWATER RECOVERY SYSTEM



Pressurization group for systems management and reuse of rainwater with 2 centrifugal pumps type EUROINOX or JETINOX. Complete with water reserve tank up to 150L implemented in the system. For medium to large systems.

### CONTROL PANEL

Automatic inverter for exchanging the order of pump starting at each start. General breaker switch. PLC for the management and monitoring of reserve water supplies. Low voltage auxiliary circuit complete with transformer, protection fuses and a three-way electric valves for switching rainwater tanks - public water network.

AQUATWIN comes with a black, cataforizzato steel structure, tank capacity up to 150L public network water accumulation, stainless steel storage delivery manifold with shut-off valve, expansion tank up to 8L. Including "Air gap", connection system to public water network according to UNI EN 1717: Protection against pollution of potable water in water installations and requirements of devices to prevent pollution from backflow.

**Line voltage** 230 V single phase.

**Voltage of electric pump** 230 V single phase.

**Power frequency** 50 Hz.

**Installation** vertical only.

**Pumped liquid temperature range** from 0 °C to +40 °C.

**Maximum ambient temperature** 40 °C.

**Max pressure** 5,5bar.

**Pumped liquid** clean, free from solids.

**Pressure regulation range** 3 to 5 bar.

**Suction diameter (DNA)** 1"

**Delivery diameter (DNM)** 1"1/2

**Protection class** IP44.

MODEL	CODE	ELECTRICAL DATA			HYDRAULIC DATA		Ø		WEIGHT Kg
		VOLTAGE 50 Hz	P2 NOMINAL		Q m <sup>3</sup> /h	H m	A	M	
			kW X 2	HP X 2					
AQUATWIN TOP 132	60162096	1 X 230V ~	1	1,36	0,6-9,6	47,5-27,5	1"	1"½	113
AQUATWIN TOP 4050	60162095	1 X 230V ~	0,75	1	0,6-9,6	57,6-19	1"	1"½	113
AQUATWIN TOP 4080	60151634	1 X 230V ~	1	1,36	0,6-14,2	59-16,5	1"	1"½	115

# 1/2/3 KVC

SET WITH 1-2-3 VERTICAL MULTISTAGE CENTRIFUGAL PUMPS



1-2-3 KVC are fixed speed pressurisation units with 1, 2 or 3 vertical axis multistage centrifugal pumps particularly suited for domestic use, and small civil or industrial systems. The use of the electric panel (units with 2 and 3 pumps) guarantees automatic switching of the pumps, control at the main switch and protection of the electric pumps with thermal magnetic circuit breakers. EBox panel with display for the 2KVC units

**Their main features are reliability, simple operation, and minimum maintenance requirements.**

Construction features – main components:

1 to 3 KVC vertical axis multistage electric pumps  
Tropicalized sheet steel base, complete with 4 anti-vibration rubber feet

Suction and delivery manifolds in stainless steel

Control:

-1KVC --> the single-phase version has a 2-pole pressure switch with power input plug; while the three-phase version has a remote motor protector control panel with reset button.

- 2KVC --> with EBox D panel with display.

- 3KVC --> with E3G panel with pressure switches.

**Operating range** from 1 to 36 m<sup>3</sup>/h

**Pumped liquid** Clean, free of solids and abrasives, non-viscous, non crystallised and chemically neutral, with properties similar to water.

**Liquid temperature range** from 0 °C to +40 °C

**Maximum ambient temperature** +40°C

**Maximum operating pressure** PN12 (12bar)

**Special executions on request**  
contact our sales network

**Protection class** IP55

**The units comprise 1 x 18-litre expansion vessel for each pump and delivery and suction manifolds in AISI 304 stainless steel**



IE3 ≥ 0,75 kW

**D+CONNECT**

PAG. 5

MODEL	CODE	ELECTRICAL DATA			HYDRAULIC DATA		Ø		WEIGHT Kg
		VOLTAGE 50 Hz	P2 NOMINAL		Q m <sup>3</sup> /h	H m	DNA	DNM	
			kW	HP					
1KVC 75/50 M 230-50	60122105	1 X 230V ~	1,5	2	0,5-2,4-4,8	94-81-40	1"¼	1"½	33
1KVC 55/80 M 230-50	60122109	1 X 230V ~	1,5	2	0,7-4,8-9	76-61-23	1"¼	1"½	33
1KVC 65/80 T 400-50	60122111	3 X 400V ~	2,2	3	0,7-4,8-9	88-71-31	1"¼	1"½	34
1KVC 45/120 M 230-50	60179965	1 X 230V ~	1,85	2,5	1,2-6-12	62-52-17	1"¼	1"½	44
1KVC 70/120 T 400-50	60179966	3 X 400V ~	3	4	1,2-6-12	95-78-31	1"¼	1"½	38
1KVC 85/120 T 400-50	60179967	3 X 400V ~	3	4	1,2-6-12	112-90-34	1"¼	1"½	39

MODEL	CODE	ELECTRICAL DATA			HYDRAULIC DATA		Ø		WEIGHT Kg
		VOLTAGE 50 Hz	P2 NOMINAL		Q m <sup>3</sup> /h	H m	DNA	DNM	
			kW	HP					
2KVC 30/50 M 230-50	60122127	1 X 230V ~	0,55	0,75	0,5-4,8-9,6	41-35-17	2"	2"	70
2KVC 45/80 M 230-50	60122134	1 X 230V ~	1,1	1,5	0,7-9,6-18	65-53-21	2"	2"	82
2KVC 45/80 T 400-50	60122135	3 X 400V ~	1,1	1,5	0,7-9,6-18	65-53-21	2"	2"	82
2KVC 55/80 M 230-50	60122137	1 X 230V ~	1,5	2	0,7-9,6-18	76-61-23	2"	2"	84
2KVC 65/80 T 400-50	60179972	3 X 400V ~	2,2	3	0,7-9,6-18	88-71-31	2"	2"	85
2KVC 45/120 M 230-50	60179974	1 X 230V ~	1,85	2,5	1,2-12-24	62-52-17	2"	2"	86
2KVC 45/120 T 400-50	60179976	3 X 400V ~	1,85	2,5	1,2-12-24	62-52-17	2"	2"	86
2KVC 60/120 T 400-50	60179977	3 X 400V ~	2,2	3	1,2-12-24	78-63-25	2"	2"	90
2KVC 70/120 T 400-50	60179978	3 X 400V ~	3	4	1,2-12-24	95-78-31	2"	2"	94
2KVC 85/120 T 400-50	60179979	3 X 400V ~	3	4	1,2-12-24	112-90-34	2"	2"	95

MODEL	CODE	ELECTRICAL DATA			HYDRAULIC DATA		Ø		WEIGHT Kg
		VOLTAGE 50 Hz	P2 NOMINAL		Q m <sup>3</sup> /h	H m	DNA	DNM	
			kW	HP					
3KVC 45/80 T 400-50	60179981	3 X 400V ~	1,1	1,5	0,7-14,4-27	65-53-21	2"½	2"½	128
3KVC 65/80 T 400-50	60179982	3 X 400V ~	2,2	3	0,7-14,4-27	88-71-31	2"½	2"½	133
3KVC 45/120 T 400-50	60179983	3 X 400V ~	1,85	2,5	1,2-18-36	62-52-17	2"½	2"½	134
3KVC 60/120 T 400-50	60179984	3 X 400V ~	2,2	3	1,2-18-36	78-63-25	2"½	2"½	140
3KVC 70/120 T 400-50	60179985	3 X 400V ~	3	4	1,2-18-36	95-78-31	2"½	2"½	146
3KVC 85/120 T 400-50	60179986	3 X 400V ~	3	4	1,2-18-36	112-90-34	2"½	2"½	148

The units are supplied with tanks and air feeder connection.

# 1/2/3 KV 3-6-10

SETS WITH 1-2-3 VERTICAL MULTISTAGE PUMPS



1-2-3 KV are **fixed speed** pressurisation units with 1, 2 or 3 vertical axis multistage centrifugal pumps particularly suited for domestic use, and small civil, agricultural, or industrial systems for **applications with hot water up to 90°C**. The use of the electric panel (units with 2 and 3 pumps) guarantees automatic switching of the pumps, control at the main switch and protection of the electric pumps with thermal magnetic circuit breakers

The main features of the EBox panel with display for 2KV units are limited space requirements, sturdiness and absolute reliability.

Construction features – main components:

1 to 3 KV vertical axis multistage electric pumps

Tropicalized sheet steel base, complete with 4 anti-vibration rubber feet

Suction and delivery manifolds in galvanized steel

Control:

-1KVC --> the single-phase version has a 2-pole pressure switch with power input plug; while the three-phase version has a remote motor protector control panel with reset button.

-2KVC --> with EBox D panel with display.

-3KVC --> with E3G panel with pressure switches.

**Operating range** from 0.5 to 40 m<sup>3</sup>/h

**Pumped liquid** Clean, free of solids and abrasives, non-viscous, non-crystallised and chemically neutral, with properties similar to water

**Liquid temperature range** from -15 °C to +90 °C

**Maximum ambient temperature** +40°C

**Maximum operating pressure** PN16 (16bar)

**Special executions on request** contact our sales network

**Protection class** IP55

**Including 1 18-litre expansion vessel for each pump**



IE3 ≥ 0,75 kW

D+CONNECT PAG. 5

MODEL	CODE
1 KV3/10 M	500310100
1 KV3/12 M	500310120
1 KV6/9 T	60179993
1 KV6/11 T	60179995
1 KV10/8 T	60179997

VOLTAGE 50 Hz	ELECTRICAL DATA		HYDRAULIC DATA		Ø		WEIGHT Kg
	P2 NOMINAL		Q m <sup>3</sup> /h	H m	DNA	DNM	
	kW	HP					
1 X 230 V ~	1,1	1,5	1,8-7,2	73,5-15,5	1" ¼	1" ½	39
1 X 230 V ~	1,5	2	1,8-7,2	92-29	1" ¼	1" ½	40
3 X 400 V ~	1,5	2	2-8,5	74-22	1" ¼	1" ½	40
3 X 400 V ~	1,85	2,5	2-8,5	90-27	1" ¼	1" ½	38
3 X 400 V ~	2,2	3	3-13,5	73,5-28	1" ¼	1" ½	43

MODEL	CODE
2 KV6/9 M	500320292
2 KV10/5 M	500320452
2 KV3/15 T	60180000
2 KV6/7 T	60180002
2 KV6/9 T	60180003
2 KV6/11 T	60180004
2 KV6/15 T	60180005
2 KV10/6 T	60180006
2 KV10/8 T	60180007

VOLTAGE 50 Hz	ELECTRICAL DATA		HYDRAULIC DATA		Ø		WEIGHT Kg
	P2 NOMINAL		Q m <sup>3</sup> /h	H m	DNA	DNM	
	kW	HP					
1 X 230 V ~	1,5	2	4,8-17	74-22	2"	2"	108
1 X 230 V ~	1,5	2	6-26,4	46-17,5	2" ½	2" ½	108
3 X 400 V ~	1,85	2,5	3,6-14,4	115,5-36	2"	2"	110
3 X 400 V ~	1,1	1,5	4,8-17	55-17	2"	2"	100
3 X 400 V ~	1,5	2	4,8-17	74-22	2"	2"	102
3 X 400 V ~	1,85	2,5	4,8-17	90-27	2"	2"	108
3 X 400 V ~	2,2	3	4,8-17	123-37	2"	2"	128
3 X 400 V ~	1,85	2,5	6-26,4	55-21	2" ½	2" ½	108
3 X 400 V ~	2,2	3	6-26,4	73,5-28	2" ½	2" ½	114

MODEL	CODE
3 KV6/11 T	60180010
3 KV6/15 T	60180011
3 KV10/6 T	60180012
3 KV10/8 T	60180013

VOLTAGE 50 Hz	ELECTRICAL DATA		HYDRAULIC DATA		Ø		WEIGHT Kg
	P2 NOMINAL		Q m <sup>3</sup> /h	H m	DNA	DNM	
	kW	HP					
3 X 400 V ~	1,85	2,5	7,2-25,5	90-27	2" ½	2" ½	170
3 X 400 V ~	2,2	3	7,2-25,5	123-37	2" ½	2" ½	177
3 X 400 V ~	1,85	2,5	9-39,6	55-21	DN80	DN80	210
3 X 400 V ~	2,2	3	9-39,6	73,5-28	DN80	DN80	225

# 1/2/3/4 NKV

## FIXED SPEED PRESSURISATION UNITS



1-2-3-4 NKVE MCE are **variable speed** pressurisation units with 1, 2, 3 or 4 NKV vertical axis multistage centrifugal pumps in stainless steel, suitable for water systems of medium and large users. The use of vertical axis multistage centrifugal electric pumps ensures high performance results. **All the parts in contact with the liquid are rust-proof.**

Construction features – main components:

- 1 to 4 NKV vertical axis multistage electric pumps in stainless steel
- Suction and delivery manifolds in AISI 304 stainless steel
- Delivery and suction on-off valves for each pump
- Check valves on the delivery ports of each pump
- 1 electric control panel with direct start up to 7.5 kW included, star-triangle start for higher voltages. AUT-0-MAN operation selectors and operation notification lamps on the front of the panel
- 1 18-litre expansion vessel for each pump
- 1 pressure transmitter for each pump

**The units are provided already assembled, set up and tested directly at the factory, and with the installation and maintenance instructions and test report.**

**Operating range** from 0.5 to 280 m<sup>3</sup>/h  
**Pumped liquid** clean, free of solids and abrasives, non-viscous, non-aggressive, non-crystallised and chemically neutral, with properties similar to water.  
**Liquid temperature range** from 0°C to +120°C (80°C with expansion vessel installed)  
**Maximum ambient temperature** +50°C  
**Maximum operating pressure** PN16 (up to PN25 on request)  
**Protection class** IP55 (IP55 motors on request)  
**Special executions on request** voltages and/or frequencies not on the general catalogue, available on request  
**Version "X", components in contact with the water made in AISI 316 stainless steel**

The units comprise 1 x 18-litre expansion vessel for each pump and delivery and suction manifolds in AISI 304 stainless steel



IE3 ≥ 0,75 kW

MODEL	CODE
1NKV 10/5 S T	60180242
1NKV 10/6 S T	60180243
1NKV 10/7 S T	60180244
1NKV 10/8 S T	60180245
1NKV 10/9 S T	60180249
1NKV 10/10 S T	60180250
1NKV 10/12 S T	60180251
1NKV 10/15 S T	60180252
1NKV 15/3 S T	60180253
1NKV 15/4 S T	60180254
1NKV 15/5 S T	60180255
1NKV 15/6 S T	60180256
1NKV 15/7 S T	60180257
1NKV 15/8 S T	60180258
1NKV 15/9 S T	60180259
1NKV 15/10 S T	60180260
1NKV 20/3 S T	60180261
1NKV 20/4 S T	60180262
1NKV 20/5 S T	60180263
1NKV 20/6 S T	60180264
1NKV 20/7 S T	60180265
1NKV 20/8 S T	60180266
1NKV 20/9 S T	60180267
1NKV 20/10 S T	60180268
1NKV 32/2-2 T	60180269
1NKV 32/2 T	60180270
1NKV 32/3-2 T	60180271
1NKV 32/3 T	60180272
1NKV 32/4-2 T	60180273
1NKV 32/4 T	60180274
1NKV 32/5-2 T	60180275
1NKV 32/5 T	60180276
1NKV 32/6-2 T	60180277
1NKV 32/6 T	60180278
1NKV 45/2-2 T	60180279
1NKV 45/2 T	60180280
1NKV 45/3-2 T	60180281
1NKV 45/3 T	60180282
1NKV 45/4-2 T	60180283
1NKV 45/4 T	60180284
1NKV 45/5-2 T	60180285
1NKV 45/5 T	60180286
1NKV 45/6-2 T	60180287
1NKV 45/6 T	60180288

MODEL	CODE
2NKV 10/5 S T	60180265
2NKV 10/6 S T	60180266
2NKV 10/7 S T	60180267
2NKV 10/8 S T	60180268
2NKV 10/9 S T	60180269
2NKV 10/10 S T	60180270
2NKV 10/12 S T	60180271
2NKV 10/15 S T	60180272
2NKV 15/3 S T	60180273
2NKV 15/4 S T	60180274
2NKV 15/5 S T	60180275
2NKV 15/6 S T	60180276
2NKV 15/7 S T	60180277
2NKV 15/8 S T	60180278
2NKV 15/9 S T	60180279
2NKV 15/10 S T	60180280
2NKV 20/3 S T	60180281
2NKV 20/4 S T	60180282
2NKV 20/5 S T	60180283
2NKV 20/6 S T	60180284
2NKV 20/7 S T	60180285
2NKV 20/8 S T	60180286
2NKV 20/9 S T	60180287
2NKV 20/10 S T	60180288
2NKV 32/2-2 T	60180289
2NKV 32/2 T	60180290
2NKV 32/3-2 T	60180291
2NKV 32/3 T	60180292
2NKV 32/4-2 T	60180293
2NKV 32/4 T	60180294
2NKV 32/5-2 T	60180295
2NKV 32/5 T	60180296
2NKV 32/6-2 T	60180297
2NKV 32/6 T	60180298
2NKV 45/2-2 T	60180299
2NKV 45/2 T	60180300
2NKV 45/3-2 T	60180301
2NKV 45/3 T	60180302
2NKV 45/4-2 T	60180303
2NKV 45/4 T	60180304
2NKV 45/5-2 T	60180305
2NKV 45/5 T	60180306
2NKV 45/6-2 T	60180307
2NKV 45/6 T	60180308

MODEL	CODE
3NKV 10/5 S T	60180285
3NKV 10/6 S T	60180286
3NKV 10/7 S T	60180287
3NKV 10/8 S T	60180288
3NKV 10/9 S T	60180289
3NKV 10/10 S T	60180290
3NKV 10/12 S T	60180291
3NKV 10/15 S T	60180292
3NKV 15/3 S T	60180293
3NKV 15/4 S T	60180294
3NKV 15/5 S T	60180295
3NKV 15/6 S T	60180296
3NKV 15/7 S T	60180297
3NKV 15/8 S T	60180298
3NKV 15/9 S T	60180299
3NKV 15/10 S T	60180300
3NKV 20/3 S T	60180301
3NKV 20/4 S T	60180302
3NKV 20/5 S T	60180303
3NKV 20/6 S T	60180304
3NKV 20/7 S T	60180305
3NKV 20/8 S T	60180306
3NKV 20/9 S T	60180307
3NKV 20/10 S T	60180308
3NKV 32/2-2 T	60180309
3NKV 32/2 T	60180310
3NKV 32/3-2 T	60180311
3NKV 32/3 T	60180312
3NKV 32/4-2 T	60180313
3NKV 32/4 T	60180314
3NKV 32/5-2 T	60180315
3NKV 32/5 T	60180316
3NKV 32/6-2 T	60180317
3NKV 32/6 T	60180318
3NKV 45/2-2 T	60180319
3NKV 45/2 T	60180320
3NKV 45/3-2 T	60180321
3NKV 45/3 T	60180322
3NKV 45/4-2 T	60180323
3NKV 45/4 T	60180324
3NKV 45/5-2 T	60180325
3NKV 45/5 T	60180326
3NKV 45/6-2 T	60180327
3NKV 45/6 T	60180328

MODEL	CODE
4NKV 10/5 S T	60180306
4NKV 10/6 S T	60180307
4NKV 10/7 S T	60180309
4NKV 10/8 S T	60180311
4NKV 10/9 S T	60180314
4NKV 10/10 S T	60180315
4NKV 10/12 S T	60180316
4NKV 15/3 S T	60180317
4NKV 15/4 S T	60180318
4NKV 15/5 S T	60180319
4NKV 15/6 S T	60180320
4NKV 15/7 S T	60180322
4NKV 15/8 S T	60180323
4NKV 15/9 S T	60180324
4NKV 15/10 S T	60180325
4NKV 20/3 S T	60180326
4NKV 20/4 S T	60180327
4NKV 20/5 S T	60180328
4NKV 20/6 S T	60180329
4NKV 20/7 S T	60180330
4NKV 20/8 S T	60180331
4NKV 20/9 S T	60180332
4NKV 20/10 S T	60180333
4NKV 32/2-2 T	60180334
4NKV 32/2 T	60180335
4NKV 32/3-2 T	60180336
4NKV 32/3 T	60180337
4NKV 32/4-2 T	60180338
4NKV 32/4 T	60180339
4NKV 32/5-2 T	60180340
4NKV 32/5 T	60180341
4NKV 32/6-2 T	60180342
4NKV 32/6 T	60180343
4NKV 45/2-2 T	60180344
4NKV 45/2 T	60180345
4NKV 45/3-2 T	60180346
4NKV 45/3 T	60180347
4NKV 45/4-2 T	60180348
4NKV 45/4 T	60180349
4NKV 45/5-2 T	60180350
4NKV 45/5 T	60180351
4NKV 45/6-2 T	60180352
4NKV 45/6 T	60180353

# 2 NKV 10/15/20 WITH EBOX

PRESSURIZATION GROUPS WITH 2 MULTISTAGE CENTRIFUGAL PUMPS WITH A VERTICAL AXIS



### Construction features - Groups with 2 pumps

- Groups consisting of N. 2 main electric pumps centrifugal multistage on a vertical axis NKV.
- Impellers in stainless steel AISI 304, all parts in contact with liquid are stainless
- Three phase asynchronous motor, motor-pump by means of a rigid coupling.
- Pumps mounted on a single base in galvanized steel.

### HYDRAULIC GROUP

Intake Manifold Inox, Stainless steel manifold, pressure transducer, electrical control panel, n. 2 expansion tanks, each suction pump with inlet shutoff valves, each pump with outlet shutoff and check valves.

### ELECTRICAL CONTROL PANEL

E-box IP 54 switchboard mounted on the crankcase pumps. Direct start up to 5.5 kw including, front panel switches for AUT-O-MAN operation, warning lights.

**Line voltage** 400V three phase.

**Voltage of electric pump** 400V three phase.

**Power frequency** 50-60 Hz.

**Installation** vertical only.

**Operating range** from 4 to 280 m<sup>3</sup>/h

**Pumped liquid temperature range** from 0°C to +120°C (80°C with expansion vessel installed)

**Maximum ambient temperature** 50°C

**Max pressure** 16bar

**Pumped liquid** clean, free of solids

**Pressure control range** from 3 to 14 bar

**Protection class** IP55

**The units comprise 1 x 18-litre expansion vessel for each pump and delivery and suction manifolds in AISI 304 stainless steel**



IE3 ≥ 0,75 kW

**D+CONNECT**

PAG. 5

MODEL	CODE	ELECTRICAL DATA			Ø		WEIGHT Kg
		VOLTAGE	P2 NOMINAL		DNA	DNM	
			KW	HP			
2NKV 10/5 T S EBOX 400/50	60180333	3 x 400 50Hz	2x1,5	2x2	2" 1/2	2" 1/2	238
2NKV 10/6 T S EBOX 400/50	60180334	3 x 400 50Hz	2x2,2	2x3	2" 1/2	2" 1/2	239
2NKV 10/7 T S EBOX 400/50	60180335	3 x 400 50Hz	2x2,2	2x3	2" 1/2	2" 1/2	259
2NKV 10/8 T S EBOX 400/50	60180336	3 x 400 50Hz	2x3	2x4	2" 1/2	2" 1/2	261
2NKV 10/9 T S EBOX 400/50	60180337	3 x 400 50Hz	2x3	2x4	2" 1/2	2" 1/2	263
2NKV 10/10 T S EBOX 400/50	60180338	3 x 400 50Hz	2x4	2x5,5	2" 1/2	2" 1/2	282
2NKV 10/12 T S EBOX 400/50	60180339	3 x 400 50Hz	2x4	2x5,5	2" 1/2	2" 1/2	286
2NKV 10/15 T S EBOX 400/50	60180340	3 x 400 50Hz	2x5,5	2x7,5	2" 1/2	2" 1/2	342
2NKV 15/3 T S EBOX 400/50	60180341	3 x 400 50Hz	2x3	2x4	100	80	276
2NKV 15/4 T S EBOX 400/50	60180342	3 x 400 50Hz	2x4	2x5,5	100	80	280
2NKV 15/5 T S EBOX 400/50	60180343	3 x 400 50Hz	2x4	2x5,5	100	80	285
2NKV 15/6 T S EBOX 400/50	60180344	3 x 400 50Hz	2x5,5	2x7,5	100	80	374
2NKV 15/7 T S EBOX 400/50	60180345	3 x 400 50Hz	2x5,5	2x7,5	100	80	377
2NKV 20/3 T S EBOX 400/50	60180346	3 x 400 50Hz	2x3	2x4	100	80	284
2NKV 20/4 T S EBOX 400/50	60180348	3 x 400 50Hz	2x4	2x5,5	100	80	364
2NKV 20/5 T S EBOX 400/50	60180349	3 x 400 50Hz	2x5,5	2x7,5	100	80	366

# 1/2/3 NKP-G / K

SETS WITH CENTRIFUGAL PUMPS K - NKP-G



Water lifting sets suitable for civilian installation, condominiums, hotels, tourist facilities and industrial uses.

Lifting units equipped with 1-2-3 centrifugal pumps K series (twin impeller) and NKP / NKP-G series. All lifting are complete with galvanised steel base, suction and delivery manifold (for units with one pump only delivery manifold), one stop valve on suction side for each pump and stop valve and non return valve on delivery side for each pump.

1 - 2 or 3 20 liters membran tanks; pressure trasmitter (pressure switch for 2-3 K 55/200) and pressure gauge on delivery manifold.

Electrical panel: IP 55, direct starting for single motors inputs up to 7,5 kW (included) and star-delta starting for single motors from 9,2 kW.

- Weekly test included as standard for all units.
- Available, where indicated, also with the relative pilot pump KVCX series.
- The units is supplied assembled, tested, in a strong cardboard box with wooden pallet and instructions sheet with electrical diagram.

### Weekly test included

**Line voltage** 400V three phase.

**Voltage of electric pump** 400V three phase.

**Power frequency** 50-60 Hz.

**Installation** vertical only.

**Operating range** from 4 to 720 m<sup>3</sup>/h.

**Pumped liquid temperature range**

from -15 °C to + 70 °C

(max 40 °C for the version with jockey pump).

**Maximum ambient temperature** 40°C.

**Max pressure** 10bar.

**Pumped liquid** clean, free of solids.

**Protection class** IP55

IE3 ≥ 0,75 kW

## 1 K - 1NKP-G

### 1 CENTRIFUGAL PUMP

MODEL	CODE
1K 70/300 400-50	60180350
1K 80/300 400-50	60169853
1K 70/400 400-50	60169854
1K 80/400 400-50	60169855
1NKP-G 32-160/151 3 400-50	60180351
1NKP-G 32-160/163 4 400-50	60180352
1NKP-G 32-200/190 5,5 400-50	60180353
1NKP-G 32-200/210 7,5 400-50	60169856
1NKP-G 40-160/158 5,5 400-50	60180354
1NKP-G 40-160/172 7,5 400-50	60169857
1NKP-G 40-200/210 11 400-50	60169858
1NKP-G 40-250/230 15 400-50	60169859
1NKP-G 40-250/245 18,5 400-50	60169860
1NKP-G 40-250/260 22 400-50	60169861
1NKP-G 50-160/153 7,5 400-50	60169862
1NKP-G 50-160/169 11 400-50	60169863
1NKP-G 50-200/200 15 400-50	60169864
1NKP-G 50-200/210 18,5 400-50	60169865
1NKP-G 50-200/219 22 400-50	60169866
1NKP-G 50-250/230 22 400-50	60169867
1NKP-G 50-250/257 30 400-50	60169868
1NKP-G 65-160/157 11 400-50	60169869
1NKP-G 65-160/173 15 400-50	60169870
1NKP-G 65-200/190 18,5 400-50	60169871
1NKP-G 65-200/200 22 400-50	60169872
1NKP-G 65-200/219 30 400-50	60169873
1NKP-G 80-160/153 15 400-50	60169874
1NKP-G 80-160/163 18,5 400-50	60169875
1NKP-G 80-160/169 22 400-50	60169876
1NKP-G 80-200/190 30 400-50	60169878

### 1 CENTRIFUGAL PUMP + PILOT PUMP KVCX

MODEL	CODE
1K 70/300-KVCX 65-50 400-50	60180355
1K 80/300-KVCX 65-50 400-50	60169879
1K 70/400-KVCX 65-80 400-50	60169880
1K 80/400-KVCX 65-80 400-50	60169881
1NKP-G 32-160/151 3-KVCX 65-50 400-50	60180356
1NKP-G 32-160/163 4-KVCX 65-50 400-50	60180357
1NKP-G 32-200/190 5,5-KVCX 65-50 400-50	60180358
1NKP-G 32-200/210 7,5-KVCX 65-50 400-50	60169882
1NKP-G 40-160/158 5,5-KVCX 65-50 400-50	60180359
1NKP-G 40-160/172 7,5-KVCX 65-50 400-50	60169883
1NKP-G 40-200/210 11-KVCX 65-80 400-50	60169884
1NKP-G 40-250/230 15-KVCX 65-80 400-50	60169885
1NKP-G 40-250/245 18,5-KVCX 65-80 400-50	60169886
1NKP-G 40-250/260 22-KVCX 65-80 400-50	60169887
1NKP-G 50-160/153 7,5-KVCX 65-50 400-50	60169888
1NKP-G 50-160/169 11-KVCX 65-80 400-50	60169889
1NKP-G 50-200/200 15-KVCX 65-80 400-50	60169890
1NKP-G 50-200/210 18,5-KVCX 65-80 400-50	60169891
1NKP-G 50-200/219 22-KVCX 65-80 400-50	60169892
1NKP-G 50-250/230 22-KVCX 65-80 400-50	60169894
1NKP-G 50-250/257 30-KVCX 65-80 400-50	60169895
1NKP-G 65-160/157 11-KVCX 65-80 400-50	60169896
1NKP-G 65-160/173 15-KVCX 65-80 400-50	60169897
1NKP-G 65-200/190 18,5-KVCX 65-80 400-50	60169898
1NKP-G 65-200/200 22-KVCX 65-80 400-50	60169899
1NKP-G 65-200/219 30-KVCX 65-80 400-50	60169901
1NKP-G 80-160/153 15-KVCX 65-80 400-50	60169902
1NKP-G 80-160/163 18,5-KVCX 65-80 400-50	60169903
1NKP-G 80-160/169 22-KVCX 65-80 400-50	60169904
1NKP-G 80-200/190 30-KVCX 65-80 400-50	60169905



# 1/2/3 NKP-G / K

SETS WITH CENTRIFUGAL PUMPS K - NKP-G



## 2K - 2NKP-G

### 2 CENTRIFUGAL PUMP

MODEL	CODE
2 K55/200 T	60180360
2 K55/200 T + PS	60180361
2K 70/300 400-50	60180362
2K 80/300 400-50	60169906
2K 70/400 400-50	60169907
2K 80/400 400-50	60169908
2NKP-G 32-160/151 3 400-50	60180363
2NKP-G 32-160/163 4 400-50	60180364
2NKP-G 32-200/190 5,5 400-50	60180365
2NKP-G 32-200/210 7,5 400-50	60169909
2NKP-G 40-160/158 5,5 400-50	60180366
2NKP-G 40-160/172 7,5 400-50	60169910
2NKP-G 40-200/210 11 400-50	60169911
2NKP-G 40-250/230 15 400-50	60169913
2NKP-G 40-250/245 18,5 400-50	60169914
2NKP-G 40-250/260 22 400-50	60169915
2NKP-G 50-160/153 7,5 400-50	60169916
2NKP-G 50-160/169 11 400-50	60169917
2NKP-G 50-200/200 15 400-50	60169918
2NKP-G 50-200/210 18,5 400-50	60169919
2NKP-G 50-200/219 22 400-50	60169920
2NKP-G 50-250/230 22 400-50	60169921
2NKP-G 50-250/257 30 400-50	60169922
2NKP-G 65-160/157 11 400-50	60169923
2NKP-G 65-160/173 15 400-50	60169924
2NKP-G 65-200/190 18,5 400-50	60169925
2NKP-G 65-200/200 22 400-50	60169926
2NKP-G 65-200/219 30 400-50	60169927
2NKP-G 80-160/153 15 400-50	60169928
2NKP-G 80-160/163 18,5 400-50	60169929
2NKP-G 80-160/169 22 400-50	60169930
2NKP-G 80-200/190 30 400-50	60169931

### 2 CENTRIFUGAL PUMP + PILOT PUMP KVCX

MODEL	CODE
2 K55/200 T (JOCKEY PUMP KV 6/7 T)	60180367
2 K55/200 T (JOCKEY PUMP KV 6/7 T) + PS	60180368
2K 70/300-KVCX 65-50 400-50	60180369
2K 80/300-KVCX 65-50 400-50	60169932
2K 70/400-KVCX 65-80 400-50	60169933
2K 80/400-KVCX 65-80 400-50	60169934
2NKP-G 32-160/151 3-KVCX 65-50 400-50	60180370
2NKP-G 32-160/163 4-KVCX 65-50 400-50	60180371
2NKP-G 32-200/190 5,5-KVCX 65-50 400-50	60180372
2NKP-G 32-200/210 7,5-KVCX 65-50 400-50	60169935
2NKP-G 40-160/158 5,5-KVCX 65-50 400-50	60180373
2NKP-G 40-160/172 7,5-KVCX 65-50 400-50	60169936
2NKP-G 40-200/210 11-KVCX 65-80 400-50	60169937
2NKP-G 40-250/230 15-KVCX 65-80 400-50	60169938
2NKP-G 40-250/245 18,5-KVCX 65-80 400-50	60169939
2NKP-G 40-250/260 22-KVCX 65-80 400-50	60169940
2NKP-G 50-160/153 7,5-KVCX 65-50 400-50	60169941
2NKP-G 50-160/169 11-KVCX 65-80 400-50	60169942
2NKP-G 50-200/200 15-KVCX 65-80 400-50	60169943
2NKP-G 50-200/210 18,5-KVCX 65-80 400-50	60169944
2NKP-G 50-200/219 22-KVCX 65-80 400-50	60169945
2NKP-G 50-250/230 22-KVCX 65-80 400-50	60169946
2NKP-G 50-250/257 30-KVCX 65-80 400-50	60169947
2NKP-G 65-160/157 11-KVCX 65-80 400-50	60169948
2NKP-G 65-160/173 15-KVCX 65-80 400-50	60169949
2NKP-G 65-200/190 18,5-KVCX 65-80 400-50	60169950
2NKP-G 65-200/200 22-KVCX 65-80 400-50	60169951
2NKP-G 65-200/219 30-KVCX 65-80 400-50	60169952
2NKP-G 80-160/153 15-KVCX 65-80 400-50	60169953
2NKP-G 80-160/163 18,5-KVCX 65-80 400-50	60169954
2NKP-G 80-160/169 22-KVCX 65-80 400-50	60169955
2NKP-G 80-200/190 30-KVCX 65-80 400-50	60169956

# 1/2/3 NKP-G / K

SETS WITH CENTRIFUGAL PUMPS K - NKP-G



## 3 K - 3 NKP-G

### 3 CENTRIFUGAL PUMP

MODEL	CODE
3 K55/200 T	60180374
3 K55/200 T + PS	60180375
3K 70/300 400-50	60180376
3K 80/300 400-50	60169957
3K 70/400 400-50	60169958
3K 80/400 400-50	60169959
3NKP-G 32-160/151 3 400-50	60180377
3NKP-G 32-160/163 4 400-50	60180378
3NKP-G 32-200/190 5,5 400-50	60180379
3NKP-G 32-200/210 7,5 400-50	60169960
3NKP-G 40-160/158 5,5 400-50	60180380
3NKP-G 40-160/172 7,5 400-50	60169961
3NKP-G 40-200/210 11 400-50	60169962
3NKP-G 40-250/230 15 400-50	60169963
3NKP-G 40-250/245 18,5 400-50	60169964
3NKP-G 40-250/260 22 400-50	60169965
3NKP-G 50-160/153 7,5 400-50	60169966
3NKP-G 50-160/169 11 400-50	60169967
3NKP-G 50-200/200 15 400-50	60169968
3NKP-G 50-200/210 18,5 400-50	60169969
3NKP-G 50-200/219 22 400-50	60169970
3NKP-G 50-250/230 22 400-50	60169972
3NKP-G 50-250/257 30 400-50	60169975
3NKP-G 65-160/157 11 400-50	60169985
3NKP-G 65-160/173 15 400-50	60169987
3NKP-G 65-200/190 18,5 400-50	60169988
3NKP-G 65-200/200 22 400-50	60169989
3NKP-G 65-200/219 30 400-50	60169990
3NKP-G 80-160/153 15 400-50	60169991
3NKP-G 80-160/163 18,5 400-50	60169992
3NKP-G 80-160/169 22 400-50	60169993
3NKP-G 80-200/190 30 400-50	60169994

### 3 CENTRIFUGAL PUMP + PILOT PUMP KVCX

MODEL	CODE
3 K55/200 T (JOCKEY PUMP KV 6/7 T)	60180383
3 K55/200 T (JOCKEY PUMP KV 6/7 T) + PS	60180384
3K 70/300-KVCX 65-50 400-50	60180385
3K 80/300-KVCX 65-50 400-50	60169995
3K 70/400-KVCX 65-80 400-50	60169996
3K 80/400-KVCX 65-80 400-50	60169997
3NKP-G 32-160/151 3-KVCX 65-50 400-50	60180386
3NKP-G 32-160/163 4-KVCX 65-50 400-50	60180387
3NKP-G 32-200/190 5,5 -KVCX 65-50 400-50	60180388
3NKP-G 32-200/210 7,5-KVCX 65-50 400-50	60169999
3NKP-G 40-160/158 5,5-KVCX 65-50 400-50	60180389
3NKP-G 40-160/172 7,5-KVCX 65-50 400-50	60170000
3NKP-G 40-200/210 11-KVCX 65-80 400-50	60170002
3NKP-G 40-250/230 15-KVCX 65-80 400-50	60170004
3NKP-G 40-250/245 18,5-KVCX 65-80 400-50	60170008
3NKP-G 40-250/260 22-KVCX 65-80 400-50	60170011
3NKP-G 50-160/153 7,5-KVCX 65-50 400-50	60170014
3NKP-G 50-160/169 11-KVCX 65-80 400-50	60170016
3NKP-G 50-200/200 15-KVCX 65-80 400-50	60170018
3NKP-G 50-200/210 18,5-KVCX 65-80 400-50	60170020
3NKP-G 50-200/219 22-KVCX 65-80 400-50	60170022
3NKP-G 50-250/230 22-KVCX 65-80 400-50	60170026
3NKP-G 50-250/257 30-KVCX 65-80 400-50	60170029
3NKP-G 65-160/157 11-KVCX 65-80 400-50	60170031
3NKP-G 65-160/173 15-KVCX 65-80 400-50	60170034
3NKP-G 65-200/190 18,5-KVCX 65-80 400-50	60170036
3NKP-G 65-200/200 22-KVCX 65-80 400-50	60170038
3NKP-G 65-200/219 30-KVCX 65-80 400-50	60170040
3NKP-G 80-160/153 15-KVCX 65-80 400-50	60170043
3NKP-G 80-160/163 18,5-KVCX 65-80 400-50	60170044
3NKP-G 80-160/169 22-KVCX 65-80 400-50	60170045
3NKP-G 80-200/190 30-KVCX 65-80 400-50	60170048

# 1 KDN COMPACT

FIRE - FIGHTING BOOSTER SETS UNI EN12845 WITH ELECTRIC PUMP AND DIESEL PUMP



Diesel and electric motor fire-fighting sets, ideal for automatic sprinkler systems and/or hydrants of commercial buildings. Designed to be coupled with each other, in order to obtain all the versions and meet all the requirements of the EN 12845 and UNI 10779 standards.

The pump is coupled, by means of a spacer elastic coupling, to an electric motor or Diesel engine capable of providing the power absorbed by the pump at any pump load condition, from no-load, to a load corresponding to NPSH16m (as requested by section 10.1 of the UNI EN 12845 standard).

#### Modular design:

The UNI EN 12845 DAB fire-fighting sets are supplied in modular version. This setup facilitates transport, and the installation of DAB fire-fighting pump sets in pump rooms, even with narrow access doors. Thanks to a coupling kit (supplied as accessory), it is possible to obtain all the compositions contemplated by the standard (one, two, or three electric or Diesel pumps, with or without jockey pump).

**Operating range** from 10 to 650 m<sup>3</sup>/h

**Pumped liquid** clean, free of solids and abrasives, non-viscous, non-aggressive, non-crystallised and chemically neutral, with properties similar to water.

**Liquid temperature range** from 0 to 70°C

**Maximum ambient temperature** + 40°C

**Maximum operating pressure** 16 bar (1600kPa) PN16

**Special executions on request** diesel version with water/water heat exchanger, 230 three-phase 50 or 60 Hz electric versions, bronze impeller

UNI EN 12845



ISTITUTO  
GIORDANO  
Qualità al Plurale

ACCESSORIES  
PAG. 367

## FEATURES



#### COLLECTION RESERVOIR

Reservoir for the collection of any fuel leaking out of the diesel tank, included up to 11kW pursuant to standard UNI 11292.



#### TANK

All the engine-drive pumps have a fuel pump sized to ensure 6 hours of operation, as required for the highest hazard classes pursuant to standard EN12845 - 10.9.6.



#### CLAPET VALVE

An inspectionable check valve is mounted on the delivery port of each main pump to facilitate maintenance.



#### FRAME

Compact steel frame painted RAL 3000 red to support the pump, with anti-vibration devices to dampen the vibrations transmitted to the system.



#### CONTROL PANELS

All the fire-fighting sets have an electric control panel pursuant to EN 12845 /UNI 10779 for each main pump and an electric control panel for the jockey pump, already connected to the main components (motor, pressure switches, sensor, batteries, etc.).

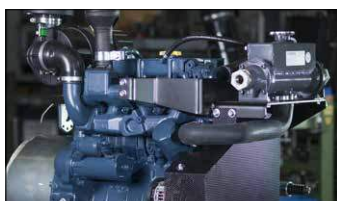

#### MOTORS

The motors of all the main pumps are sized in accordance with standard EN 12845 - 10.1 to supply the power absorbed by the pump under any load conditions up to an NPSH value of 16 m.c.w.



#### ALARM REMOTE CONTROL UNIT

Alarm notification and remote control unit suitable for sets with 1 to 3 pumps. The GSM module accessory makes it possible to receive notification text messages in real time on the status of the pumping system.

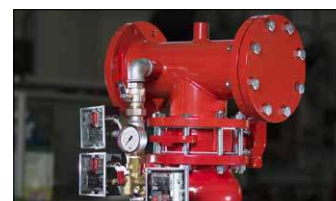

#### HIGH QUALITY

Fire-fighting sets designed and manufactured with components that guarantee a high standard of quality.

# 1 KDN COMPACT

FIRE -FIGHTING BOOSTER SETS UNI EN12845 WITH ELECTRIC PUMP AND DIESEL PUMP



## PERFORMANCE OF THE 1KDN

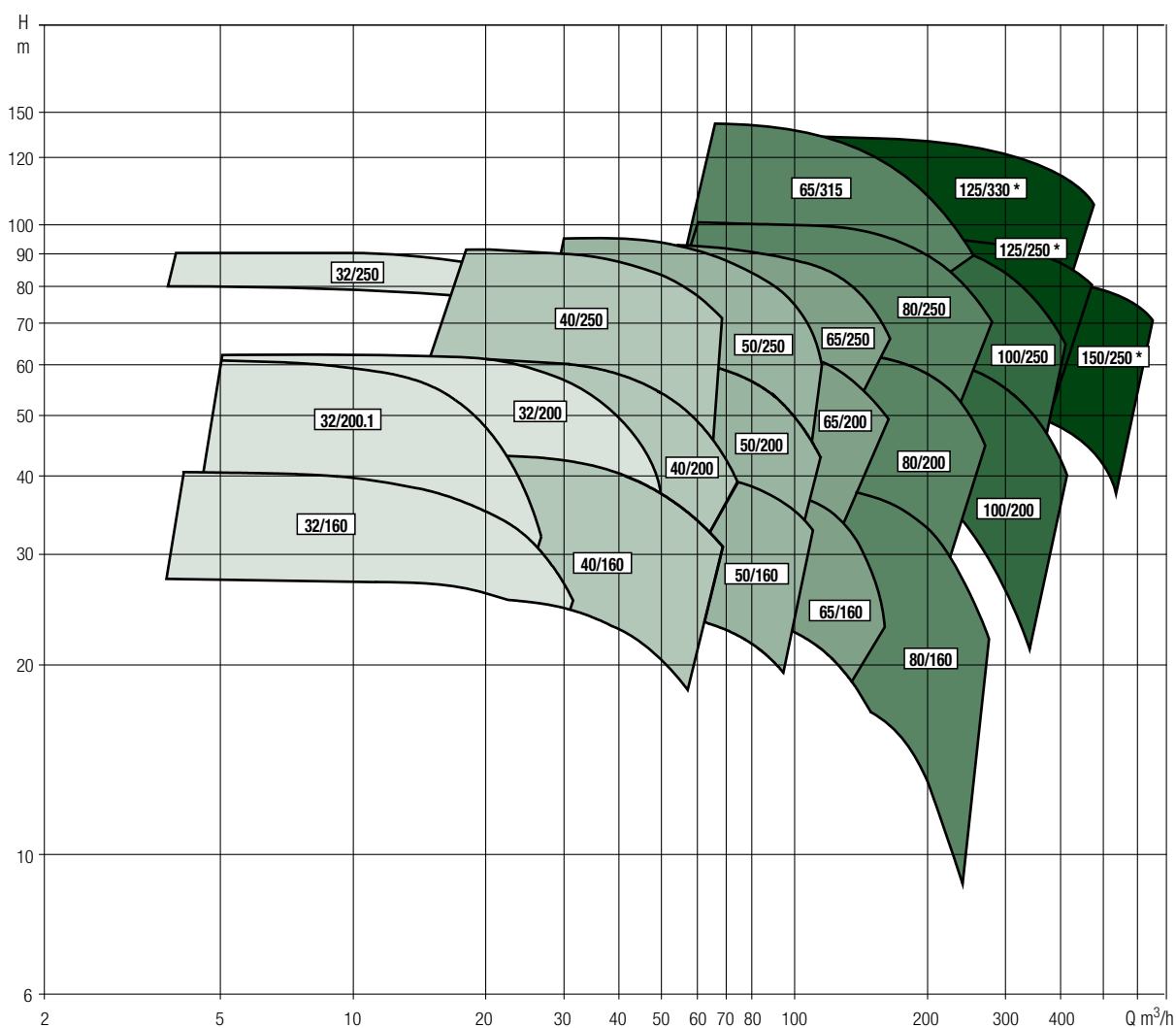

\* Oversize versions of the KDN: 125-250 / 125-330 / 150-250

RANGE OF OVERSIZE VERSIONS OF THE KDN	RANGE OF STANDARD VERSIONS OF THE KDN
FLOW: UP TO 650 m <sup>3</sup> /h	FLOW: UP TO 400 m <sup>3</sup> /h
HEAD: UP TO 130 m.	HEAD: UP TO 120 m.

# 1 KDN COMPACT

FIRE - FIGHTING BOOSTER SETS UNI EN12845 WITH ELECTRIC PUMP AND DIESEL PUMP



## TECHNICAL DATA - 1 KDN PUMPS

### 1 KDN

MODEL	CODE	P2 (kW)
1KDN 32-160.1/161 3 T 400/50 EN12845 COMPACT	60174386	3,0
1KDN 32-160.1/169 4 T 400/50 EN12845 COMPACT	60174387	4,0
1KDN 32-160.1/177 5,5 T 400/50 EN12845 COMPACT	60174388	5,5
1KDN 32-160/177 5,5 T400/50 EN12845 COMPACT	60174389	5,5
1KDN 32-200.1/190 5,5 T 400/50 EN12845 COMPACT	60174390	5,5
1KDN 32-200.1/200 5,5 T 400/50 EN12845 COMPACT	60174391	5,5
1KDN 32-200.1/207 7,5 T 400/50 EN12845 COMPACT	60174392	7,5
1KDN 32-200/180 5,5 T 400/50 EN 12845 COMPACT	60174393	5,5
1KDN 32-200/190 7,5 T 400/50 EN12845 COMPACT	60174394	7,5
1KDN 32-200/200 7,5 T 400/50 EN12845 COMPACT	60174395	7,5
1KDN 32-200/210 11 T 400/50 EN12845 COMPACT	60174396	11,0
1KDN 32-200/219 11 T 400/50 EN12845 COMPACT	60174397	11,0
1KDN 32-250/257 15 T400/50 EN 12845 COMPACT	60176404	15,0
1KDN 40-160/161 7,5 T400/50 EN 12845 COMPACT	60174398	7,5
1KDN 40-160/177 11 T400/50 EN 12845 COMPACT	60174399	11,0
1KDN 40-200/200 11 T400/50 EN 12845 COMPACT	60174400	11,0
1KDN 40-200/219 15 T400/50 EN 12845 COMPACT	60176405	15,0
1KDN 40-250/230 15 T400/50 EN 12845 COMPACT	60176406	15,0
1KDN 40-250/240 18,5 T400/50 EN 12845 COMPACT	60176407	18,5
1KDN 40-250/260 30 T400/50 EN 12845 COMPACT	60176408	30,0
1KDN 50-160/161 11 T400/50 EN 12845 COMPACT	60176409	11,0
1KDN 50-160/177 15 T400/50 EN 12845 COMPACT	60176410	15,0
1KDN 50-200/190 15 T400/50 EN 12845 COMPACT	60176411	15,0
1KDN 50-200/210 18,5 T400/50 EN 12845 COMPACT	60176412	18,5
1KDN 50-200/219 22 T400/50 EN 12845 COMPACT	60176413	22,0
1KDN 50-250/230 22 T400/50 EN 12845 COMPACT	60176414	22,0
1KDN 50-250/250 30 T400/50 EN 12845 COMPACT	60176415	30,0
1KDN 50-250/263 37 T400/50 EN 12845 COMPACT	60176416	37,0
1KDN 65-160/153 11 T400/50 EN 12845 COMPACT	60176417	11,0
1KDN 65-200/190 18,5 T400/50 EN 12845 COMPACT	60176418	18,5
1KDN 65-200/200 22 T400/50 EN 12845 COMPACT	60176419	22,0
1KDN 65-250/230 30 T400/50 EN 12845 COMPACT	60176420	30,0
1KDN 65-250/250 37 T400/50 EN 12845 COMPACT	60176421	37,0
1KDN 65-250/263 45 T400/50 EN 12845 COMPACT	60176422	45,0
1KDN 65-315/275 55 T400/50 EN12845 COMPACT	60176423	55,0
1KDN 65-315/290 75 T400/50 EN12845 COMPACT	60176424	75,0
1KDN 65-315/305 90 T400/50 EN12845 COMPACT	60176425	90,0
1KDN 65-315/320 110 T400/50 EN12845 COMPACT	60176426	110,0
1KDN 80-160/177 30 T400/50 EN 12845 COMPACT	60176427	30,0
1KDN 80-200/200 37 T400/50 EN 12845 COMPACT	60176428	37,0
1KDN 80-250/240 55 T400/50 EN 12845 COMPACT	60176429	55,0
1KDN 80-250/260 75 T400/50 EN 12845 COMPACT	60176430	75,0
1KDN 80-250/270 90 T400/50 EN 12845 COMPACT	60176431	90,0
1KDN 80-315/290 110 T400/50 IE3 EN12845 COMPACT	60187462	110,0
1KDN 100-200/200 55 T400/50 EN 12845 COMPACT	60176432	55,0
1KDN 100-200/219 75 T400/50 EN 12845 COMPACT	60176433	75,0
1KDN 100-250/240 90 T400/50 EN 12845 COMPACT	60176434	90,0
1KDN 100-250/260 110 T400/50 EN 12845 COMPACT	60176435	110,0
1KDN 125-250/264 160 T400/50 IE3 EN12845 COMPACT	60189108	160,0

### 1 KDN + PILOT PUMP

MODEL	CODE	P2 (kW)
1KDN 32-160.1/161 3 T400/50 EN12845 COMPACT-JET	60174529	3,0
1KDN 32-160.1/169 4 T400/50 EN12845 COMPACT-JET	60174530	4,0
1KDN 32-160.1/177 5,5 T400/50 EN12845 COMPACT-JET	60174531	5,5
1KDN 32-160/177 5,5 T400/50 EN12845 COMPACT-JET	60174532	5,5
1KDN 32-200.1/190 5,5 T400/50 EN12845 COMPACT-JET	60174533	5,5
1KDN 32-200.1/200 5,5 T400/50 EN12845 COMPACT-JET	60174537	5,5
1KDN 32-200.1/207 7,5 T400/50 EN12845 COMPACT-JET	60174536	7,5
1KDN 32-200/180 5,5 T400/50 EN 12845 COMPACT-JET	60174538	5,5
1KDN 32-200/190 7,5 T400/50 EN12845 COMPACT-JET	60174534	7,5
1KDN 32-200/200 7,5 T400/50 EN12845 COMPACT-JET	60174535	7,5
1KDN 32-200/210 11 T400/50 EN12845 COMPACT-JET	60174541	11,0
1KDN 32-200/219 11 T400/50 EN12845 COMPACT-JET	60174539	11,0
1KDN 32-250/257 15 T400/50 EN12845 COMPACT-KVCX	60176469	15,0
1KDN 40-160/161 7,5 T400/50 EN 12845 COMPACT-JET	60174543	7,5
1KDN 40-160/177 11 T400/50 EN 12845 COMPACT-JET	60174542	11,0
1KDN 40-200/200 11 T400/50 EN 12845 COMPACT-JET	60174540	11,0
1KDN 40-200/219 15 T400/50 EN12845 COMPACT-JET	60176470	15,0
1KDN 40-250/230 15 T400/50 EN12845 COMPACT-JET	60176471	15,0
1KDN 40-250/240 18,5 T400/50 EN12845 COMPACT-JET	60176472	18,5
1KDN 40-250/260 30 T400/50 EN12845 COMPACT-JET	60176473	30,0
1KDN 50-160/161 11 T400/50 EN12845 COMPACT-JET	60176474	11,0
1KDN 50-160/177 15 T400/50 EN12845 COMPACT-JET	60176475	15,0
1KDN 50-200/190 15 T400/50 EN12845 COMPACT-JET	60176476	15,0
1KDN 50-200/210 18,5 T400/50 EN12845 COMPACT-JET	60176477	18,5
1KDN 50-200/219 22 T400/50 EN12845 COMPACT-JET	60176478	22,0
1KDN 50-250/230 22 T400/50 EN12845 COMPACT-JET	60176479	22,0
1KDN 50-250/250 30 T400/50 EN12845 COMPACT-JET	60176480	30,0
1KDN 50-250/263 37 T400/50 EN12845 COMPACT-KV	60176481	37,0
1KDN 65-160/153 11 T400/50 EN12845 COMPACT-JET	60176482	11,0
1KDN 65-200/190 18,5 T400/50 EN12845 COMPACT-JET	60176483	18,5
1KDN 65-200/200 22 T400/50 EN12845 COMPACT-JET	60176484	22,0
1KDN 65-250/230 30 T400/50 EN12845 COMPACT-JET	60176485	30,0
1KDN 65-250/250 37 T400/50 EN12845 COMPACT-KVCX	60176486	37,0
1KDN 65-250/263 45 T400/50 EN12845 COMPACT-KVCX	60176487	45,0
1KDN 65-315/275 55 T400/50 EN12845 COMPACT-KV 3/15	60176488	55,0
1KDN 65-315/290 75 T400/50 EN12845 COMPACT-KV 3/15	60176489	75,0
1KDN 65-315/305 90 T400/50 EN12845 COMPACT-KV 3/18	60176490	90,0
1KDN 65-315/320 110 T400/50 EN12845 COMPACT-KV 3/18	60176491	110,0
1KDN 80-160/177 30 T400/50 EN12845 COMPACT-KVCX 65-80	60176492	30,0
1KDN 80-200/200 37 T400/50 EN12845 COMPACT-KVCX 65-80	60176493	37,0
1KDN 80-250/240 55 T400/50 EN12845 COMPACT-KVCX 65-80	60176494	55,0
1KDN 80-250/260 75 T400/50 EN12845 COMPACT-KVCX 65-80	60176495	75,0
1KDN 80-250/270 90 T400/50 EN12845 COMPACT-KVCX 65-80	60176496	90,0
1KDN 80-315/290 110 T400/50 IE3 EN12845 COMPACT-KV 3/15	60178896	110,0
1KDN100-200/200 55 T400/50 EN12845 COMPACT-KVCX65-80	60176497	55,0
1KDN100-200/219 75 T400/50 EN12845 COMPACT-KVCX65-80	60176498	75,0
1KDN100-250/240 90 T400/50 EN12845 COMPACT-KVCX65-80	60176499	90,0
1KDN100-250/260 110 T400/50 EN12845 COMPACT-KVCX65-80	60176500	110,0
1KDN125-250/235 90 T400/50 IE3 EN12845 COMPACT-KV3/12	60179280	90,0
1KDN125-250/264 160 T400/50 IE3 EN12845 COMPACT - KV6/11	60182178	160,0
1KDN125-330/300 160 T400/50 IE3 EN12845 COMPACT-KV3/12	60181997	160,0

# 1 KDN COMPACT

FIRE -FIGHTING BOOSTER SETS UNI EN12845 WITH ELECTRIC PUMP AND DIESEL PUMP



## TECHNICAL DATA - 1 DIESEL PUMP KDN

### 1 KDN

MODEL	CODE	P2 (kW)
1KDN 32-160.1/161 7.1 MD EN12845 COMPACT	60174385	7,1
1KDN 32-160.1/169 7.1 MD EN12845 COMPACT	60174384	7,1
1KDN 32-160.1/177 7.1 MD EN12845 COMPACT	60174383	7,1
1KDN 32-160/177 7.1 MD EN12845 COMPACT	60173356	7,1
1KDN 32-200.1/190 7.1 MD EN12845 COMPACT	60174382	7,1
1KDN 32-200.1/200 7.1 MD EN12845 COMPACT	60174381	7,1
1KDN 32-200.1/207 7.1 MD EN12845 COMPACT	60173361	7,1
1KDN 32-200/180 7.1 MD EN 12845 COMPACT	60173384	7,1
1KDN 32-200/190 7.1 MD EN12845 COMPACT	60174380	7,1
1KDN 32-200/200 7.1 MD EN12845 COMPACT	60173134	7,1
1KDN 32-200/210 11 MD EN12845 COMPACT	60174379	11,0
1KDN 32-200/219 11 MD EN12845 COMPACT	60173190	11,0
1KDN 32-250/257 15 MD EN12845 COMPACT	60176372	15,0
1KDN 40-160/161 7.1 MD EN12845 COMPACT	60172897	7,1
1KDN 40-160/177 11 MD EN12845 COMPACT	60173228	11,0
1KDN 40-200/200 11 MD EN12845 COMPACT	60174378	11,0
1KDN 40-200/219 15 MD EN12845 COMPACT	60176373	15,0
1KDN 40-250/230 19 MD EN12845 COMPACT	60176374	19,0
1KDN 40-250/240 19 MD EN12845 COMPACT	60176375	19,0
1KDN 40-250/260 26 MD EN12845 COMPACT	60176376	26,0
1KDN 50-160/161 11 MD EN12845 COMPACT	60173241	11,0
1KDN 50-160/177 15 MD EN12845 COMPACT	60176377	15,0
1KDN 50-200/190 15 MD EN12845 COMPACT	60176378	15,0
1KDN 50-200/210 19 MD EN12845 COMPACT	60176379	19,0
1KDN 50-200/219 26 MD EN12845 COMPACT	60176380	26,0
1KDN 50-250/230 26 MD EN12845 COMPACT	60176381	26,0
1KDN 50-250/250 37 MD EN12845 COMPACT	60176382	37,0
1KDN 50-250/263 37 MD EN12845 COMPACT	60176383	37,0
1KDN 65-160/153 11 MD EN12845 COMPACT	60173270	11,0
1KDN 65-200/190 19 MD EN 12845 COMPACT	60176384	19,0
1KDN 65-200/200 26 MD EN12845 COMPACT	60176385	26,0
1KDN 65-250/230 26 MD EN12845 COMPACT	60176386	26,0
1KDN 65-250/250 37 MD EN12845 COMPACT	60176387	37,0
1KDN 65-250/263 53 MD EN12845 COMPACT	60176388	53,0
1KDN 65-315/275 53 MD EN12845 COMPACT	60176389	53,0
1KDN 65-315/290 73.5 MD EN12845 COMPACT	60176390	73,5
1KDN 65-315/305 110 MD EN12845 COMPACT	60176391	110,0
1KDN 65-315/320 110 MD EN12845 COMPACT	60176392	110,0
1KDN 80-160/177 26 MD EN12845 COMPACT	60176393	26,0
1KDN 80-200/200 37 MD EN12845 COMPACT	60176394	37,0
1KDN 80-250/240 73.5 MD EN12845 COMPACT	60176395	73,5
1KDN 80-250/260 110 MD EN12845 COMPACT	60176396	110,0
1KDN 80-250/270 110 MD EN12845 COMPACT	60176397	110,0
1KDN 80-315/290 110 MD EN12845 COMPACT	60178893	110,0
1KDN 100-200/200 53 MD EN12845 COMPACT	60176398	53,0
1KDN 100-200/219 73.5 MD EN12845 COMPACT	60176399	73,5
1KDN 100-250/240 110 MD EN12845 COMPACT	60176400	110,0
1KDN 100-250/260 110 MD EN12845 COMPACT	60176402	110,0
1KDN 125-250/235 110 MD EN12845 COMPACT	60179313	110,0
1KDN 125-250/264 145 MD EN12845 S.C. COMPACT	60178962	145,0
1KDN 125-330/300 164 MD EN12845 COMPACT	60181996	164,0

### 1 KDN + PILOT PUMP

MODEL	CODE	P2 (kW)
1KDN 32-160.1/161 7.1 MD EN12845 COMPACT-JET	60174514	7,1
1KDN 32-160.1/169 7.1 MD EN12845 COMPACT-JET	60174515	7,1
1KDN 32-160.1/177 7.1 MD EN12845 COMPACT-JET	60174516	7,1
1KDN 32-160/177 7.1 MD EN12845 COMPACT-JET	60174517	7,1
1KDN 32-200.1/190 7.1 MD EN12845 COMPACT-JET	60174518	7,1
1KDN 32-200.1/200 7.1 MD EN12845 COMPACT-JET	60174519	7,1
1KDN 32-200.1/207 7.1 MD EN12845 COMPACT-JET	60174521	7,1
1KDN 32-200/180 7.1 MD EN 12845 COMPACT-JET	60174522	7,1
1KDN 32-200/190 7.1 MD EN12845 COMPACT-JET	60174523	7,1
1KDN 32-200/200 7.1 MD EN12845 COMPACT-JET	60174520	7,1
1KDN 32-200/210 11 MD EN12845 COMPACT-JET	60174524	11,0
1KDN 32-200/219 11 MD EN12845 COMPACT-JET	60174526	11,0
1KDN 32-250/257 15 MD EN12845 COMPACT-KVCX	60176436	15,0
1KDN 40-160/161 7.1 MD EN12845 COMPACT-JET	60174528	7,1
1KDN 40-160/177 11 MD EN12845 COMPACT-JET	60174527	11,0
1KDN 40-200/200 11 MD EN12845 COMPACT-JET	60174525	11,0
1KDN 40-200/219 15 MD EN12845 COMPACT-JET	60176437	15,0
1KDN 40-250/230 19 MD EN12845 COMPACT-JET	60176438	19,0
1KDN 40-250/240 19 MD EN12845 COMPACT-JET	60176439	19,0
1KDN 40-250/260 26 MD EN12845 COMPACT-JET	60176440	26,0
1KDN 50-160/161 11 MD EN12845 COMPACT-JET	60176441	11,0
1KDN 50-160/177 15 MD EN12845 COMPACT-JET	60176442	15,0
1KDN 50-200/190 15 MD EN12845 COMPACT-JET	60176443	15,0
1KDN 50-200/210 19 MD EN12845 COMPACT-JET	60176444	19,0
1KDN 50-200/219 26 MD EN12845 COMPACT-JET	60176445	26,0
1KDN 50-250/230 26 MD EN12845 COMPACT-JET	60176446	26,0
1KDN 50-250/250 37 MD EN12845 COMPACT-JET	60176447	37,0
1KDN 50-250/263 37 MD EN12845 COMPACT-KV 3/12	60176448	37,0
1KDN 65-160/153 11 MD EN12845 COMPACT-JET	60176449	11,0
1KDN 65-200/190 19 MD EN 12845 COMPACT-JET	60176450	19,0
1KDN 65-200/200 26 MD EN12845 COMPACT-JET	60176451	26,0
1KDN 65-250/230 26 MD EN12845 COMPACT-JET	60176452	26,0
1KDN 65-250/250 37 MD EN12845 COMPACT-KVCX 65-80	60176453	37,0
1KDN 65-250/263 53 MD EN12845 COMPACT-KVCX 65-80	60176454	53,0
1KDN 65-315/275 53 MD EN12845 COMPACT-KV 3/15	60176455	53,0
1KDN 65-315/290 73.5 MD EN12845 COMPACT-KV 3/15	60176456	73,5
1KDN 65-315/305 110 MD EN12845 COMPACT-KV 3/18	60176457	110,0
1KDN 65-315/320 110 MD EN12845 COMPACT-KV 3/18	60176458	110,0
1KDN 80-160/177 26 MD EN12845 COMPACT-KVCX65-80	60176459	26,0
1KDN 80-200/200 37 MD EN12845 COMPACT-KVCX65-80	60176460	37,0
1KDN 80-250/240 73.5 MD EN12845 COMPACT-KVCX65-80	60176461	73,5
1KDN 80-250/260 110 MD EN12845 COMPACT-KVCX65-80	60176462	110,0
1KDN 80-250/270 110 MD EN12845 COMPACT-KVCX65-80	60176463	110,0
1KDN 100-200/200 53 MD EN12845 COMPACT-KVCX65-80	60176464	53,0
1KDN 100-200/219 73.5 MD EN12845 COMPACT-KVCX65-80	60176465	73,5
1KDN 100-250/240 110 MD EN12845 COMPACT-KVCX65-80	60176466	110,0
1KDN 100-250/260 110 MD EN12845 COMPACT-KVCX65-80	60176468	110,0
1KDN 125-250/264 145 MD EN S.C. COMPACT - KV 6/11	60178963	145,0

Available on request Diesel Fire-fighting Booster Sets with heat exchanger for diesel motor starting from the power P2=37 kW

# 1 KVT

## DIESEL AND ELECTRIC EN 12845 FIRE-FIGHTING SETS WITH VERTICAL TURBINE PUMPS



DIESEL MODULE      ELECTRIC MODULE

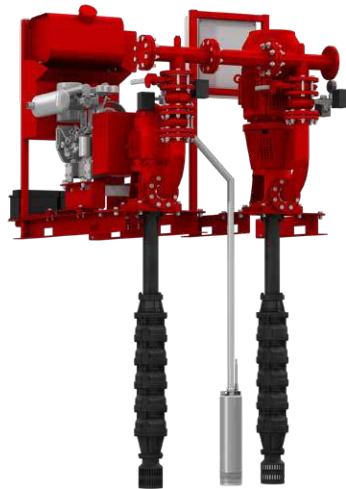

The new 1KVT fire-fighting pump sets with diesel engine or electric motor assembly, ideal for automatic sprinkler systems and/or hydrants of commercial buildings, are manufactured using vertical turbine pumps, in accordance with article 10.6.1 of UNI EN 12845 standards.

### Simple Maintenance:

Thanks to the submersible pump body and the motor assembly control above the surface, they eliminate any self-priming issues, in addition to making the job of the maintenance technician much easier.

### Modular design:

DAB pressurisation sets are designed to be coupled with each other, in order to obtain all the versions and meet all the requirements of the UNI EN 12845 standard.

### Available set models:

#### - 1 KVT ..... EN

, consisting of an axial flow submersible pump (vertical turbine pump) with electric motor, including submersible pump, cork plug, control head installed on appropriate base, electric control panel.

#### - 1 KVT ..... MD EN

, consisting of an axial flow submersible pump (vertical turbine pump) with air-cooled diesel engine or with radiator (with exchanger on request), including submersible pump, cork plug, control head installed on appropriate base, electric control panel, diesel tank ensuring 6 hours of operation, and with fuel collection tank for powers up to 26 kW.

### Operating range

from 4 to 300 m<sup>3</sup>/h

**Pumped liquid** clean, free of solids and abrasives, non-viscous, non-aggressive, non-crystallised and chemically neutral, with properties similar to water.

### Liquid temperature range

from 0 to 40°C

### Maximum ambient temperature

+ 40°C

### Maximum operating pressure

16 bar (1600kPa) PN16

### Special executions on request

diesel version with water/water heat exchanger, 230 three-phase 50 or 60 Hz electric versions, non standard performance.

## UNI EN 12845

ACCESSORIES  
PAG. 367

## FEATURES



### VERTICAL TURBINE PUMP

Vertical turbine pumps offer the great advantage of flooded suction installation even with an underground tank (UNI EN 12845 – 10.6.1). Vertical turbine pumps have a cataphoresis paint coating and cork plug, and can be coupled with an electric motor or diesel engine through a control head installed on an appropriate base.



### COUPLING KIT

In order to obtain all the versions contemplated by the standard (2-3 pump sets), DAB supplies as accessory a coupling kit, to be fitted between the delivery manifolds of the individual sets.



### TANK

Each diesel engine driven pump has a diesel tank that guarantees 6 hours of operation. For engine powers up to 26 kW, a collection tank is also included (in compliance with UNI 11292), for the containment of any fuel spillages.



### ANTI-VORTEX PLATE

Vertical turbine pumps can be equipped with anti-vortex plates to decrease the speed on the suction side (UNI EN 12845 – 9.3.5), in order to make the most of the volume of the storage tank.

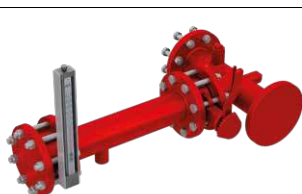

### FLOW METER

The measuring kit with flow meter must be installed on a branch on the delivery manifold of the set. It is used to check the performance of the main pumps.



### AXIAL LINE

The axial line is a flanged pipe treated with black cataphoresis paint coating and equipped with a transmission shaft that connects the submersible pump to the control head, with the corresponding guide supports. (separate accessory)



### CONTROL HEAD

Control head connected to the motor with 3-part spacer coupling. This means the 2 components (motor or pump) can be removed separately in accordance with UNI EN 12845 – 10.1.



### JOCKEY PUMP

Submersible jockey pump with 20-litre expansion vessel and its own electric control panel.



# 1 KVT

DIESEL AND ELECTRIC EN 12845 FIRE-FIGHTING SETS WITH VERTICAL TURBINE PUMPS

## PERFORMANCE OF THE 1KVT

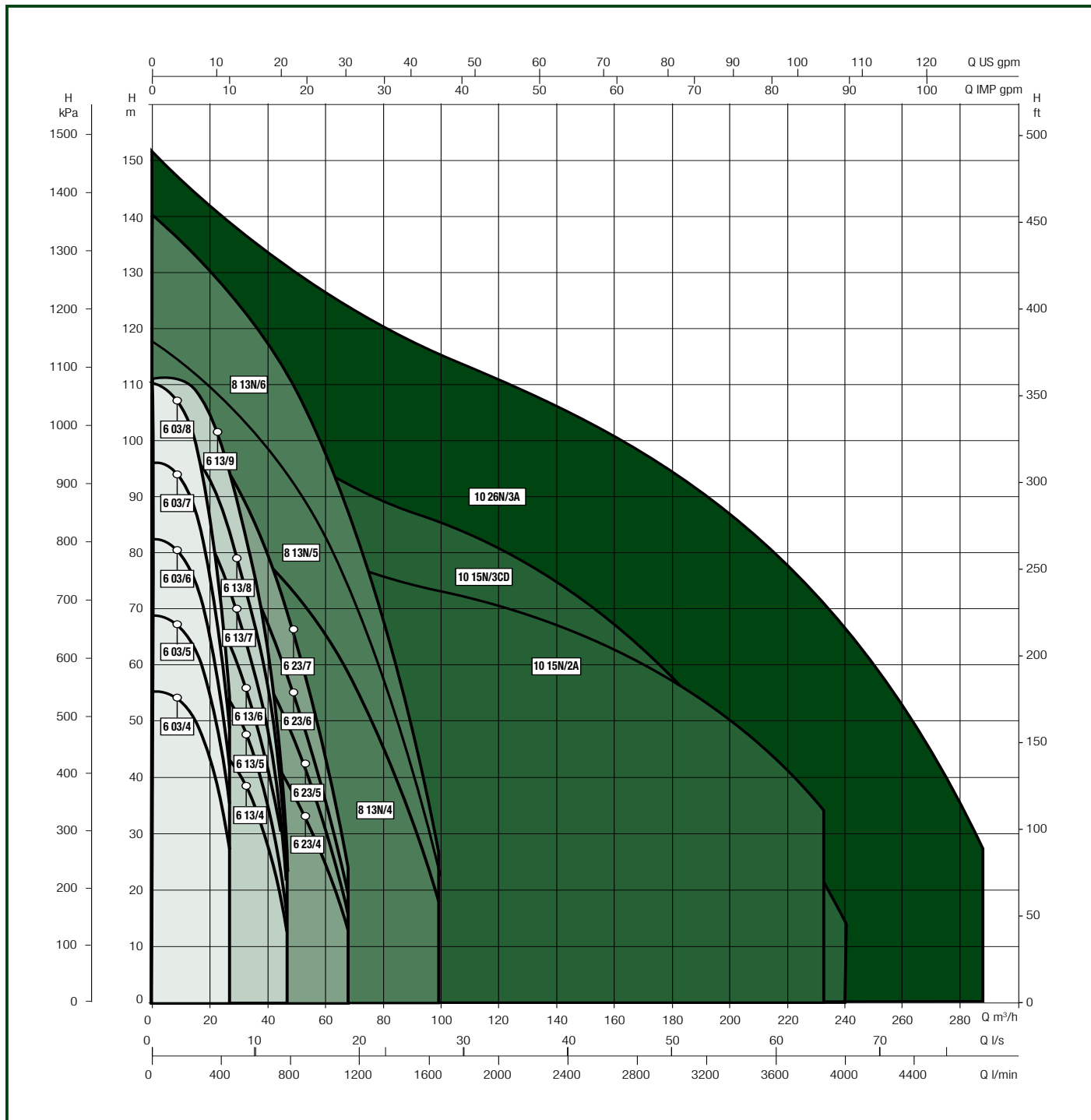

### RANGE OF THE 1KVT

FLOW: UP TO 300 m<sup>3</sup>/h

HEAD: UP TO 150 m.



# 1 KVT

DIESEL AND ELECTRIC EN 12845 FIRE-FIGHTING SETS WITH VERTICAL TURBINE PUMPS



## EXAMPLES OF INSTALLATION WITH 1KDN



### FLOODED SUCTION INSTALLATION

The standards set down, in order of preference, the various ways in which a pump for a fire-fighting set can be installed.

End-suction horizontal pumps must be installed with flooded suction whenever possible, and the standard EN12845 clearly defines the parameters for flooded suction installation:

- at least two thirds the effective capacity of the suction tank must be above the axial line of the pump;
- the axial line of the pump must not be more than 2 m above the minimum level of water in the supply tank.

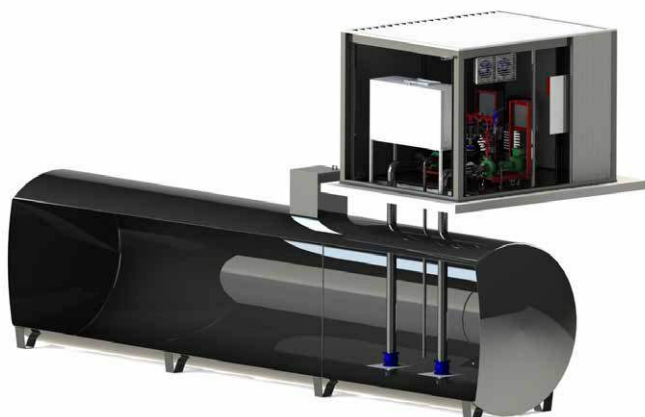

### SUCTION LIFT INSTALLATION

Suction lift installation is the alternative when flooded suction installation is not possible. Standard EN12845, however, advises against suction lift installation and specifies that it should be considered only when flooded suction installation is not feasible.

The standard indicates a maximum distance of 3.2 m between the axial line of the pumps and the lowest point of the suction piping.

Specific priming pumps must also be installed above the main pumps (1 per main pump) to ensure that these are all primed.

## EXAMPLES OF INSTALLATION WITH 1KVT

### FLOODED SUCTION INSTALLATION

Standard EN12845 recommends the use of vertical turbine pumps when flooded suction installation with end-suction horizontal pumps is not possible. Vertical turbine pumps offer the great advantage, in fact, of flooded suction installation even with an underground tank.

Thanks to the submersible pump body and the motor assembly control above the surface, they eliminate any self-priming issues, in addition to making the job of the maintenance technician much easier.

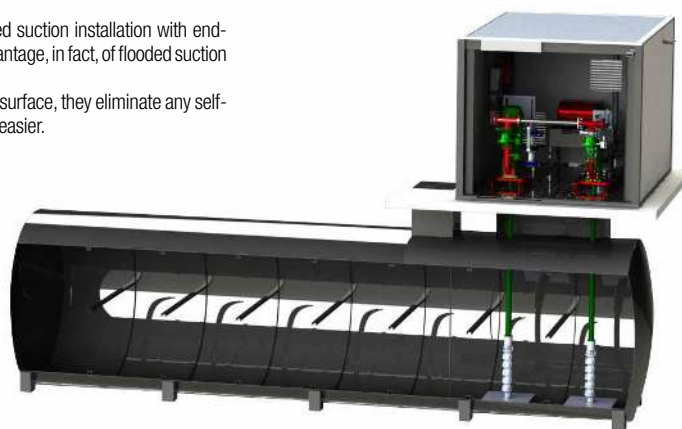

# 1 KVT

DIESEL AND ELECTRIC EN 12845 FIRE-FIGHTING SETS WITH VERTICAL TURBINE PUMPS



## 1 KVT WITH ELECTRIC MOTOR

MODEL	CODE	P2 (kW)	JOCKEY PUMP FOR COUPLING
1KVT6 03/4 5,5 400/50 EN12845	60179712	5,5	DIVER 150 T
1KVT6 03/5 7,5 400/50 EN12845	60179713	7,5	DIVER 150 T
1KVT6 03/6 7,5 400/50 EN12845	60179714	7,5	DIVER 200 T
1KVT6 03/7 11 400/50 EN12845	60179715	11,0	DIVER 200 T
1KVT6 03/8 11 400/50 EN12845	60179716	11,0	DIVER 200 T
1KVT6 13/4 7,5 400/50 EN12845	60179699	7,5	DIVER 150 T
1KVT6 13/5 7,5 400/50 EN12845	60179698	11,0	DIVER 150 T
1KVT6 13/6 11 400/50 EN12845	60179700	11,0	DIVER 150 T
1KVT6 13/7 11 400/50 EN12845	60179696	11,0	DIVER 200 T
1KVT6 13/8 15 400/50 EN12845	60179697	15,0	DIVER 200 T
1KVT6 13/9 15 400/50 EN12845	60179701	15,0	DIVER 200 T
1KVT6 23/4 11 400/50 EN12845	60179705	11,0	DIVER 150 T
1KVT6 23/5 11 400/50 EN12845	60179704	11,0	DIVER 150 T
1KVT6 23/6 15 400/50 EN12845	60179703	15,0	DIVER 150 T
1KVT6 23/7 18,5 400/50 EN12845	60179702	18,5	DIVER 200 T
1KVT8 13N/4 18,5 400/50 EN12845	60179708	18,5	DIVER 200 T
1KVT8 13N/5 22 400/50 EN12845	60179710	22,0	DIVER 200 T
1KVT8 13N/6 30 400/50 EN12845	60179707	30,0	DIVER 200 T
1KVT8 24N/5 30 400/50 EN12845	60186094	30,0	S4 A 25 T
1KVT8 35N/5 37 400/50 EN12845	60187304	37,0	S4 A 25 T
1KVT8 45N/2 18,5 400/50 EN12845	60183462	18,5	DIVER 200 T
1KVT8 45N/4 37 400/50 EN12845	60184292	37,0	DIVER 200 T
1KVT8 45N/5 45 400/50 EN12845	60197641	45,0	S4 A 25 T
1KVT10 15N/2A 45 400/50 EN12845	60179709	45,0	DIVER 200 T
1KVT10 15N/3CD 55 400/50 EN12845	60179706	55,0	DIVER 200 T
1KVT10 26N/3A 75 400/50 EN12845	60179711	75,0	DIVER 200 T

Possibility of requesting diesel engines with water/water exchanger cooling systems

## 1 KVT WITH DIESEL MOTOR

MODEL	CODE	P2 (kW)	JOCKEY PUMP FOR COUPLING
1KVT6 03/4 7,1 MD EN12845	60179673	7,1	DIVER 150 T
1KVT6 03/5 7,1 MD EN12845	60179674	7,1	DIVER 150 T
1KVT6 03/6 11 MD EN12845	60179675	11,0	DIVER 200 T
1KVT6 03/7 11 MD EN12845	60179676	11,0	DIVER 200 T
1KVT6 03/8 11 MD EN12845	60179677	11,0	DIVER 200 T
1KVT6 13/4 7,1 MD EN12845	60179681	7,1	DIVER 150 T
1KVT6 13/5 11 MD EN12845	60179679	11,0	DIVER 150 T
1KVT6 13/6 11 MD EN12845	60179680	11,0	DIVER 150 T
1KVT6 13/7 11 MD EN12845	60179682	11,0	DIVER 200 T
1KVT6 13/8 15 MD EN12845	60179678	15,0	DIVER 200 T
1KVT6 13/9 15 MD EN12845	60179684	15,0	DIVER 200 T
1KVT6 23/4 11 MD EN12845	60179685	11,0	DIVER 150 T
1KVT6 23/5 15 MD EN12845	60179686	15,0	DIVER 150 T
1KVT6 23/6 15 MD EN12845	60179683	15,0	DIVER 150 T
1KVT6 23/7 19 MD EN12845	60179687	19,0	DIVER 200 T
1KVT8 13N/4 19 MD EN12845	60179689	19,0	DIVER 200 T
1KVT8 13N/5 26 MD EN12845	60179690	26,0	DIVER 200 T
1KVT8 13N/6 37 MD EN12845	60179691	37,0	DIVER 200 T
1KVT8 24N/5 37 MD EN12845	60186095	37,0	S4 A 25 T
1KVT8 35N/5 37 MD EN12845 S.C.	60187305	37,0	S4 A 25 T
1KVT8 45N/2 19 MD EN12845	60183461	19,0	DIVER 200 T
1KVT8 45N/4 37 MD EN12845 S.C.	60184309	37,0	DIVER 200 T
1KVT8 45N/5 53 MD EN12845 S.C.	60197637	53,0	S4 A 25 T
1KVT10 15N/2A 53 MD EN12845	60179688	53,0	DIVER 200 T
1KVT10 15N/3CD 73,5 MD EN12845	60179692	73,5	DIVER 200 T
1KVT10 26N/3A 73,5 MD EN12845	60179693	73,5	DIVER 200 T

## ACCESSORIES

KIT PUMP SYSTEM	DESCRIPTION	CODE
	PUMP SYSTEM DIVER 150 T EN 12845	60180500
	PUMP SYSTEM DIVER 200 T EN 12845	60180501
	PUMP SYSTEM S4A 25 400/50 EN 12845	60186116

including 18 l expansion vessel, electric control panel, valves for the connection of the jockey pump to the main KVT pump.

# 1 KVT

DIESEL AND ELECTRIC EN 12845 FIRE-FIGHTING SETS WITH VERTICAL TURBINE PUMPS



## ACCESSORIES

LINE SHAFT	MODEL AND LENGTH*	CODE
	3A20L LINESHAFT Ø142 L=500	60179642
	3A20L LINESHAFT Ø142 L=750	60179641
	3A20L LINESHAFT Ø142 L=1000	60179640
	3A20L LINESHAFT Ø142 L=1500	60179639
	3A20L LINESHAFT Ø142 L=2000	60179638
	3A20L LINESHAFT Ø142 L=2500	60179637
	3A20L LINESHAFT Ø142 L=3050	60179636
	3A24L LINESHAFT Ø142 L=500	60179647
	3A24L LINESHAFT Ø142 L=750	60179644
	3A24L LINESHAFT Ø142 L=1000	60179643
	3A24L LINESHAFT Ø142 L=1500	60179649
	3A24L LINESHAFT Ø142 L=2000	60179645
	3A24L LINESHAFT Ø142 L=2500	60179646
	3A24L LINESHAFT Ø142 L=3050	60179648
	5A24L LINESHAFT Ø191 L=500	60179656
	5A24L LINESHAFT Ø191 L=750	60179655
	5A24L LINESHAFT Ø191 L=1000	60179654
	5A24L LINESHAFT Ø191 L=1500	60179653
	5A24L LINESHAFT Ø191 L=2000	60179652
	5A24L LINESHAFT Ø191 L=2500	60179651
	5A24L LINESHAFT Ø191 L=3050	60179650
	5A27L LINESHAFT Ø191 L=500	60179663
	5A27L LINESHAFT Ø191 L=750	60179662
	5A27L LINESHAFT Ø191 L=1000	60179661
	5A27L LINESHAFT Ø191 L=1500	60179660
	5A27L LINESHAFT Ø191 L=2000	60179659
	5A27L LINESHAFT Ø191 L=2500	60179658
	5A27L LINESHAFT Ø191 L=3050	60179657
	6A30L LINESHAFT Ø240 L=500	60179670
	6A30L LINESHAFT Ø240 L=750	60179669
	6A30L LINESHAFT Ø240 L=1000	60179668
	6A30L LINESHAFT Ø240 L=1500	60179667
	6A30L LINESHAFT Ø240 L=2000	60179666
	6A30L LINESHAFT Ø240 L=2500	60179665
	6A30L LINESHAFT Ø240 L=3050	60179664
	3A20L LINESHAFT SPECIAL LENGTH TO ORDER ON REQUEST FROM 0,6 M UP TO 2,95 M	-
	3A24L LINESHAFT SPECIAL LENGTH TO ORDER ON REQUEST FROM 0,6 M UP TO 2,95 M	-
	5A24L LINESHAFT SPECIAL LENGTH TO ORDER ON REQUEST FROM 0,6 M UP TO 2,95 M	-
	5A27L LINESHAFT SPECIAL LENGTH TO ORDER ON REQUEST FROM 0,6 M UP TO 2,95 M	-
	6A30L LINESHAFT SPECIAL LENGTH TO ORDER ON REQUEST FROM 0,6 M UP TO 2,95 M	-



The axial line is a flanged pipe treated with black cataphoresis paint coating that connects the submersible pump to the control head, with the corresponding guide supports.

\* L Length in mm (500 to 3050 mm)

# S4 - SS6 - SS7 - SS8

FIRE FIGHTING UNITS UNI STANDARDS EN 12845 WITH 4" - 6" - 7" - 8" SUBMERSIBLE ELECTRIC PUMPS



## TECHNICAL DATA

Fire-fighting pump groups made according to the specifications of the European standard UNI EN 12845. Fixed fire-fighting installations-automatic sprinkler systems.

All pumps (main and jockey) are equipped with 15 meter power input cable.

The 6" - 7" - 8" pumps are fully made of AISI 304 stainless steel.

## OVERVIEW OF THE UNI-EN 12845

The UNI-EN 12845, the Italian version of the European standard UNI-EN 12845, establishes the criteria for the design, installation and maintenance of sprinkler systems.

An automatic sprinkler system is designed to detect the presence of fire and extinguish it in the initial stage or to keep the flames under control until the extinction can be completed by other means. The classic sprinkler system includes:

a water supply, a group of fire pumps, control valves and a network of pipelines with sprinkler. The main pump continues to run until it is stopped manually using the STOP button on the control panel. In the case of fire hydrant networks, you should refer to the UNI 10779 - July 07. UNI 10779, in addition to requiring the power pumps according to EN 12845, admits, in the case of activity not constantly manned, the automatic shutdown of the pumps after 20 minutes of closing the hydrants. DAB groups are suited for both sprinkler networks with manual shutdown and for hydrant networks with automatic stop.

## OPERATION OF FIRE FIGHTING PUMP GROUPS AS PER UNI EN 12845

Under normal conditions (zero water demand), the system is under static pressure. On the first request of water the compensating pump is started that restores the system pressure. If the demand for water is significant (fire sprinkler opening) the system pressure drops until the two pressure switches connected in series activate the main pump. The two pressure starter switches must be calibrated so that you can start the pumps at the following pressure values:

**Operating range** from 4 to 160 m<sup>3</sup>/h

**Pumped liquid** clean, free of solids and abrasives, non-viscous, non-aggressive, non-crystallised and chemically neutral, with properties similar to water.

**Pumped liquid temperature range** from -15 to 70 °C.

**Maximum ambient temperature** + 25 °C

**Maximum operating pressure** 16 bar (1600kPa) PN16

**Special executions on request** execution with joined cable available on request.

The control panels of the sets with submerged pumps are already fitted on base for quicker installation.

The main and pilot pumps are provided as standard with a 15-metre power cable.

All the 6" and 8" electric pumps (SS6 - SS7 and SS8) are entirely in AISI 304 stainless steel.



## UNI EN 12845

ACCESSORIES  
PAG. 367

ONE PUMP SETS	P = 0,8 X MAX. PUMP PRESSURE	
SETS WITH TWO PUMPS	PUMP 1: P1 = 0,8 X MAX PRESSURE	PUMP 2: P2 = 0,6 X MAX PRESSURE

Es: Max. pressure 10 bar - pump 1 starts at 8 bar, pump 2 starts at 6 bar

# S4 - SS6 - SS7 - SS8

FIRE FIGHTING UNITS UNI STANDARDS EN 12845 WITH 4" - 6" - 7" - 8" SUBMERSIBLE ELECTRIC PUMPS



## 4" SUBMERSIBLE ELECTRIC PUMPS

### 1 S4 PUMP

MODEL	CODE
1S4E 12 T 400/50 EN 12845 15 MT CABLE	60171466
1S4E 17 T 400/50 EN 12845 15 MT CABLE	60171467
1 S4E 20 T 400/50 EN 12845 15 MT CABLE	60171468
1S4F 7 T 400/50 EN 12845 15 MT CABLE	60171469
1S4F 10 T 400/50 EN 12845 15 MT CABLE	60171470
1S4F 13 T 400/50 EN 12845 15 MT CABLE	60171471
1S4F 18 T 400/50 EN 12845 15 MT CABLE	60171472

### 1 S4 + PILOT PUMP

MODEL	CODE
1S4E 12 T 400/50 EN 12845 - S4C 19T 15 MT CABLE	60171473
1S4E 17 T 400/50 EN 12845 - S4C 25T 15 MT CABLE	60171474
1S4E 20 T 400/50 EN 12845 - S4C 25T 15 MT CABLE	60171478
1S4F 7 T 400/50 EN 12845 - S4C 13T 15 MT CABLE	60171479
1S4F 10 T 400/50 EN 12845 - S4C 13T 15 MT CABLE	60171483
1S4F 13 T 400/50 EN 12845 - S4C 19T 15 MT CABLE	60171485
1S4F 18 T 400/50 EN 12845 - S4C 25T 15 MT CABLE	60171486

## 6" SUBMERSIBLE ELECTRIC PUMPS

### 1 SS6 PUMP

MODEL	CODE
1 SS6 C06 T 400/50 EN 12845 WITH CABLE	60171488
1 SS6 C08 T 400/50 EN 12845 WITH CABLE	60171492
1 SS6 C11 T 400/50 EN 12845 WITH CABLE	60171494
1 SS6 D04 T 400/50 EN 12845 WITH CABLE	60171495
1 SS6 D05 T 400/50 EN 12845 WITH CABLE	60171497
1 SS6 D06 T 400/50 EN 12845 WITH CABLE	60171501
1 SS6 D07 T 400/50 EN 12845 WITH CABLE	60171503
1 SS6 D09 T 400/50 EN 12845 WITH CABLE	60171504
1 SS6 E03 T 400/50 EN 12845 WITH CABLE	60171505
1 SS6 E04 T 400/50 EN 12845 WITH CABLE	60171506
1 SS6 E05 T 400/50 EN 12845 WITH CABLE	60171508
1 SS6 E06 T 400/50 EN 12845 WITH CABLE	60171510
1 SS6 E07 T 400/50 EN 12845 WITH CABLE	60171513
1 SS6 E08 T 400/50 EN 12845 WITH CABLE	60171514

### 1 SS6 + PILOT PUMP

MODEL	CODE
1 SS6 C06 T 400/50 EN 12845 - S4 C19T WITH CABLE	60171516
1 SS6 C08 T 400/50 EN 12845 - S4 C19T WITH CABLE	60171517
1 SS6 C11 T 400/50 EN 12845 - S4 C25T WITH CABLE	60171573
1 SS6 D04 T 400/50 EN 12845 - S4 C13T WITH CABLE	60171690
1 SS6 D05 T 400/50 EN 12845 - S4 C19T WITH CABLE	60171704
1 SS6 D06 T 400/50 EN 12845 - S4 C19T WITH CABLE	60171390
1 SS6 D07 T 400/50 EN 12845 - S4 C19T WITH CABLE	60171705
1 SS6 D09 T 400/50 EN 12845 - S4 C25T WITH CABLE	60171708
1 SS6 E03 T 400/50 EN 12845 - S4 C13 WITH CABLE	60171711
1 SS6 E04 T 400/50 EN 12845 - S4 C13 WITH CABLE	60171721
1 SS6 E05 T 400/50 EN 12845 - S4 C19 WITH CABLE	60171722
1 SS6 E06 T 400/50 EN 12845 - S4 C19 WITH CABLE	60171726
1 SS6 E07 T 400/50 EN 12845 - S4 C25 WITH CABLE	60171728
1 SS6 E08 T 400/50 EN 12845 - S4 C25 WITH CABLE	60171729

## 7"- 8" SUBMERSIBLE ELECTRIC PUMPS

### 1 SS7-SS8 PUMP

MODEL	CODE
1SS7 A4 T 400/50 EN 12845 15 MT CABLE	60177100
1SS7 A5 T 400/50 EN 12845 15 MT CABLE	60177101
1SS7 A6 T 400/50 EN 12845 15 MT CABLE	60177102
1SS7 B3 T 400/50 EN 12845 15 MT CABLE	60177103
1SS7 B4 T 400/50 EN 12845 15 MT CABLE	60177104
1SS7 B5 T 400/50 EN 12845 15 MT CABLE	60177105
1SS8 A3 T 400/50 EN 12845 15 MT CABLE	60177106
1SS8 A4 T 400/50 EN 12845 15 MT CABLE	60177107
1SS8 A5 T 400/50 EN 12845 15 MT CABLE	60177108
1SS8 B3B.3 T 400/50 EN 12845 15 MT CABLE	60177109
1SS8 B3 T 400/50 EN 12845 15 MT CABLE	60177110
1SS8 B4 T 400/50 EN 12845 15 MT CABLE	60177111

### 1 SS7-SS8 + PILOT PUMP

MODEL	CODE
1SS7 A4 T 400/50 EN 12845 - S4C 19T 15 MT CABLE	60177114
1SS7 A5 T 400/50 EN 12845 - S4C 19T 15 MT CABLE	60177115
1SS7 A6 T 400/50 EN 12845 - S4C 25T 15 MT CABLE	60177117
1SS7 B3 T 400/50 EN 12845 - S4C 19T 15 MT CABLE	60177118
1SS7 B4 T 400/50 EN 12845 - S4C 25T 15 MT CABLE	60177119
1SS7 B5 T 400/50 EN 12845 - S4C 25T 15 MT CABLE	60177120
1SS8 A3 T 400/50 EN 12845 - S4C 19T 15 MT CABLE	60177122
1SS8 A4 T 400/50 EN 12845 - S4C 19T 15 MT CABLE	60177124
1SS8 A5 T 400/50 EN 12845 - S4C 25T 15 MT CABLE	60177125
1SS8 B3B.3 T 400/50 EN 12845 - S4C 19T 15 MT CABLE	60177126
1SS8 B3 T 400/50 EN 12845 - S4C 25T 15 MT CABLE	60177127
1SS8 B4 T 400/50 EN 12845 - S4C 25T 15 MT CABLE	60177128

# 1/2 NKV

## FIRE-FIGHTING PUMP UNITS TO EN 12845 WITH VERTICAL NKV PUMPS



### TECHNICAL DATA

Fire-fighting pump units manufactured in compliance with the prescriptions of European standard UNI EN 12845. Fixed fire-fighting installations – Automatic sprinkler systems

### NOTES ON UNI EN 12845

UNI EN 12845, the Italian version of European standard EN 12845, establishes design, installation and maintenance criteria for sprinkler systems and it replaces the earlier Italian standards UNI 9489 and UNI 9490.

An automatic sprinkler system is designed to detect the presence of fire and extinguish it in the initial stages, or to keep flames under control until they can be extinguished fully using ancillary means.

The classic sprinkler system is composed of: a water source, a fire-fighting pump unit, a series of control valves, and a sprinklers circuit.

The main pump continues to run until it is stopped manually by pressing the STOP pushbutton on the control panel.

In the case of hydrant circuits refer to the prescriptions of UNI 10779-July 07. UNI 10779, as well as stating that fire-fighting pumps must be in compliance with the requirements of UNI EN 12845, also permits, in the case of work not constantly supervised, automatic

stopping of the pumps 20 minutes after closure of the hydrants.

DAB pump sets are suitable for sprinkler installations with manual stopping and for hydrant installations with automatic stopping.

### OPERATION OF EN 12845 FIRE-FIGHTING PUMP SET

In normal conditions (zero water demand) the system is maintained under static pressure.

The first demand for water results in start-up of the jockey pump, which restores system pressure. If a significant flow rate of water is demanded (opening of sprinklers), the pressure will drop until the two pressure switches connected in series trip to start up the main pump.

The two start-up pressure switches must be calibrated in such a way as to start the pumps at the following pressure values.

**Operating range** from 4 to 29 m<sup>3</sup>/h

**Pumped liquid** clean, free of solids and abrasives, non-viscous, non-aggressive, non-crystallised and chemically neutral, with properties similar to water.

**Pumped liquid temperature range** from -15 to 70 °C.

**Maximum ambient temperature** + 40°C

**Maximum operating pressure** 16 bar (1600 kPa) PN16

### UNI EN 12845

ACCESSORIES  
PAG. 367

ONE PUMP SETS	P = 0,8 X MAX. PUMP PRESSURE	
SETS WITH TWO PUMPS	PUMP 1: P1 = 0,8 X MAX PRESSURE	PUMP 2: P2 = 0,6 X MAX PRESSURE

Es: Max. pressure 10 bar - pump 1 starts at 8 bar, pump 2 starts at 6 bar

# 1/2 NKV

FIRE-FIGHTING PUMP UNITS TO EN 12845 WITH VERTICAL NKV PUMPS



## 1/2 NKV PUMPS

MODEL	CODE
1NKV 10/3 T400/50 EN12845	60118437
1NKV 10/4 T400/50 EN12845	60118438
1NKV 10/5 T400/50 EN12845	60118439
1NKV 10/6 T400/50 EN12845	60118440
1NKV 10/7 T400/50 EN12845	60118441
1NKV 10/8 T400/50 EN12845	60118442
1NKV 10/9 T400/50 EN12845	60118443
1NKV 10/10 T400/50 EN12845	60118444
1NKV 10/12 T400/50 EN12845	60118445
1NKV 10/14 T400/50 EN12845	60118446
1NKV 15/3 T400/50 EN12845	60118447
1NKV 15/4 T400/50 EN12845	60118448
1NKV 15/5 T400/50 EN12845	60118451
1NKV 15/6 T400/50 EN12845	60118452
1NKV 15/7 T400/50 EN12845	60118456
1NKV 15/8 T EN 12845	60169070
1NKV 15/9 T EN 12845	60169071
1NKV 15/10 T EN 12845	60169072
1NKV 20/3 T400/50 EN12845	60118464
1NKV 20/4 T400/50 EN12845	60118465
1NKV 20/5 T400/50 EN12845	60118466
1NKV 20/6 T EN 12845	60169073
1NKV 20/7 T EN 12845	60169074
1NKV 20/8 T EN 12845	60169075
1NKV 20/9 T EN 12845	60169076
1NKV 20/10 T EN 12845	60169077

MODEL	CODE
2NKV 10/3 T400/50 EN12845	60118498
2NKV 10/4 T400/50 EN12845	60118499
2NKV 10/5 T400/50 EN12845	60118500
2NKV 10/6 T400/50 EN12845	60118501
2NKV 10/7 T400/50 EN12845	60118502
2NKV 10/8 T400/50 EN12845	60118503
2NKV 10/9 T400/50 EN12845	60118504
2NKV 10/10 T400/50 EN12845	60118505
2NKV 10/12 T400/50 EN12845	60118506
2NKV 10/14 T400/50 EN12845	60118507
2NKV 15/3 T400/50 EN12845	60118533
2NKV 15/4 T400/50 EN12845	60118534
2NKV 15/5 T400/50 EN12845	60118535
2NKV 15/6 T400/50 EN12845	60118536
2NKV 15/7 T400/50 EN12845	60118537
2NKV 15/8 T EN 12845	60169091
2NKV 15/9 T EN 12845	60169092
2NKV 15/10 T EN 12845	60169093
2NKV 20/3 T400/50 EN12845	60118541
2NKV 20/4 T400/50 EN12845	60118542
2NKV 20/5 T400/50 EN12845	60118543
2NKV 20/6 T EN 12845	60169094
2NKV 20/7 T EN 12845	60169098
2NKV 20/8 T EN 12845	60169108
2NKV 20/9 T EN 12845	60169127
2NKV 20/10 T EN 12845	60169128

## 1/2 NKV PUMPS + PILOT PUMP

MODEL	CODE
1NKV 10/3 T400/50 EN12845 - JET	60118472
1NKV 10/4 T400/50 EN12845 - JET	60118473
1NKV 10/5 T400/50 EN12845 - JET	60118474
1NKV 10/6 T400/50 EN12845 - JET	60118475
1NKV 10/7 T400/50 EN12845 - KV 3/10	60118476
1NKV 10/8 T400/50 EN12845 - KV 3/12	60118477
1NKV 10/9 T400/50 EN12845 - KV 3/12	60118478
1NKV 10/10 T400/50 EN12845 - KV 3/18	60118479
1NKV 10/12 T400/50 EN12845 - KV 3/18	60118480
1NKV 10/14 T400/50 EN12845 - KV 3/18	60118481
1NKV 15/3 T400/50 EN12845 - JET	60118482
1NKV 15/4 T400/50 EN12845 - JET	60118483
1NKV 15/5 T400/50 EN12845 - JET	60118484
1NKV 15/6 T400/50 EN12845 - KV 3/12	60118485
1NKV 15/7 T400/50 EN12845 - KV 3/12	60118486
1NKV 15/8 T400/50 EN12845 - KV 3/18	60169078
1NKV 15/9 T400/50 EN12845 - KV 3/18	60169079
1NKV 15/10 T400/50 EN12845 - KV 3/18	60169080
1NKV 20/3 T400/50 EN12845 - JET	60118490
1NKV 20/4 T400/50 EN12845 - JET	60118491
1NKV 20/5 T400/50 EN12845 - JET	60118492
1NKV 20/6 T400/50 EN12845 - KV 3/12	60169081
1NKV 20/7 T400/50 EN12845 - KV 3/18	60169082
1NKV 20/8 T400/50 EN12845 - KV 3/18	60169083
1NKV 20/9 T400/50 EN12845 - KV 3/18	60169084
1NKV 20/10 T400/50 EN12845 - KV 3/18	60169085

MODEL	CODE
2NKV 10/3 T400/50 EN12845 - JET	60118549
2NKV 10/4 T400/50 EN12845 - JET	60118550
2NKV 10/5 T400/50 EN12845 - JET	60118551
2NKV 10/6 T400/50 EN12845 - JET	60118552
2NKV 10/7 T400/50 EN12845 - KV 3/10	60118553
2NKV 10/8 T400/50 EN12845 - KV 3/12	60118554
2NKV 10/9 T400/50 EN12845 - KV 3/12	60118555
2NKV 10/10 T400/50 EN12845 - KV 3/18	60118556
2NKV 10/12 T400/50 EN12845 - KV 3/18	60118557
2NKV 10/14 T400/50 EN12845 - KV 3/18	60118558
2NKV 15/3 T400/50 EN12845 - JET	60118559
2NKV 15/4 T400/50 EN12845 - JET	60118560
2NKV 15/5 T400/50 EN12845 - JET	60118561
2NKV 15/6 T400/50 EN12845 - KV 3/12	60118562
2NKV 15/7 T400/50 EN12845 - KV 3/12	60118563
2NKV 15/8 T400/50 EN12845 - KV 3/18	60169129
2NKV 15/9 T400/50 EN12845 - KV 3/18	60169131
2NKV 15/10 T400/50 EN12845 - KV 3/18	60169132
2NKV 20/3 T400/50 EN12845 - JET	60118567
2NKV 20/4 T400/50 EN12845 - JET	60118568
2NKV 20/5 T400/50 EN12845 - JET	60118569
2NKV 20/6 T400/50 EN12845 - KV 3/12	60169133
2NKV 20/7 T400/50 EN12845 - KV 3/18	60169134
2NKV 20/8 T400/50 EN12845 - KV 3/18	60169135
2NKV 20/9 T400/50 EN12845 - KV 3/18	60169136
2NKV 20/10 T400/50 EN12845 - KV 3/18	60169137







# **PRESSURE UNITS ACCESSORIES - FIRE FIGHTING BOOSTING SETS UNI EN 12845**

---

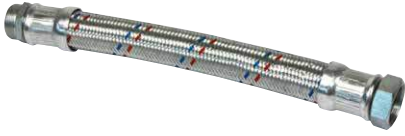

# ACCESSORIES

## PRESSURE UNITS

FLEXIBLE HOSE	MODEL	CODE
	FLEXIBLE HOSE 1" 1/2 MF	002260316
	FLEXIBLE HOSE 2" 1/2 MF 10B	60118994

ANTI-VIBRATION THREADED UNION	MODEL	CODE
	ANTI-VIBRATION THREADED UNION FF 2" - PN 16	002139107
	ANTI-VIBRATION THREADED UNION FF 2" 1/2 - PN 16	002139108

BALL VALVE	MODEL	CODE
	BALL VALVE MF 1" (FOR EXPANSION VASSEL SERVICING)	002132054



PRESSURE	MODEL	CODE
	MIN. PRESS. SWITCH XMP A06L 1/4" F IP 43	002717002
	KIT PRESSURE SWITCH FOR DRY RUNNING PROTECTION	547120850
	KIT PRESSURE SWITCH FOR OVERPRESS.	547120860

# ACCESSORIES

## PRESSURE UNITS

FLOAT	MODEL	CODE
	FLOAT - 5 METER CABLE	159260030
	FLOAT - 10 METER CABLE	159260040

AIR INLET COUPLING KIT	MODEL	CODE
	1" AIR INLET COUPLING KIT	547120440
	1" 1/4 AIR INLET COUPLING KIT	547120450
	1" 1/2 AIR INLET COUPLING KIT	547120460

TANK	MODEL	CODE
 <p>TANK WITH <b>5 YEARS</b> OF GUARANTEE </p>	8 LT. TANK 10 BAR V - G	60141866
	18 LT. TANK 10 BAR V - G	60141867
	18 LT. TANK 16 BAR V - G	60141868

EXCHANGE STARTING MODULE	MODEL	CODE
	EXCHANGE STARTING MODULE SZ 3	002773493

PRESSURE TRANSMITTER	MODEL	CODE
	PRESS. TRAS. 16 BAR (FOR B. SETS WITH CONTR. PANEL E-BOX )	60116837

# ACCESSORIES

## PRESSURE UNITS

ANTI-VIBRATING JOINT	MODEL	CODE
 <p>FF 2"1/2 PN16 ANTI-VIBRATION JOINT</p>	FF 2"1/2 PN16 ANTI-VIBRATION JOINT	002139108
	ANTI-VIBRATING JOINT DN 80 - KDN 32	002139209
	ANTI-VIBRATING JOINT DN 100 - KDN 40	002139210
	ANTI-VIBRATING JOINT DN 125 - KDN 50	002139211
	ANTI-VIBRATING JOINT DN 150 - KDN 65	002139212
	ANTI-VIBRATING JOINT DN 200 - KDN 80-160/KDN 80-200	002139263
	ANTI-VIBRATING JOINT DN 250 - KDN 100 - KDN 80-250/80-315	002139264
	ANTI-VIBRATING JOINT DN 300	002139215

KIT PRESSURE SWITCH	MODEL	CODE
	KIT PRESSURE SWITCH FOR DRY RUNNING PROTECTION	547120850

FOOT VALVE WITH FILTER	MODEL	CODE
 <p>DN 80 FOOT VALVE WITH FILTER</p>	DN 80 FOOT VALVE WITH FILTER	60111919
	DN 100 FOOT VALVE WITH FILTER	60111920
	DN 125 FOOT VALVE WITH FILTER	60111921
	DN 150 FOOT VALVE WITH FILTER	60111922
	DN 200 FOOT VALVE WITH FILTER	60111923
	DN 250 FOOT VALVE WITH FILTER	60111925
	DN 300 FOOT VALVE WITH FILTER	60111926

# ACCESSORIES

FIRE FIGHTING UNITS UNI STANDARDS EN 12845

SUCTION KIT		DESCRIPTION	KDN	1/2 NKV	S4 - SS 6/7/8	KVT	CODE
 <p><b>PRESSURE GAUGE INCLUDED</b></p>	<p>The kit is composed of an eccentric cone with screws, nuts and seals. It maintains the water speed in suction below 1.5 m/s and prevents the formation of air pockets. The following is required:</p> <ul style="list-style-type: none"> <li>- 1 KIT for 1NKV units</li> <li>- 2 KITS for units 2NKV</li> </ul>	SUCTION KIT FOR NKV 10 EN 12845 (DN 65)		•			60124052
		SUCTION KIT KDN 32 EN (DN 80)	•	•			60124053
		SUCTION KIT KDN 40 EN (DN 100)	•				60124054
		SUCTION KIT KDN 50 EN (DN 125)	•				60124055
		SUCTION KIT KDN 65 EN (DN 150)	•				60124056
		SUCTION KIT KDN 80 EN (DN 200)	•				60124057
		SUCTION KIT KDN 80-250/80-315 EN (DN 250)	•				60161992
		SUCTION KIT KDN 100 EN (DN 250)	•				60124058
		SUCTION KIT KDN125 (DN300)	•				60178890

JOINT MANIFOLD KIT		DESCRIPTION	KDN	1/2 NKV	S4 - SS 6/7/8	KVT	CODE
	<p>Only in the case of units comprising two modules (electric pump and/or Diesel pump) 1 coupling KIT is required.</p>	JOINT MANIFOLD KIT 2KDN 32 EN COMPACT	•				60174547
		JOINT MANIFOLD KIT 2KDN 40 EN COMPACT	•				60174548
		JOINT MANIFOLD KIT 2KDN 50 EN COMPACT	•			•	60178472
		JOINT MANIFOLD KIT 2KDN 65 EN COMPACT	•				60178473
		JOINT MANIFOLD KIT 2KDN 80 EN COMPACT	•			•	60178474
		JOINT MANIFOLD KIT 2KDN 100 EN COMPACT	•			•	60178475
		JOINT MANIFOLD KIT 2KDN125 EN COMPACT	•			•	60178892

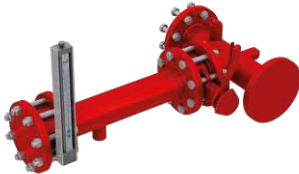
FLOW METER KIT		DESCRIPTION	KDN	1/2 NKV	S4 - SS 6/7/8	KVT	CODE
	<p>The measuring kit with flow meter must be installed on a branch on the delivery manifold of the set.</p> <ul style="list-style-type: none"> <li>• 1 MEASURING KIT is sufficient for both 1 and 2 1KDN and 1KVT sets (electric or diesel)</li> <li>• 1 flow meter KIT is sufficient for both 1NKV and 2NKV sets.</li> </ul>	1 S4 - EN 12845 - FLOW METER KIT			•		60140932
		1 SS6 - EN 12845 - FLOW METER KIT			•		60140933
		1 SS7 - 1 SS8 - EN 12845 - FLOW METER KIT			•		60118872
		FLOW METER KIT - NKV 10 EN 12845		•			60118575
		FLOW METER KIT KDN 100 EN		•			60118576
		FLOW METER KIT KDN 32 EN COMPACT	•				60174549
		FLOW METER KIT KDN 40 EN COMPACT	•				60174550
		FLOW METER KIT KDN 50 EN COMPACT	•			•	60178477
		FLOW METER KIT KDN 65 EN COMPACT	•				60178478
		FLOW METER KIT KDN 80 EN COMPACT	•			•	60178479
		FLOW METER KIT KDN 100 EN COMPACT	•			•	60178480

# ACCESSORIES

FIRE FIGHTING UNITS UNI STANDARDS EN 12845

FLOW METER		DESCRIPTION	KDN	1/2 NKV	S4 - SS 6/7/8	KVT	CODE
 <p>Single flow meter (measuring device) to be installed on the delivery</p>		FLOW METER DN 40 (3,5-25 M3/H) 1-2 NKV 10 -1S4		•	•		002789103
		FLOW METER DN 50 (7-50 m³/h) KDN 32 - NKV 15-20	•	•			002789104
		FLOW METER DN 65 (10-80 m³/h) KDN 40 - SS6	•		•		002789105
		FLOW METER DN 80 (17,5-130 m³/h) KDN 50	•			•	002789106
		FLOW METER DN 100 (25-200 m³/h) KDN 65 - SS7 - SS8	•		•		002789107
		FLOW METER DN 125 (40-300 m³/h) KDN 80	•			•	002789108
		FLOW METER DN 150 (45-350 m³/h) KDN 100	•			•	002789109
		FLOW METER DN 200 (800 m³/H) KDN 125	•			•	002789110

REMOTE ALARM SIGNAL PANEL		DESCRIPTION	KDN	1/2 NKV	S4 - SS 6/7/8	KVT	CODE
	Suitable for sets with 1 to 3 pumps	REMOTE ALARM SIGNAL PANEL EFIRE MONITOR (EN 12845)	•	•	•	•	60180517

REMOTE ALARM SIGNAL PANEL		DESCRIPTION	KDN	1/2 NKV	S4 - SS 6/7/8	KVT	CODE
	Suitable for sets with 1 or 2 pumps	REMOTE ALARM SIGNAL PANEL CSR 1	•	•	•	•	60118970

GSM MODULE		DESCRIPTION	KDN	1/2 NKV	S4 - SS 6/7/8	KVT	CODE
	Delivery of alarm signal to mobile phone	GSM MODULE FOR CSR1	•	•	•	•	60161270

BUTTERFLY VALVE		DESCRIPTION	KDN	1/2 NKV	S4 - SS 6/7/8	KVT	CODE
 <p>Required for pump maintenance, in case of flooded suction installations. The following is required:</p> <ul style="list-style-type: none"> <li>• N. 1 BUTTERFLY VALVE for units 1KDN (electric or diesel).</li> <li>• N.1 VALVE for units 1NKV and 2 VALVES for units 2NKV</li> </ul>		BUTTERFLY VALVE DN 65		•			002132608
		BUTTERFLY VALVE DN 80 - KDN 32 - NKV 15-20	•	•			002132609
		BUTTERFLY VALVE DN 100 - KDN 40	•				002132610
		BUTTERFLY VALVE DN 125 - KDN 50	•				002132661
		BUTTERFLY VALVE DN 150 - KDN 65	•				002132662
		BUTTERFLY VALVE DN 200 - KDN 80	•				002132663
		BUTTERFLY VALVE DN 250 - KDN 100	•				002132664
		BUTTERFLY VALVE DN 300 - KDN 125	•				002132665

# ACCESSORIES

FIRE FIGHTING UNITS UNI STANDARDS EN 12845

FOOT VALVE WITH FILTER		DESCRIPTION	KDN	1/2 NKV	S4 - SS 6/7/8	KVT	CODE
 <p>These are required to maintain priming of the pump suction, in overhead installations. The following is required:</p> <ul style="list-style-type: none"> <li>• 1 FOOT VALVE for each 1KDN set (electric or Diesel).</li> <li>• 1 VALVE for units 1NKV and 2 VALVES for units 2NKV</li> </ul>	DN 65 FOOT VALVE WITH FILTER		•			60117394	
	FOOT VALVE WITH FILTER DN 80	•	•			60111919	
	FOOT VALVE WITH FILTER DN 100	•				60111920	
	FOOT VALVE WITH FILTER DN 125	•				60111921	
	FOOT VALVE WITH FILTER DN 150	•				60111922	
	FOOT VALVE WITH FILTER DN 200	•				60111923	
	FOOT VALVE WITH FILTER DN 250 (1KDN 100 - 1KDN 80-250/80-315)	•				60111925	
	FOOT VALVE WITH FILTER DN 300 (KDN 125)	•				60111926	





ANTI-VIBRATION COUPLING FOR SUCTION LINES		DESCRIPTION	KDN	1/2 NKV	S4 - SS 6/7/8	KVT	CODE
 <p>The antivibration coupling is utilised to reduce the amount of vibration transmitted to the system, this being especially important when the prime mover is a Diesel engine.</p> <ul style="list-style-type: none"> <li>• 1 COUPLING is sufficient for 1 KDN sets (electric or Diesel) (Not compulsory according to UNI EN 12845)</li> <li>• 1 COUPLING is necessary for 1NKV units and 2 COUPLINGS for 2NKV unit</li> </ul>	ANTI-VIBRATION JOINT DN65 PN16		•			002139208	
	ANTI-VIBRATION JOINT DN80 PN16	•	•			002139209	
	ANTI-VIBRATION JOINT DN100 PN16	•				002139210	
	ANTI-VIBRATION JOINT DN125 PN16	•				002139211	
	ANTI-VIBRATION JOINT DN150 PN16	•				002139212	
	ANTI-VIBRATION JOINT DN200 PN16	•				002139263	
	ANTI-VIBRATION JOINT DN250 PN16	•				002139264	
	ANTI-VIBRATION JOINT DN300 PN16 - KDN 125	•				002139215	

ANTIVIBRATION COUPLINGS FOR DISCHARGE MANIFOLDS		DESCRIPTION	KDN	1/2 NKV	S4 - SS 6/7/8	KVT	CODE
 <p>The antivibration coupling is utilised to reduce the amount of vibration transmitted to the system, this being especially important when the prime mover is a Diesel engine.</p> <ul style="list-style-type: none"> <li>- 1 COUPLING is sufficient for 1 or 2 KDN sets (electric or Diesel) (Not compulsory according to UNI EN 12845)</li> <li>- 1 COUPLING is sufficient for 1 or 2 NKV sets (electric or Diesel) (Not compulsory according to UNI EN 12845)</li> </ul>	ANTI-VIBRATING JOINT 2" - KDN 32	•	•			002139107	
	ANTI-VIBRATING JOINT 2" 1/2 - KDN 40	•	•			002139108	
	ANTI-VIBRATING JOINT DN 80 - KDN 50	•	•		•	002139209	
	ANTI-VIBRATING JOINT DN 100 - KDN 65	•				002139210	
	ANTI-VIBRATING JOINT DN 125 - KDN 80	•			•	002139211	
	ANTI-VIBRATING JOINT DN 150 - KDN 100	•			•	002139212	
	ANTI-VIBRATING JOINT DN 200 - KDN 125	•				002139263	

PRIMING TANK		DESCRIPTION	KDN	1/2 NKV	S4 - SS 6/7/8	KVT	CODE
	N. 1 per pump	PRIMING TANK (500 LT.) EN 12845	•	•			60110538



# ACCESSORIES

FIRE FIGHTING UNITS UNI STANDARDS EN 12845

KIT PUMP SYSTEM		DESCRIPTION	KDN	1/2 NKV	S4 - SS 6/7/8	KVT	CODE
		<b>PUMP SYSTEM JET 251 T EN 12845</b>	•	•			60111352
	including 18 l expansion vessel, electric control panel, valves for the connection of the jockey pump to the main KDN pump.	<b>PUMP SYSTEM DIVER 150 T EN 12845</b>				•	60180500
		<b>PUMP SYSTEM DIVER 200 T EN 12845</b>				•	60180501
		<b>PUMP SYSTEM S4A 25 400/50 EN 12845</b>			•	•	60186116

FOOT VALVE WITH STRAINER		DESCRIPTION	KDN	1/2 NKV	S4 - SS 6/7/8	KVT	CODE
	No. 1 for each pump	<b>FOOT VALVE WITH STRAINER VR3</b>				•	60179846
		<b>FOOT VALVE WITH STRAINER VA6</b>				•	60179847

ANTI-VORTEX DISPOSITIVE		DESCRIPTION	KDN	1/2 NKV	S4 - SS 6/7/8	KVT	CODE
	Vortex prevention plate, to be installed between the cork plug and the pump body, to maximise the actual capacity of the water reserves No. 1 for each pump	<b>ANTI-VORTEX DISPOSITIVE FOR SU3 AND VR3</b>				•	60180496
		<b>ANTI-VORTEX DISPOSITIVE FOR SU6 AND VA6</b>				•	60180498

GASOLINE HARVESTER TANK		DESCRIPTION	KDN	1/2 NKV	S4 - SS 6/7/8	KVT	CODE
	For 1KDN sets with diesel engines between 15 and 26 kW included. 15 to 26 kW engines	<b>GASOLINE HARVESTER FOR 50 L TANK (ENG. UP TO 26 KW )</b>	•				60176953
	For 1KDN and 1KVT sets with diesel engines between 37 and 110 kW	<b>GASOLINE HARVESTER FOR 125 L TANK (ENG. 37-103 KW )</b>	•			•	60178461
	For 1KDN and 1KVT sets with diesel engines between 145 and 164 kW	<b>GASOLINE HARVESTER 250LT TANK (ENG.145 - 164 KW)</b>	•			•	60168294





# ACCESSORIES

FIRE FIGHTING UNITS UNI STANDARDS EN 12845

SPARE PART KIT FOR DIESEL ENGINE		DESCRIPTION	KDN	1/2 NKV	S4 - SS 6/7/8	KVT	CODE
 <p>Each kit is composed of: a) 2 sets of filter elements and relative seals for fuel; b) 2 sets of filter elements and relative seals for lubricant; c) 2 sets of belts d) 1 complete set of couplings, seals and hoses for the motor; e) 2 injector nozzles.</p>	SPARE PART KIT FOR DIESEL ENGINE 7.1-KW(15LD)	•			•	60175002	
	SPARE PART KIT FOR DIESEL ENGINE 11-KW (25LD)	•			•	60115038	
	SPARE PART KIT FOR DIESEL ENGINE 15-KW (12LD)	•			•	60115039	
	SPARE PART KIT FOR DIESEL ENGINE 19-KW (9LD)	•			•	60115037	
	SPARE PART KIT FOR DIESEL ENGINE 26-KW (11LD)	•			•	60115036	
	SPARE PART KIT FOR DIESEL ENGINE 37-53-KW (D703)	•			•	60115161	
	SPARE PART KIT FOR DIESEL ENGINE 73-KW (D754)	•			•	60115162	
	SPARE PART KIT FOR DIESEL ENGINE 110-KW (D756)	•			•	60115163	
	SPARE PART KIT FOR DIESEL ENGINE 164KW (N45 MN TF 40.10)					60143967	

DIESEL ENGINE WITH HEAT EXCHANGER		DESCRIPTION	KDN	1/2 NKV	S4 - SS 6/7/8	KVT	CODE
 <p>* Surcharge to be added to standard versions</p>	All fire-fighting sets with diesel engine driven pumps and powers starting from 37 kW are equipped as standard with radiator cooling systems. On request, water/water heat exchanger cooled diesel engines are also available, subject to a surcharge to be added to the list prices for diesel engine driven pumps with standard radiator cooling system*	HEAT EXCHANGER WATER/WATER FOR DIESEL ENGINE OF 37 KW	•			•	-
	HEAT EXCHANGER WATER/WATER FOR DIESEL ENGINE OF 53 KW	•			•	-	
	HEAT EXCHANGER WATER/WATER FOR DIESEL ENGINE OF 73.5 KW	•			•	-	
	HEAT EXCHANGER WATER/WATER FOR DIESEL ENGINE OF 110 KW	•			•	-	

KIT FLOW SWITCH		DESCRIPTION	KDN	1/2 NKV	S4 - SS 6/7/8	KVT	CODE
	Suitable for sets with 1 or 2 pumps	KIT FLOW SWITCH 1" EN 12845	•	•	•	•	60114410

RECYCLE FLOW INDICATOR		DESCRIPTION	KDN	1/2 NKV	S4 - SS 6/7/8	KVT	CODE
		RECYCLE FLOW INDICATOR 3/4"	•			•	60120142

# ACCESSORIES

FIRE FIGHTING UNITS UNI STANDARDS EN 12845

COOLING SLEEVE KIT		DESCRIPTION	KDN	1/2 NKV	S4 - SS 6/7/8	KVT	CODE
		KIT COOLING PIPE 4" L.400			•		60125178
		KIT COOLING PIPE 4" L.525			•		60125179
		KIT COOLING PIPE 4" L.885			•		60125180
		COOLING SLEEVE KIT L. 725			•		60144213
		COOLING SLEEVE KIT L. 960			•		60144217
		COOLING SLEEVE KIT L. 1.220			•		60144218
		COOLING SLEEVE KIT L. 1.490			•		60146397

HORIZONTAL POSITIONING KIT		DESCRIPTION	KDN	1/2 NKV	S4 - SS 6/7/8	KVT	CODE
		HORIZONTAL POSITIONING KIT 4"			•		60125181
		HORIZONTAL POSITIONING KIT 6"			•		60146398

FILTER KIT		DESCRIZIONE	KDN	1/2 NKV	S4 - SS 6/7/8	KVT	CODE
		FILTER KIT 4"			•		60125182
		FILTER KIT 6"			•		60146399

PRESSURE SWITCH		DESCRIPTION	CODE
	<p>spare part of pressure switch used for fire-fighting units</p>	<b>PRESSURE SWITCH KPI36 2-12 BAR EN12845</b>	60127439

# GENERAL WARRANTY CONDITIONS

## 1.1. DURATION OF THE WARRANTY

DAB Pumps Spa is committed to supply Products in compliance with the agreements and free from defects that make them unsuitable for the use for which products of the same type are normally intended. All the products, including spare parts, with the exception of Evosta 2 and Evosta 3 are guaranteed against construction material and processing defects for a period of 24 months from the date of delivery or purchase. Such date shall be demonstrated by the delivery document or the invoice issued by DAB Pumps Spa. Should such documentation not be available, the 24-month period shall be calculated from the date of production indicated on the product identification plate.

The wet rotor circulator ranges Evosta 2 and Evosta 3 are instead covered by a warranty for a period of 60 months (5 years) from the date of delivery or purchase (only for EU markets).

## 1.2. WARRANTY TERMS

- 1.2.1** Product conformity defects and faults must be notified in writing, under penalty of expiration of the warranty, within 8 days from the date of delivery of the product, or discovery, in case of hidden conformity defect or fault, or from the date when the buyer could have discovered the conformity defect or fault through an accurate analysis of the product, or, again, from the actual date of receipt of the claim and/or request from third party relating to the Product. All this notwithstanding the General sales conditions.
- 1.2.2** The warranty terms shall be fulfilled through total replacement of the product, or replacement of some components, or free repair, or a price reduction, or, should the payment have already been made, partial return of the amount paid, taking into account the level of use of the product and its age, and only after the existence of the manufacturing defect has been confirmed by the DAB or DAB Service Partner. The latter shall also be requested to check the delivery/purchase documentation before applying the terms of the warranty.
- 1.2.3** The replacement of the product, or any components, shall not result in any changes to the terms of the warranty. This means that the warranty period for the replaced product, or any replaced components, shall still be calculated from the date of purchase or delivery of the original product.
- 1.2.4** The product repaired/replaced under the terms of the warranty shall be returned with freight charges for the account of the recipient (ex our works).
- 1.2.5** The product or the various components replaced will be scrapped by DAB Pumps Spa on behalf of its Customer who has benefited of the warranty, unless requested by the Customer to return the products. This request must be sent to the Customer Service within 5 days from the date of receipt. The shipping costs will be charged to the Customer.
- 1.2.6** The warranty does not cover any direct and indirect damages caused by DAB Pumps Products, including any costs for their removal and reinstallation, or costs for the installation of replacement products, including any products installed while the repairs are being carried out.
- 1.2.7** No warranty related issues shall authorise the Customer to withdraw from its contractual commitments.
- 1.2.8** The warranty is subjected to the compliance by the Customer with the agreed payment terms.
- 1.2.9** The standard warranty terms applied by DAB Pumps Spa do not affect the statutory rights of consumers pursuant to the 1999/44/EU European Directive, acknowledged in Italy with Italian Legislative Decree no. 206/2005, applicable to consumer end users.

## 1.3. LIMITS OF THE WARRANTY

DAB Pumps Spa shall not be liable for conformity defects and products faults in the following cases:

- 1.3.1** if the conformity defect or fault is due to drawings, designs, information, instructions, software, materials, semi-finished products, component or else, supplied by the Buyer, or by any other parties on behalf of the same;
- 1.3.2** if the conformity defect or fault is due to product tampering, or repairs/modifications not carried out by DAB, or by third parties authorised by the same;
- 1.3.3** if the conformity defect or fault is due to incorrect installation of the product;
- 1.3.4** if the conformity defect or fault is due to a failure to protect the product, or to inappropriate protection, or to errors in the connection of the product;
- 1.3.5** if the conformity defect or fault is due to the use of corrosive liquids and/or any liquids not contemplated in the documentation delivered with the product;
- 1.3.6** if the conformity defect or fault is due to the use of liquids with the presence of suspended solids in quantities greater than what is permitted;
- 1.3.7** if the conformity defect or fault is due to normal wear and tear;
- 1.3.8** if the conformity defect or fault is due to an incorrect use of the product (e.g. overloading beyond the limits of the product);
- 1.3.9** if the conformity defect or fault is due to an occurrence taking place after the risks have been transferred to the Buyer;
- 1.3.10** if the conformity defect or fault is due to a proven shortfall or default of the electric system, the supply system, or changes resulting from environmental or climate conditions, or conditions of any other nature;
- 1.3.11** if all the product installation, energy network (electric and water lines) connection, use and maintenance activities have not been carried out in strict compliance with the instructions of the Instruction Booklet, or the documentation delivered with the product;
- 1.3.12** if the conformity defect or fault is due to improper and incorrect use of the product, not in compliance or against the indications of the User and Maintenance Booklet, or if the product is used for purposes other than its intended purpose;
- 1.3.13** if the conformity defect or fault is due to the installation and use of the product not in compliance with technical and safety standards;
- 1.3.14** if the conformity defect or fault has been caused by defects in the plant or equipment to which the product is connected;
- 1.3.15** if the product or goods are damaged during transport carried out by the customer or by appointed transporters;
- 1.3.16** Moreover, the warranty shall not apply in case of:
- use of non-original spare parts;
  - regular maintenance activities, or replacement of components subjected to normal wear;
  - new products, never installed and still sealed;

In general, the warranty does not cover defects not caused by objectively identified construction or material faults.

## 1.4. PRODUCT INSTALLED OUTSIDE COUNTRY

For products installed outside the country, the above conditions shall apply, with the understanding that the product must be sent to the local Service Partner at the expenses of the Customer. Exceptions are the products sold within the European community through traditional channels or web channels (Amazon or Ebay marketplace). In these cases the Customer needs After-sales assistance may choose to use the technical assistance network made available by the DAB branches, where present or official Service Partners. For the identification of the reference DAB Pumps branch, please refer to DAB Pumps website <https://dabpumps.com>.

# CERTIFICATES



THE INTERNATIONAL CERTIFICATION NETWORK

## CERTIFICATE

CISQ/IMQ has issued an IQNet recognized certificate that the organization:

**DWT HOLDING SPA**  
 VIA MARCO POLO 14 - 35035 MESTRINO (PD)  
 BRENDOLA (VI) - CASTELLO DI GODEGO (TV) - BIENTINA (PI) -  
 VAL LIONA (VI) - PRC CHINA - HUNGARY

has implemented and maintains a  
**Quality Management System**

for the following scope:  
**Design, production, sale and assistance of components and electronic controls for pumps, electropumps and pump sets for cold and hot water for civil, industrial and agricultural use**

Further clarifications regarding the applicability of ISO 9001:2015 requirements may be obtained by consulting the organization

which fulfills the requirements of the following standard:  
**ISO 9001:2015**

Issued on: **2018 - 05 - 21**  
 Expires on: **2021 - 05 - 27**

This attestation is directly linked to the IQNet Partner's original certificate and shall not be used as a stand-alone document

Registration Number: IT - 824



Alex Stoichitov  
President of IQNET



Ing. Claudio Proveti  
President of CISQ

**IQNet Partners\***  
 AENOR Spain AFNOR Certification France APICER Portugal CCC Cyprus CISQ Italy  
 CQC China CQM China CQS Czech Republic Cto Cert Croatia DQS Holding GmbH Germany FCAV Brazil  
 FONDONORMA Venezuela ICUNTEC Colombia Inspecta Certification Oy Finland INTECO Costa Rica  
 IRAM Argentina IQA Japan KPO Korea MIREC Greece MESZ Hungary Nemko AS Norway NSAI Ireland  
 NYCE-SIGE Mexico PCBQ Poland Quality Austria Austria RR Russia SII Israel SIQ Slovenia  
 SIRIM QAS International Malaysia SGS Switzerland SRAC Romania TEST St Petersburg Russia TSE Turkey YUQS Serbia  
 IQNet is represented in the USA by: AFNOR Certification, CISQ, DQS Holding GmbH and NSAI Inc.

\* The list of IQNet partners is valid at the time of issue of this certificate. Updated information is available under [www.iqnet-certification.com](http://www.iqnet-certification.com)



www.iqnet.it

ALLEGATO CERTIFICATO n. **9101.COGE**  
 ANNEX CERTIFICATE

(\*) Unità Operative:  
 (\*) Operative Units:

**DAB PUMPS SPA**  
 VIA BONANNO PISANO 1 - 56031 BIENTINA (PI)

**DAB PUMPS SPA**  
 VIA DEL LAVORO 3 - 36040 VAL LIONA (VI)

**DAB PUMPS QINGDAO CO. LTD**  
 40 KAITUO ROAD, QINGDAO DEVELOPMENT ZONE - SHANGDONG PROVINCE, PRC CHINA

**DAB PUMPS HUNGARY KFT**  
 BUDA ERNO H - 8800 NAGYKANISZA HUNGARY

DATE	PRIMA CERTIFICAZIONE FIRST CERTIFICATION	EMISSIONE CORRENTE CURRENT ISSUE	SCADENZA EXPIRY
	1995-07-17	2018-05-21	2021-05-27



IMQ S.p.A. - VIA QUINTILIANO, 43 - 20138 MILANO ITALY  
 Management Systems Division - Flavio Orsago



IAF: 18, 19, 29

SGQ N° 005 A  
 Sistema di Qualità per parti di pompe  
 per uso civile, industriale ed agricolo  
 (in conformità con il Regolamento CE, n° 1706/2005  
 della Commissione Europea)

La validità del certificato è subordinata a sottostanza e sottostanza annuale e rimane completa del sistema di gestione per il periodo di validità.

Organismo di Certificazione Federato CISQ  
[www.iqnet.it](http://www.iqnet.it)

www.cisq.com

CISQ è la Federazione Italiana di Organismi di Certificazione del sistema di gestione aziendale. CISQ è la Public Federation of management system Certification Bodies.



www.iqnet.it

CISQ is a member of



www.iqnet-certification.com

IQNet, the association of the world's first class certification bodies, is the largest provider of management system Certification in the world. IQNet is composed of more than 30 bodies and covers over 150 subsidiaries all over the globe.

CERTIFICATO N. **9101.COGE**  
 CERTIFICATE N. **9101.COGE**

SI CERTIFICA CHE IL SISTEMA QUALITÀ DI  
 WE HEREBY CERTIFY THAT THE QUALITY SYSTEM OPERATED BY

**DWT HOLDING SPA**  
 VIA MARCO POLO 14 - 35035 MESTRINO (PD)

UNITÀ OPERATIVE / OPERATIVE UNITS  
**DAB PUMPS SPA**  
 VIA MARCO POLO 14 - 35035 MESTRINO (PD)  
**DAB PUMPS SPA**  
 VIA EINAUDI 2 - 36040 BRENDOLA (VI)  
**DAB PUMPS SPA**  
 VIA E. FERMI 6-8-10 - 31030 CASTELLO DI GODEGO (TV)

Vedere gli Allegati per le altre Unità Operative (n° 1 pagina)  
 View the Annexes for the other Operative Units (n° 1 page)

E' CONFORME ALLA NORMA / IS IN COMPLIANCE WITH THE STANDARD  
**ISO 9001:2015**

PER LE SEGUENTI ATTIVITÀ / FOR THE FOLLOWING ACTIVITIES

Progettazione, produzione, commercializzazione e assistenza di componenti e controlli elettronici per pompe, elettropompe e gruppi di pompaggio per acqua fredda e calda ad uso civile, industriale ed agricolo  
 Design, production, sale and assistance of components and electronic controls for pumps, electropumps and pump sets for cold and hot water for civil, industrial and agricultural use

IL PRESENTE CERTIFICATO E' SOGGETTO AL RISPETTO DEL  
 REGOLAMENTO PER LA CERTIFICAZIONE DEI SISTEMI DI GESTIONE  
 THE USE AND THE VALIDITY OF THE CERTIFICATE SHALL SATISFY THE  
 REQUIREMENTS OF THE RULES FOR CERTIFICATION OF MANAGEMENT SYSTEMS

DATE	PRIMA CERTIFICAZIONE FIRST CERTIFICATION	EMISSIONE CORRENTE CURRENT ISSUE	SCADENZA EXPIRY
	1995-07-17	2018-05-21	2021-05-27



IMQ S.p.A. - VIA QUINTILIANO, 43 - 20138 MILANO ITALY  
 Management Systems Division - Flavio Orsago



IAF: 18, 19, 29

SGQ N° 005 A  
 Sistema di Qualità per parti di pompe  
 per uso civile, industriale ed agricolo  
 (in conformità con il Regolamento CE, n° 1706/2005  
 della Commissione Europea)

Organismo di Certificazione Federato CISQ  
[www.iqnet.it](http://www.iqnet.it)



www.cisq.com

CISQ è la Federazione Italiana di Organismi di Certificazione del sistema di gestione aziendale. CISQ is the Public Federation of management system Certification Bodies.





## On-line product selection

 **DAB PUMPS LTD.**  
6 Gilberd Court  
Newcomen Way  
Severalls Business Park  
Colchester  
Essex  
CO4 9WN - UK  
salesuk@dwtgroup.com  
Tel. +44 0333 777 5010

 **DAB PUMPS IBERICA S.L.**  
Calle Verano 18-20-22  
28850 - Torrejón de Ardoz - Madrid  
Spain  
Info.spain@dwtgroup.com  
Tel. +34 91 6569545  
Fax: + 34 91 6569676

 **DAB PUMPS SOUTH AFRICA (PTY) LTD**  
Twenty One industrial Estate,  
16 Purlin Street, Unit B, Warehouse 4  
Olifantsfontein -1666 - South Africa  
info.sa@dwtgroup.com  
Tel. +27 12 361 3997

 **DAB PUMPS BV**  
'tHofveld 6 C1  
1702 Groot Bijgaarden - Belgium  
info.belgium@dwtgroup.com  
Tel. +32 2 4668353

 **DAB PUMPS HUNGARY KFT.**  
H-8800  
Nagykanizsa, Buda Ernő u.5  
Hungary  
Tel. +36 93501700

 **DAB PUMPS (QINGDAO) CO. LTD.**  
No.40 Kaituo Road, Qingdao Economic & Technological  
Development Zone  
Qingdao City, Shandong Province - China  
PC: 266500  
sales.cn@dwtgroup.com  
Tel. +86 400 186 8280  
Fax +86 53286812210

 **DAB PUMPS POLAND Sp. z o.o.**  
Ul. Janka Muzykanta 60  
02-188 Warszawa - Poland  
polska@dabpumps.com.pl

 **DAB PUMPS B.V.**  
Albert Einsteinweg, 4  
5151 DL Drunen - Nederland  
info.netherlands@dwtgroup.com  
Tel. +31 416 387280  
Fax +31 416 387299

 **OOO DAB PUMPS**  
Novgorodskaya str. 1, block G  
office 308, 127247, Moscow - Russia  
info.russia@dwtgroup.com  
Tel. +7 495 122 0035  
Fax +7 495 122 0036

 **DAB PUMPS DE MÉXICO, S.A. DE C.V.**  
Av Amsterdam 101 Local 4  
Col. Hipódromo Condesa,  
Del. Cuauhtémoc CP 06170  
Ciudad de México  
Tel. +52 55 6719 0493

 **DAB PUMPS GMBH**  
Am Nordpark 3  
D - 41069 Mönchengladbach - Germany  
info.germany@dwtgroup.com  
Tel. +49 2161 47388-0  
Fax +49 2161 47388-36

 **DAB PUMPS INC.**  
3226 Benchmark Drive  
Ladson, SC 29456 - USA  
info.usa@dwtgroup.com  
Tel. 1- 843-797-5002  
Fax 1-843-797-3366

 **DAB PUMPS OCEANIA PTY LTD**  
426 South Gippsland Hwy,  
Dandenong South VIC 3175 - Australia  
info.oceania@dwtgroup.com  
Tel. +61 1300 373 677