

FEKAFOS MAXI 1200-1700-2200-3600

AUTOMATIC LIFTING STATIONS FOR 2 PUMPS

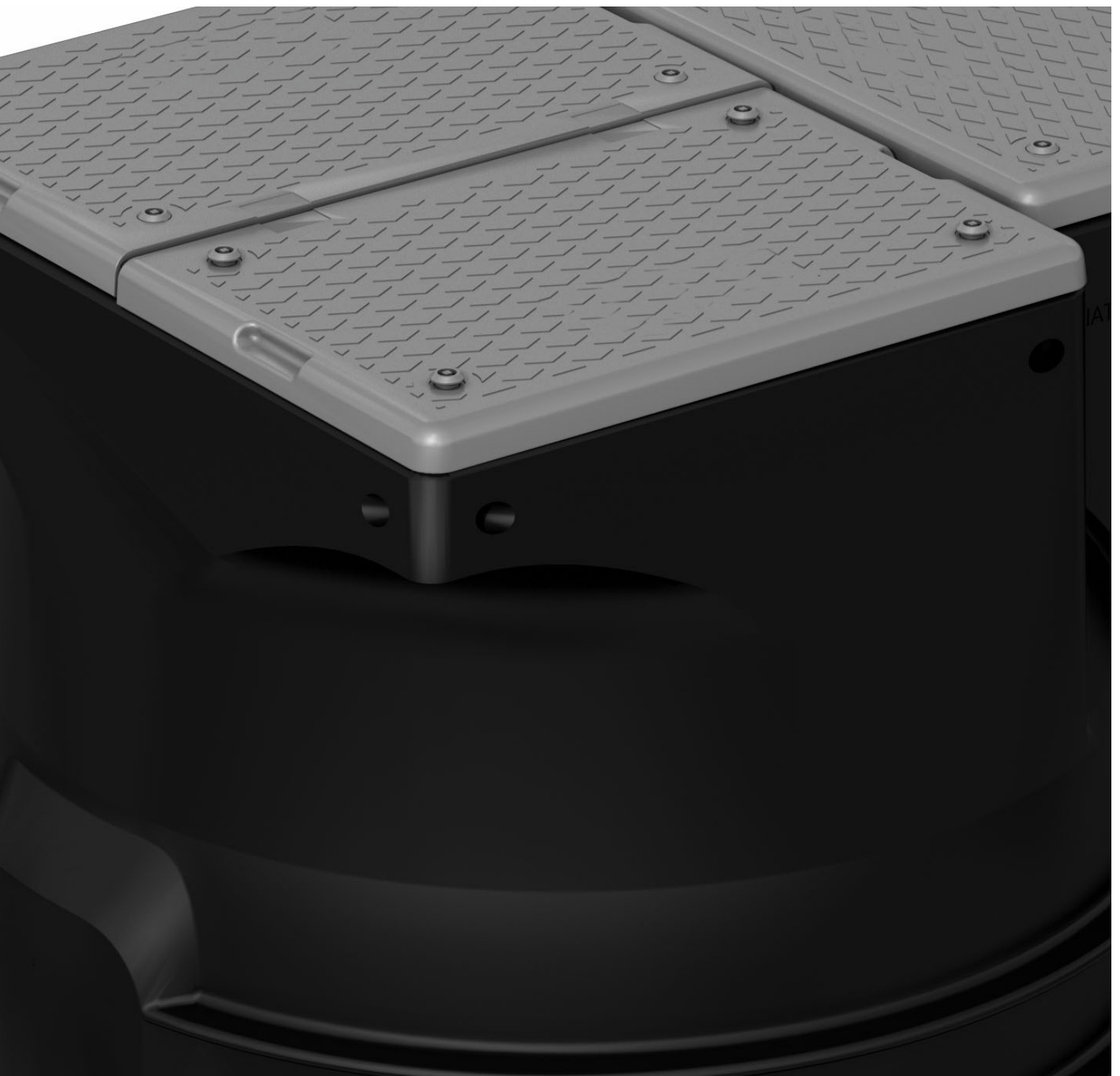

FEKAFOS MAXI 1200 – 1700 - 2200 - 3600

AUTOMATIC LIFTING STATIONS FOR 2 PUMPS



TECHNICAL SPECIFICATIONS

Operating range: From 1 to 160 m³/h with head up to 40 m.

Liquid temperature range: + 55° C

Pumped liquid: groundwater, rainwater, clear waste water, waste sewage water and river or lake water.

Installation: Underground on the outside of a building.

Walk-over load up to 100 kg - Standard installation.

Drive-over load class D400 with appropriate coverage available as an accessory.

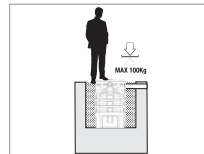

APPLICATIONS

Automatic collection and lifting station suitable for clear and rainwater or civil and industrial waste. Composed of a cylindrical polyethylene monoblock with a suitably shaped bottom to house the pumps and to avoid stagnation. The upper inlet is equipped with lids with locking clasps and anti-odour seals. The station is set up for the use of two single-phase non-automatic or three-phase pumps with a discharge diameter from DN50 to DN80.

CONSTRUCTION CHARACTERISTICS

CAPACITY: 1200 / 1700 / 2200 / 3600 L

MATERIALS: High density polyethylene

CONNECTIONS:

- DN DN125 / DN160 inlets
- DN 50 ventilation
- 2xDN50 / 2xDN65 / 2xDN80 outlets

COMPONENTS INCLUDED:

- 2 coupling units in grey cast iron for insertion and extraction of pumps
- stainless steel guide tubes
- PVC "T" inlet fitting
- 2 polyethylene outlet pipes
- 3 Bulb floats
- Lids with locking clasps and polyethylene anti-odour seals

ACCESSORIES ON REQUEST:

- Valve inspection section complete with two gate valves and grey cast iron check valves
- Anti-intrusion grating.
- Filter basket
- Drive-over frame D400 1200x1200 (To be fixed on site in the concrete structure surrounding the tank)

PUMP INSTALLATION

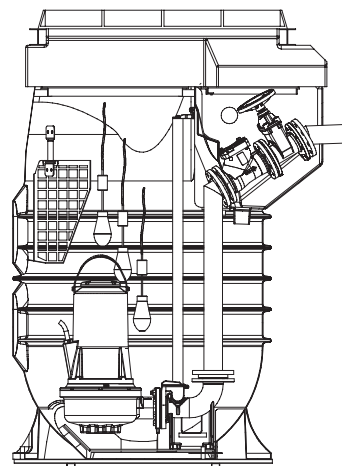
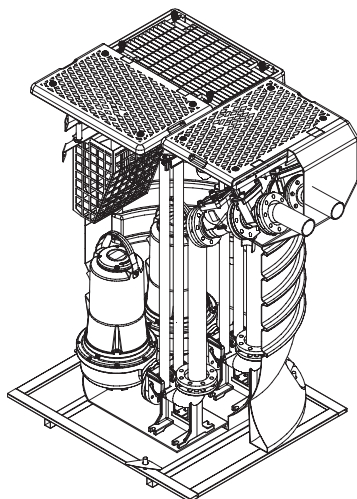

FEKAFOS MAXI 1200 – 1700 - 2200 - 3600

AUTOMATIC LIFTING STATIONS FOR THE COLLECTION AND LIFTING OF WASTE WATER

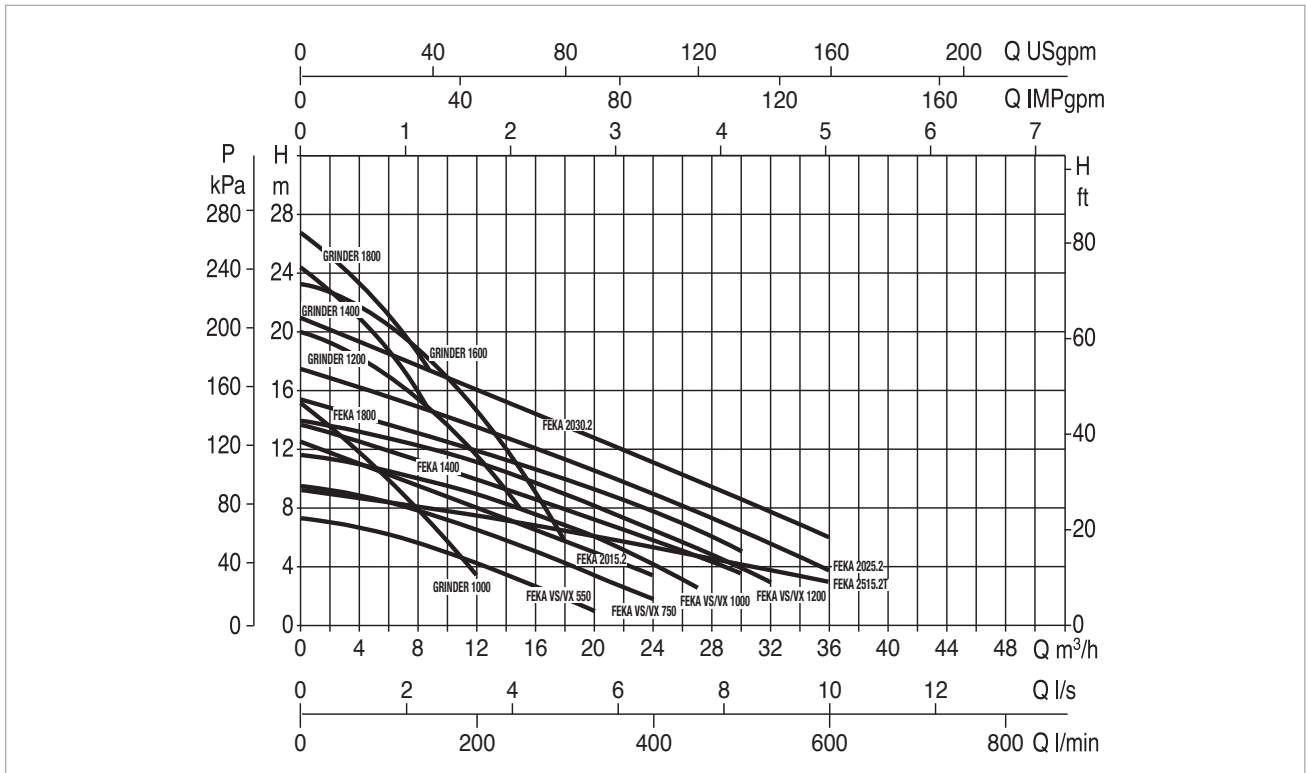

The performance curves are based on kinematic viscosity values = 1 mm²/s and density equal to 1000 kg/m³. Tolerance of the curves according to ISO9906.

DN50 CONFIGURATIONS

MODEL PUMP	ELECTRICAL DATA					PANEL COMBINATION		
	POWER SUPPLY 50 HZ	P1 MAX kW	P2 RATED		In A	E2D	E.BOX BASIC / E.BOX BASIC D	E.BOX PLUS / E.BOX PLUS D
			kW	HP				
FEKA VS/VX 550 M-NA	1X220 - 240 V~	0.9	0.55	0.75	4.2	E2D 2 M	•	•
FEKA VS/VX 550 T-NA	3X400 V~	0.9	0.55	0.75	1.64	E2D 2 T		•
FEKA VS/VX 750 M-NA	1X220 - 240 V~	1.1	0.75	1	5.13	E2D 2 M	•	•
FEKA VS/VX 750 T-NA	3X400 V~	1.1	0.75	1	1.94	E2D 2 T		•
FEKA VS/VX 1000 M-NA	1X220 - 240 V~	1.4	1	1.36	6.63	E2D 3 M	•	•
FEKA VS/VX 1000 T-NA	3X400 V~	1.4	1	1.36	2.51	E2D 3 T		•
FEKA VS/VX 1200 M-NA	1X220 - 240 V~	1.9	1.2	1.6	8.63	E2D 3 M	•	•
FEKA VS/VX 1200 T-NA	3X400 V~	1.9	1.2	1.6	3.44	E2D 3 T		•
FEKA 1400 M	1X220 - 240 V~	1.8	1.1	1.5	8.5	E2D 6 M 40 uF	•	•
FEKA 1800 T	3X400 V~	1.9	1.5	2.0	3.7	E2D 3 T		•
GRINDER 1400 M	1X220 - 240 V~	1.9	1.1	1.5	8.7	E2D 6 M HS	•	
GRINDER 1800 T	3X400 V~	2	1.5	2.0	3.8	E2D 3 T		•
GRINDER 1000 M-NA	1X220 - 240 V~	1.5	1	1.3	8	E2D 3 M	•	•
GRINDER 1000 T	3X400 V~	1.6	1	1.3	2.8	E2D 3 T		•
GRINDER 1200 M-NA	1X220 - 240 V~	2.8	1.5	2	12.7	E2D 4 M	•	•
GRINDER 1200 T	3X400 V~	2.7	1.5	2	4.7	E2D 5 T		•
GRINDER 1600 M-NA	1X220 - 240 V~	3.8	1.8	2.4	16.8	E2D 4.8 M	•	•
GRINDER 1600 T	3X400 V~	3.3	1.8	2.4	5.8	E2D 5 T		•
FEKA 2015.2 M-NA	1X220 - 240 V~	1.6	1.1	1.5	8	E2D 2.6 M	•	•
FEKA 2015.2 T-NA	3X400 V~	1.5	1.1	1.5	2.8	E2D 3 T		•
FEKA 2025.2 T-NA	3X400 V~	2.2	1.8	2.4	4.1	E2D 5 T		•
FEKA 2030.2 T-NA	3X400 V~	3.3	2.2	3	5.6	E2D 5 T		•

FEKAFOS MAXI 1200 – 1700 - 2200 - 3600

AUTOMATIC LIFTING STATIONS FOR THE COLLECTION AND LIFTING OF WASTE WATER

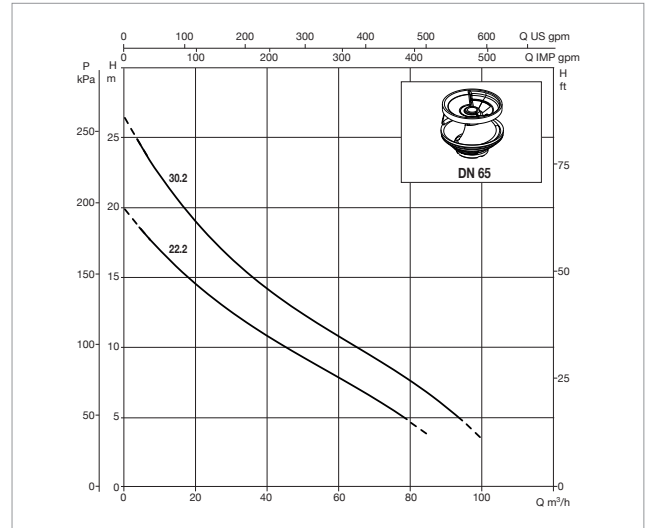
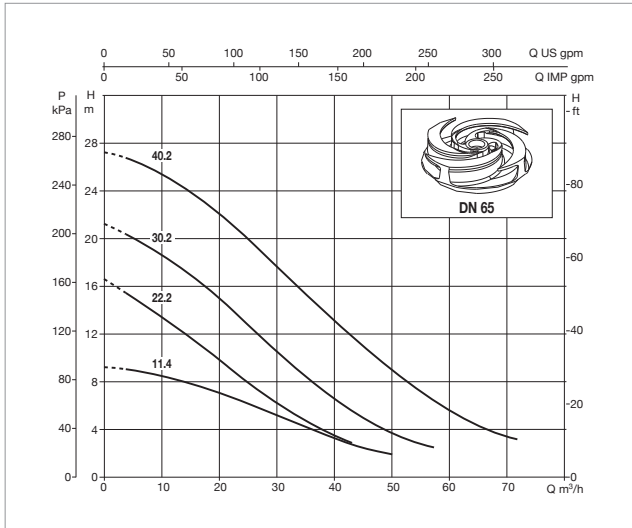

The performance curves are based on kinematic viscosity values = 1 mm²/s and density equal to 1000 kg/m³. Tolerance of the curves according to ISO9906.

DN65 CONFIGURATIONS

MODEL PUMP	ELECTRICAL DATA					PANEL COMBINATION		
	POWER SUPPLY 50 HZ	P1 MAX kW	P2 RATED		In A	E2D	E.BOX PLUS	E.BOX PLUS D
			kW	HP				
FKV 65 11.4 T5 400D	3 x 400V~	1.3	1.1	1.5	3.3	E2D 3 T	•	•
FKV 65 22.2 T5 400D	3 x 400V~	2.5	2.2	3.0	4.8	E2D 5 T	•	•
FKV 65 30.2 T5 400D	3 x 400V~	3.3	3.0	4.0	5.7	E2D 5 T	•	•
FKV 65 40.2 T5 400D	3 x 400V~	4.6	4.0	5.5	7.5	E2D 8 T	•	•
FKC 65 22.2 T5 400D	3 x 400V~	2.6	2.2	3.0	4.8	E2D 5 T	•	•
FKC 65 30.2 T5 400D	3 x 400V~	3.4	3.0	4.0	5.8	E2D 5 T	•	•

FEKAFOS MAXI 1200 – 1700 - 2200 - 3600

AUTOMATIC LIFTING STATIONS FOR THE COLLECTION AND LIFTING OF WASTE WATER

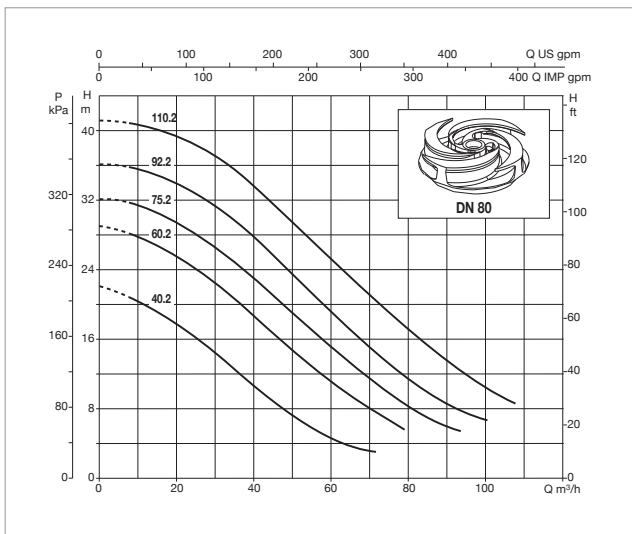
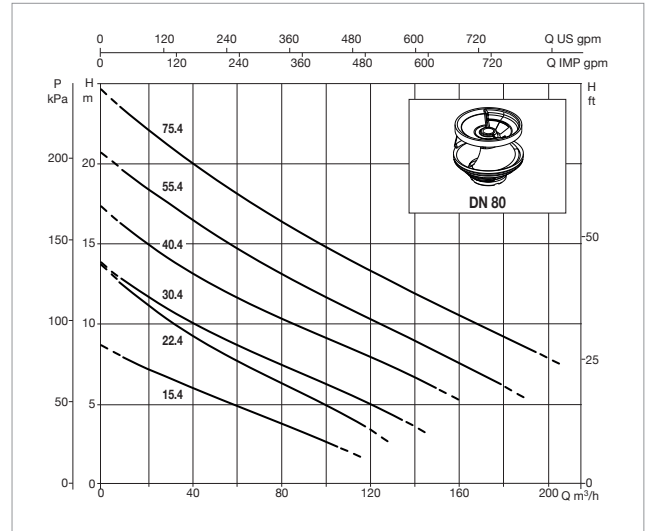
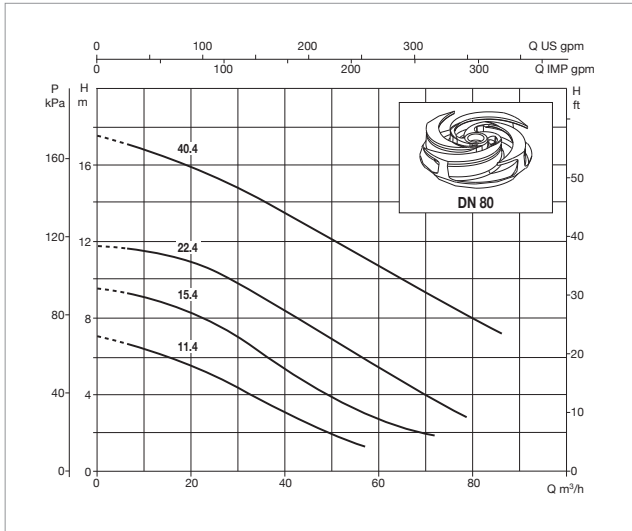

The performance curves are based on kinematic viscosity values = 1 mm²/s and density equal to 1000 kg/m³. Tolerance of the curves according to ISO9906.

DN80 CONFIGURATIONS

MODEL PUMP	ELECTRICAL DATA				PANEL COMBINATION			
	POWER SUPPLY 50 HZ	P1 MAX kW	P2 RATED kW HP		In A	E2D	E.BOX PLUS	E.BOX PLUS D
FKV 80 11.4 T5 400D	3 x 400 V~	1.3	1.1	1.5	3.5	E2D 3 T	•	•
FKV 80 15.4 T5 400D	3 x 400 V~	1.8	1.5	2.0	3.8	E2D 3 T	•	•
FKV 80 22.4 T5 400D	3 x 400 V~	2.5	2.2	3.0	4.7	E2D 5 T	•	•
FKV 80 40.4 T5 400D	3 x 400 V~	4.5	4.0	5.5	8.6	E2D 8 T	•	•
FKV 80 40.2 T5 400D	3 x 400 V~	4.6	4.0	5.5	7.7	E2D 8 T	•	•
FKV 80 60.2 T5 400Y/D	3 x 400 V~	6.9	6.0	8.2	11.7	E2D 15 T SD		
FKV 80 75.2 T5 400Y/D	3 x 400 V~	8.3	7.5	10.2	13.7	E2D 15 T SD		
FKV 80 92.2 T5 400Y/D	3 x 400 V~	10.2	9.2	12.5	18.0	E2D 30 T SD		
FKV 80 110.2 T5 400Y/D	3 x 400 V~	12.1	11.0	15.0	21.0	E2D 30 T SD		
FKC 80 15.4 T5 400D	3 x 400 V~	1.8	1.5	2.0	3.5	E2D 3 T	•	•
FKC 80 22.4 T5 400D	3 x 400 V~	2.6	2.2	3.0	4.7	E2D 5 T	•	•
FKC 80 30.4 T5 400D	3 x 400 V~	3.6	3.0	4.0	7.6	E2D 8 T	•	•
FKC 80 40.4 T5 400D	3 x 400 V~	4.7	4.0	5.5	8.9	E2D 8 T	•	•
FKC 80 55.4 T5 400Y/D	3 x 400 V~	6.3	5.5	7.5	8.6	E2D 15 T SD		
FKC 80 75.4 T5 400Y/D	3 x 400 V~	8.1	7.5	10.0	14.1	E2D 30 T SD		

FEKAFOS MAXI 1200 – 1700 - 2200 - 3600

AUTOMATIC LIFTING STATIONS FOR THE COLLECTION AND LIFTING OF WASTE WATER

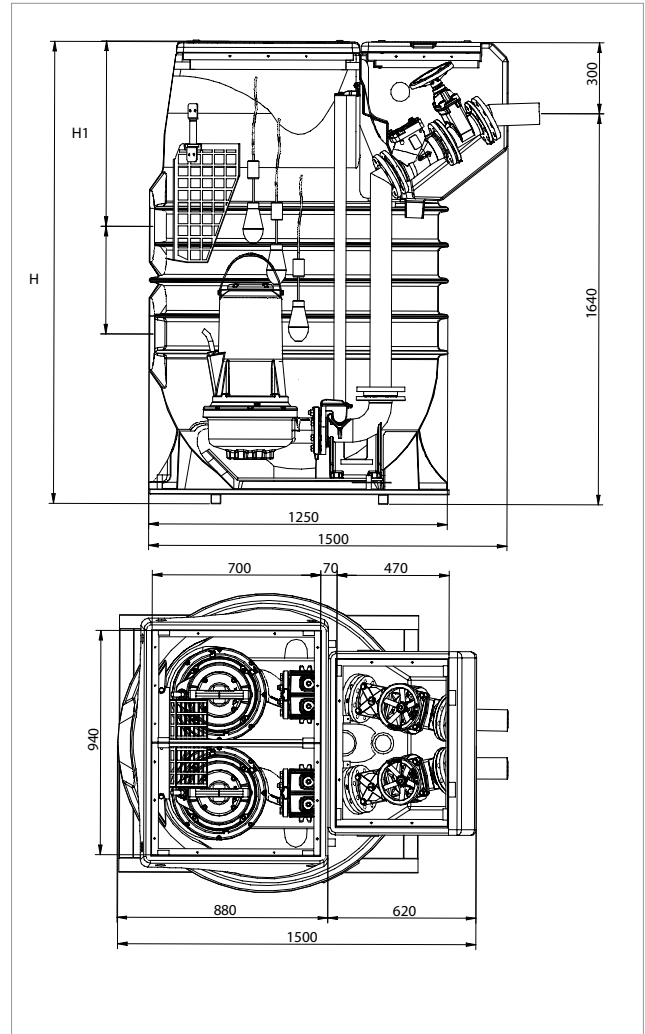
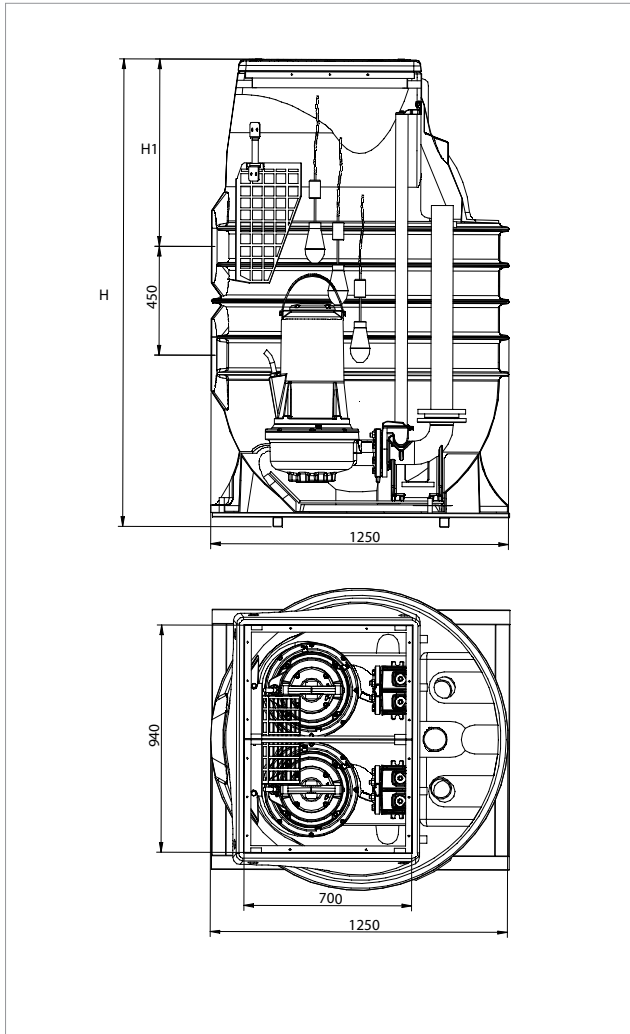

DIMENSIONS AND WEIGHTS

MODEL	VOLUME (L)	INLET / OUTLET	H1 (mm)	LIVE STORAGE CAPACITY (L)	H (mm)	WEIGHT kg	DIMENSIONS (mm)	DIMENSIONS WITH VALVE SECTION (mm)
FEKAFOS 1200 MAXI	1200	125 / 2x DN60	775	800	1420	140	1250 x 1250 x 1420	1250 x 1500 x 1420
FEKAFOS 1700 MAXI	1700		775	1050	1870	165	1250 x 1250 x 1870	1250 x 1500 x 1870
FEKAFOS 2200 MAXI	2200		775	1900	2320	190	1250 x 1250 x 2320	1250 x 1500 x 2320
FEKAFOS 3600 MAXI	3600		775	3100	3670	285	1250 x 1250 x 3670	1250 x 1500 x 3670
FEKAFOS 1200 MAXI	1200	160 / 2x DN65	775	800	1420	170	1250 x 1250 x 1420	1250 x 1500 x 1420
FEKAFOS 1700 MAXI	1700		775	1050	1870	195	1250 x 1250 x 1870	1250 x 1500 x 1870
FEKAFOS 2200 MAXI	2200		775	1900	2320	220	1250 x 1250 x 2320	1250 x 1500 x 2320
FEKAFOS 3600 MAXI	3600		775	3100	3670	315	1250 x 1250 x 3670	1250 x 1500 x 3670
FEKAFOS 1200 MAXI	1200	160 / 2x DN80	775	800	1420	183	1250 x 1250 x 1420	1250 x 1500 x 1420
FEKAFOS 1700 MAXI	1700		775	1050	1870	208	1250 x 1250 x 1870	1250 x 1500 x 1870
FEKAFOS 2200 MAXI	2200		775	1900	2320	220	1250 x 1250 x 2320	1250 x 1500 x 2320
FEKAFOS 3600 MAXI	3600		775	3100	3670	328	1250 x 1250 x 3670	1250 x 1500 x 3670

H1* The entry measurement from the ground level can be modulated, on request it is possible to have a greater amount defined in the following intervals.

FEKAFOS 1700 H1 optional: 1230 mm FEKAFOS 2200 H1 optional: 1230 mm / 1680 mm

FEKAFOS 3600 H1 optional: 1230 mm / 1680 mm / 2130mm / 2580mm

ACCESSORIES

ACCESSORIES

AUTOMATIC LIFTING STATIONS

D400 DRIVE-OVER FRAME	DESCRIPTION
	<p>D400 DRIVE-OVER FRAME To be fixed on site in the reinforced concrete structure surrounding the tank</p> <ul style="list-style-type: none"> - Steel frame for anchoring on the reinforced concrete slab. - Drive-over spheroidal cast iron manhole D400 1200x1200 - Elevation and protection skirt
VALVE SECTION	DESCRIPTION
	<p>VALVE SECTION Preassembled, to be ordered with the tank</p> <ul style="list-style-type: none"> - 2 spheroidal cast iron ball check valves - 2 spheroidal cast iron gate valves - 2 PE outlet pipes
FILTER BASKET	DESCRIPTION
	<p>FILTER BASKET: Preassembled, to be ordered with the tank</p> <p>Removable stainless steel basket with inlet filter grilles 40x40 mm.</p>
ANTI-INTRUSION GRATING	DESCRIPTION
	<p>ANTI-INTRUSION GRATING: Preassembled, to be ordered with the tank</p> <p>Steel frame and grilles for the protection of the upper access to the tank.</p>

ACCESSORIES

AUTOMATIC LIFTING STATIONS

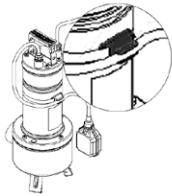

FLOATS	DESCRIPTION		WEIGHT Kg
	BULB FLOAT	10 metres	1.3
		20 metres	2
	FLOAT CABLE CLAMP KIT FEKA VS/VX		0.12

CONTROL AND ALARMS	DESCRIPTION	WEIGHT Kg
	CONTROL AS 1 – WITH ALARM DEVICE	2

BRACKET	DESCRIPTION	WEIGHT Kg
	ANTI-ROTATION BRACKET FOR FEKA VS - VX	0.3

ACCESSORIES

AUTOMATIC LIFTING STATIONS

BALL CHECK VALVES	DESCRIPTION	WEIGHT Kg
	2" THREADED PVC BALL CHECK VALVE	0.8
	2" THREADED BALL CHECK VALVE	6
	DN50 BALL CHECK VALVE	9.5
	DN65 BALL CHECK VALVE	9.5
	DN80 BALL CHECK VALVE	16
	DN 50 FLAT BODY GATE VALVE	11.2
	DN 65 FLAT BODY GATE VALVE	14.9
	DN 80 FLAT BODY GATE VALVE	16.7

FEKAFOS MAXI 1200-3600 PUMPING STATION POSITIONING

Underground on the outside of a building, make a reinforced concrete support platform of adequate strength, calculated by a qualified technician. Position the tank on top of the reinforced concrete support platform and make holes in it in correspondence with the appropriate hooking seats made on the base of the product. Then insert pressure screws into the holes made and hook the tank.

In order to avoid abnormal deformations on the tanks and on the inspection towers during the backfill, always keep the water level inside the tank higher than the level of backfill. Proceed forming layers of 15/20 cm, filling the water tank first and then backfilling with light concrete, as indicated in the drawing.

Finally, cover the product with a layer of washed round gravel and sand until it is completely covered.

In the event of groundwater, having made the reinforced concrete slab, fill the tank with water until reaching the groundwater level, externally backfilling it for the same thickness with concrete.

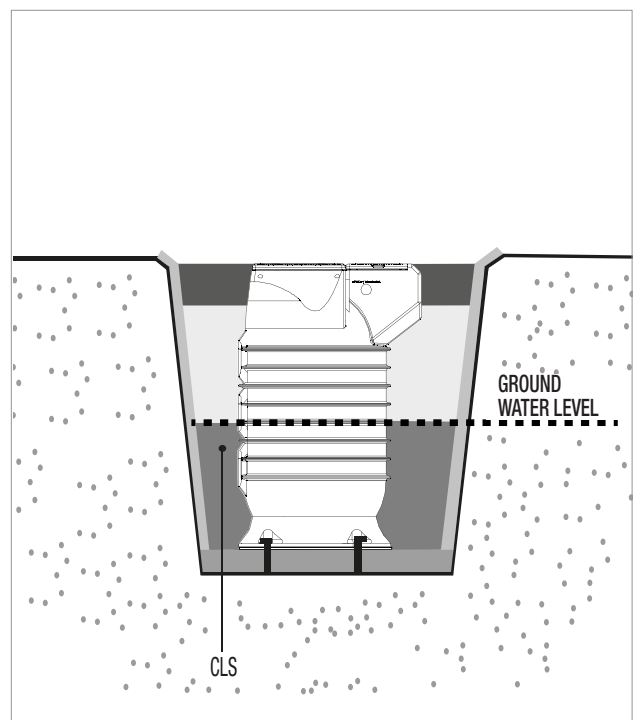
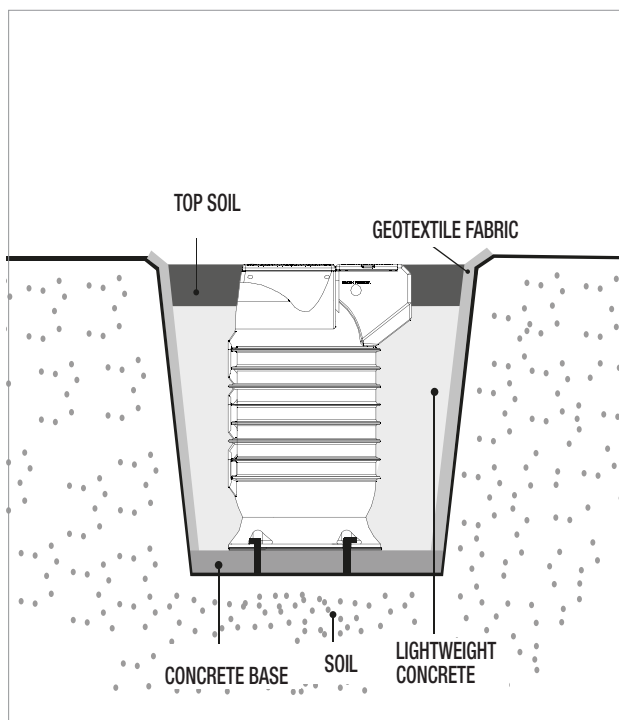

DNA[®]
PUMPS SELECTOR



On-line selection of products



DAB PUMPS LTD.

Unit 4 and 5, Stortford Hall Industrial Park,
Dunmow Road,
Bishops Stortford,
Herts
CM23 5GZ - UK
salesuk@dwgroup.com
Tel. +44 1279 652 776
Fax +44 1279 657 727



DAB PUMPS IBERICA S.L.

Calle Verano 18-20-22
28850 - Torrejón de Ardoz - Madrid
Spain
Info.spain@dwgroup.com
Tel. +34 91 6569545
Fax: + 34 91 6569676



DAB PUMPS SOUTH AFRICA

Twenty One industrial Estate,
16 Purlin Street, Unit B, Warehouse 4
Olifantsfontein -1666 - South Africa
info.sa@dwgroup.com
Tel. +27 12 361 3997



DAB PUMPS B.V.

Brusselstraat 150
B-1702 Groot-Bijgaarden - Belgium
info.belgium@dwgroup.com
Tel. +32 2 4668353
Fax +32 2 4669218



DAB PUMPS HUNGARY KFT.

H-8800
Nagykanizsa, Buda Ernő u.5
Hungary
Tel. +36 93501700



DAB PUMPS (QINGDAO) CO. LTD.

No.40 Kaituo Road, Qingdao Economic & Technological
Development Zone
Qingdao City, Shandong Province - China
PC: 266500
sales.cn@dwgroup.com
Tel. +86 400 186 8280
Fax +86 53286812210



DAB PUMPS POLAND Sp. z o.o.

Ul. Janka Muzykanta 60
02-188 Warszawa - Poland
polska@dabpumps.com.pl



DAB PUMPS B.V.

Albert Einsteinweg, 4
5151 DL Drunen - Nederland
info.netherlands@dwgroup.com
Tel. +31 416 387280
Fax +31 416 387299



OOO DAB PUMPS

Novgorodskaya str. 1, block G
office 308, 127247, Moscow - Russia
info.russia@dwgroup.com
Tel. +7 495 122 0035
Fax +7 495 122 0036



DAB PUMPS DE MÉXICO, S.A. DE C.V.

Av Amsterdam 101 Local 4
Col. Hipódromo Condesa,
Del. Cuauhtémoc CP 06170
Ciudad de México
Tel. +52 55 6719 0493



DAB PUMPEN DEUTSCHLAND GmbH

Tackweg 11
D - 47918 Tönisvorst - Germany
info.germany@dwgroup.com
Tel. +49 2151 82136-0
Fax +49 2151 82136-36



DAB PUMPS INC.

3226 Benchmark Drive
Ladson, SC 29456 - USA
info.usa@dwgroup.com
Tel. 1- 843-797-5002
Fax 1-843-797-3366



DAB PUMPS OCEANIA PTY LTD

426 South Gippsland Hwy,
Dandenong South VIC 3175 - Australia
info.oceania@dwgroup.com
Tel. +61 1300 373 677