

NEW RANGE

FX

WHEN THE GOING
GETS TOUGH...



DAB
WATER • TECHNOLOGY

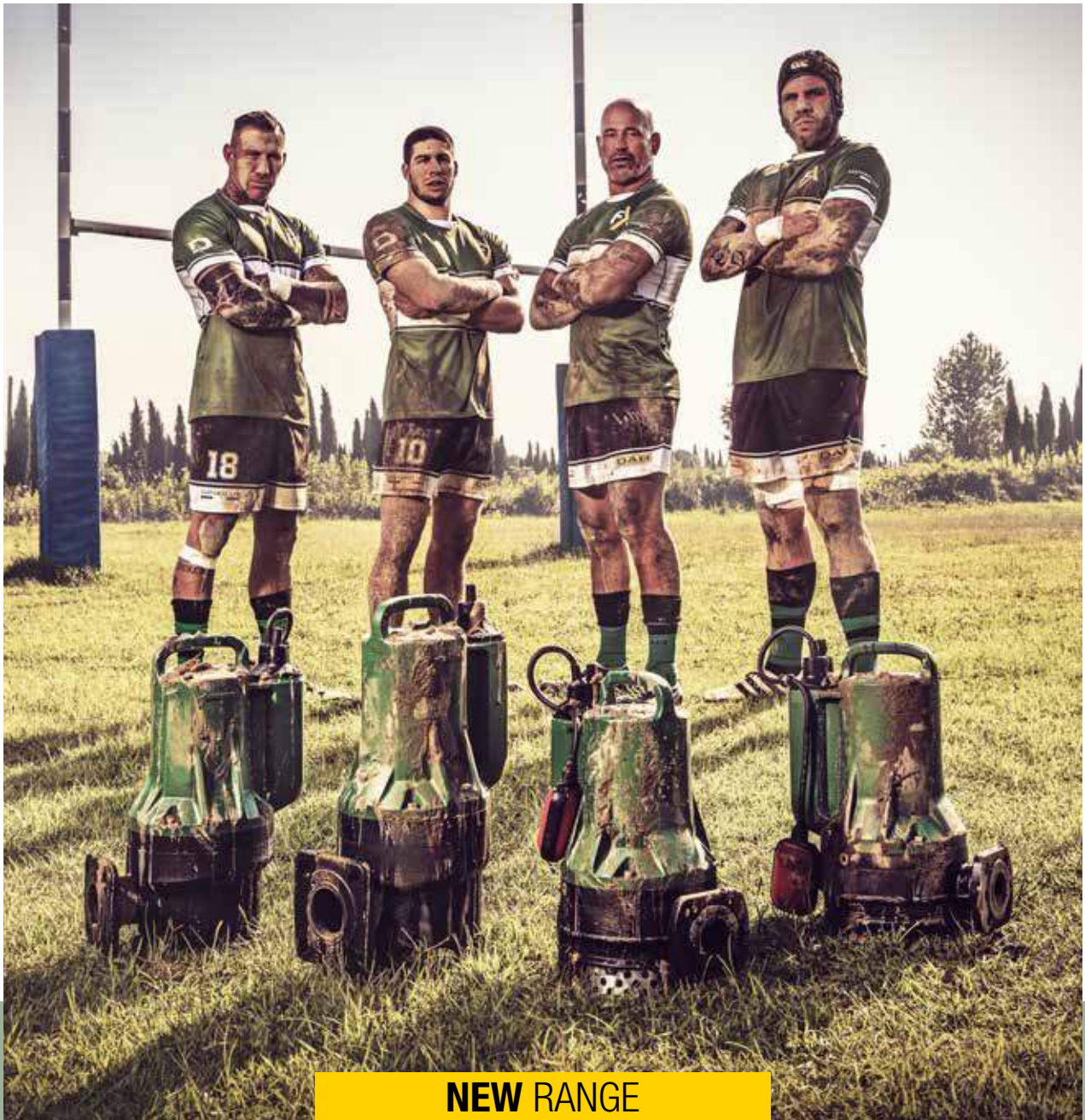

NEW RANGE



THE TEAM THAT ALWAYS SCORES.

Four completely innovative solutions for waste water; four answers to your needs.





**RESIDENTIAL
BUILDING
SERVICE**



**COMMERCIAL
BUILDING
SERVICE**



**INDUSTRIAL
SERVICE**

THE NEW **FX** LINE IS DESIGNED FOR LIFTING AND TRANSFER OF
DOMESTIC, CIVIL AND INDUSTRIAL WASTE WATER

- Suitable for pumping stations for lifting and transfer of sewage and drain water from residential or public buildings
- Suitable for the draining of car parks, garages, roads below ground level and environments prone to flooding.
- Suitable for the transfer of sewage water from industrial processes.



DRAINAGE WATER



EFFLUENT WATER



SEWAGE WATER



**THE NEW RANGE FOR
SPECIALISTS IN WASTE WATER**





A WIDE RANGE OF SOLUTIONS



DRENAG FX

Draining pumps with rubber coverings that limit wear due to the presence of sand or abrasive particles. **Suitable for draining environments prone to flooding where high head is necessary.**



GRINDER FX

Pumps with a high resistance stainless steel grinder system **suitable for the transfer of sewage water at high pressure or when narrow piping is needed to keep down system installation costs.**

Tested in the most complex scenarios that involve the draining of sewage water, the new FX range comprises **4 lines certified for waste water** according to standard EN 12050.



FEKA FXC

Pumps with anti-clogging channel impeller. **Suitable for drainage and the transfer of effluent and sewage water, containing solids up to 50mm with reduced long fibre content.**



FEKA FXV

Pump with patented super vortex impeller **increase performance without compromising the ability to work in the presence of large solids and long fibres, guaranteeing a completely free passage.**





A STRONGER AND ROBUST RANGE



ABSOLUTE RELIABILITY AND DURABILITY

Design was carried out with absolute reliability and strength in mind. The double silicon carbide mechanical seals are entirely enclosed in the oil chamber to avoid direct contact with the pumped liquid.

The high standards of construction, including the motor shaft in anti-corrosion stainless steel AISI 304, the external cataphoresis and two-component coating and the resin sealed cable gland, guarantee the long life of the range.

The new FX range also comes with new motors more compact than ever, sized to guarantee high resistance to clogging and consistent performance.

RELIABILITY AND SAFETY



GOOD PERFORMANCE AND COMPLIANCE

The pumps in the FX range meet the most stringent quality standards and are compliant with waste water standards **EN 12050**.

They are also available with **ATEX** certification



COMPACT MOTORS



DESIGNED TO INCREASE PERFORMANCE AND REDUCE RISKS

The new, compact motors are designed to increase the starting torque and reduce the risk of clogging. Now more efficient than ever, they allow the FX pumps to run even when not fully submerged to permit complete emptying of the tanks.



QUICK AND SIMPLE MAINTENANCE



SOLUTIONS FOR PUMPS' CARE

The pumps in the FX range have a structure with three levels for quick access to all the main components, greatly facilitating maintenance. The spare parts have also been unified and made universal for the entire range.



HIGH EFFICIENCY, DOUBLE THE SAVINGS



CFD ANALYSIS AND THE BENEFITS

The FX range tackles the issue of efficiency from every point of view.

Advanced research into computational fluid dynamic analysis (CFD) has allowed us to improve performance in terms of efficiency and increase the capacity to manage sewage water. The FX range comes with high energy efficient motors that permit lower power ratings, these guarantee the same performance as a more powerful pump.

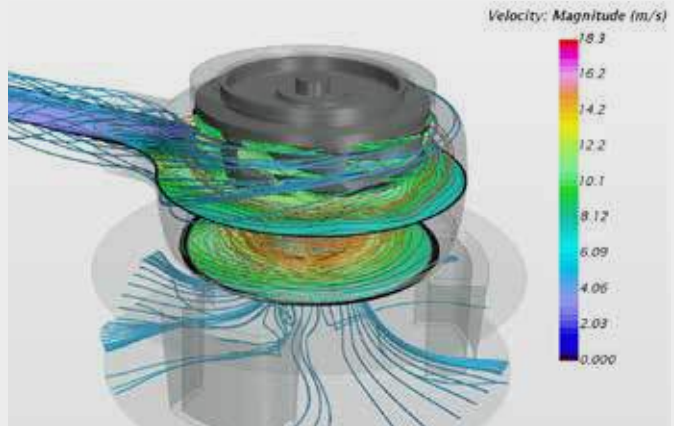

SUPER VORTEX, AN EXCLUSIVE DAB PATENT

GREAT NEWS. GREATER VALUE.



The new Super Vortex impeller, patented by DAB, is an important development. Completely redesigned on the basis of research into computational fluid dynamics, the new impeller improves on the performance of the FEKA FXV pumps under all conditions, reducing motor consumption while still offering the benefit of a free passage the same size as the pump's delivery port (50 and 65 mm).



GRINDER **FX**



DRENAG **FX**



FEKA **FXV**



FEKA **FXC**





A SAFE AND EASY PASSAGE

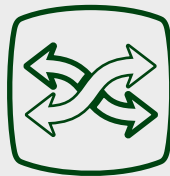

EASY TO INSTALL AND SUITABLE FOR REPLACEMENT

The new FX range is available with accessories to make the replacement of old models and system upgrades as easy as possible.

The reduced overall size, complete with threaded flange connection, makes installation even simpler.



AT YOUR SERVICE THROUGHOUT THE COUNTRY

A TEAM AT YOUR COMPLETE DISPOSAL

Thanks to its production capacity and our service network, DAB can guarantee the availability of the FX range throughout the whole of world.



SUBMERSIBLE PUMPS

MAIN CHARACTERISTICS



1 - Compact motors with high starting torques to reduce the clogging



2 - Double mechanical seal in the oil chamber complete protected from the pumped liquid



3 - Anti-leakage resin sealed cable gland with fast connections



4 - Delivery port both threaded and flanged to increase the flexibility of installation



5 - Condenser compartment easy to access for inspection and maintenance



6 - Anti-corrosion stainless steel motors shaft. AISI 304



7 - Cataphoresis and two-component coating to guarantee high resistance



8 - Rubber disc for increasing stability for the pump in mobile installations

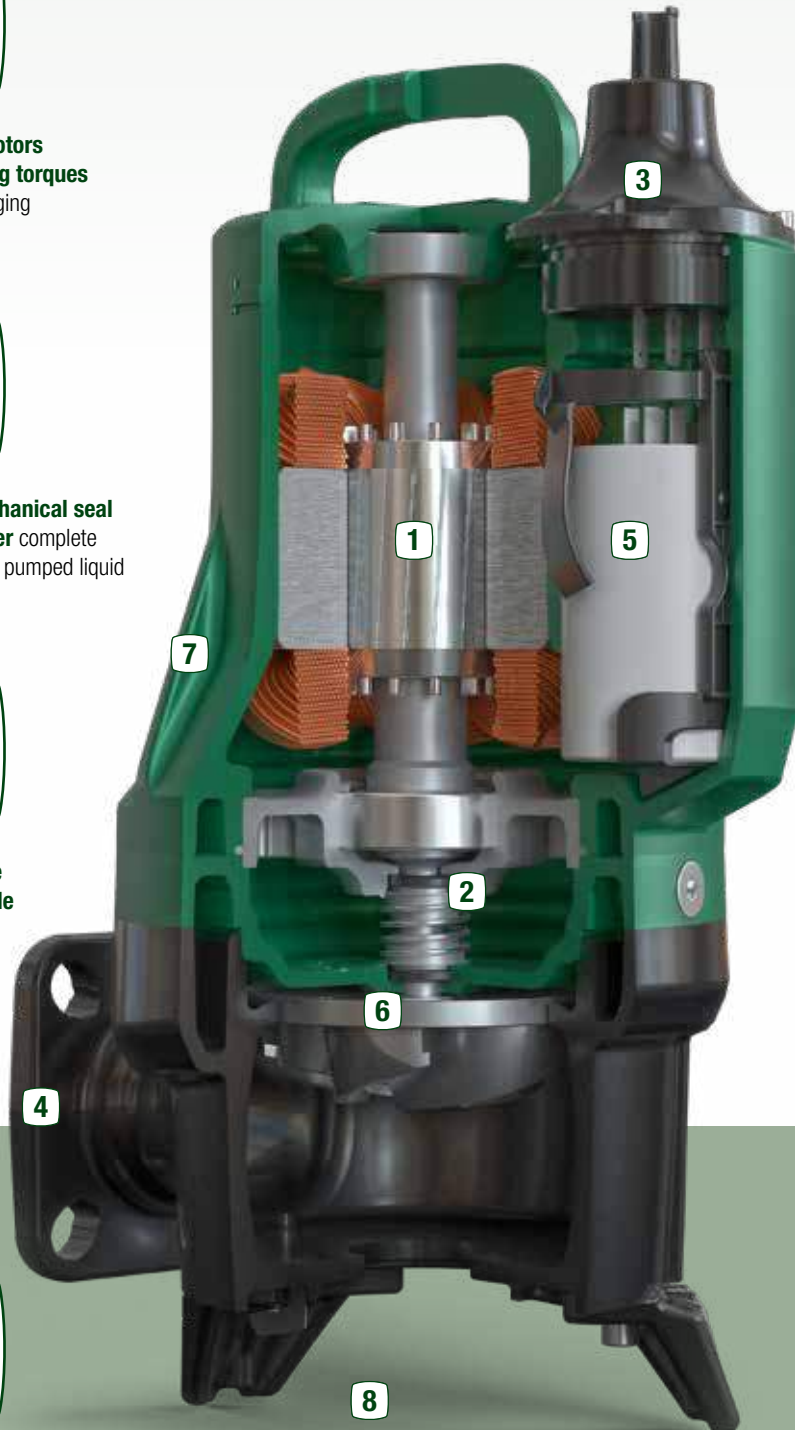

EXTENSIVE RANGE



HIGH PERFORMANCE

DAB is able to offer the most extensive range of submersible pumps on the market, with flow rates of up to 72 m³/h and heads up to 33 metres.

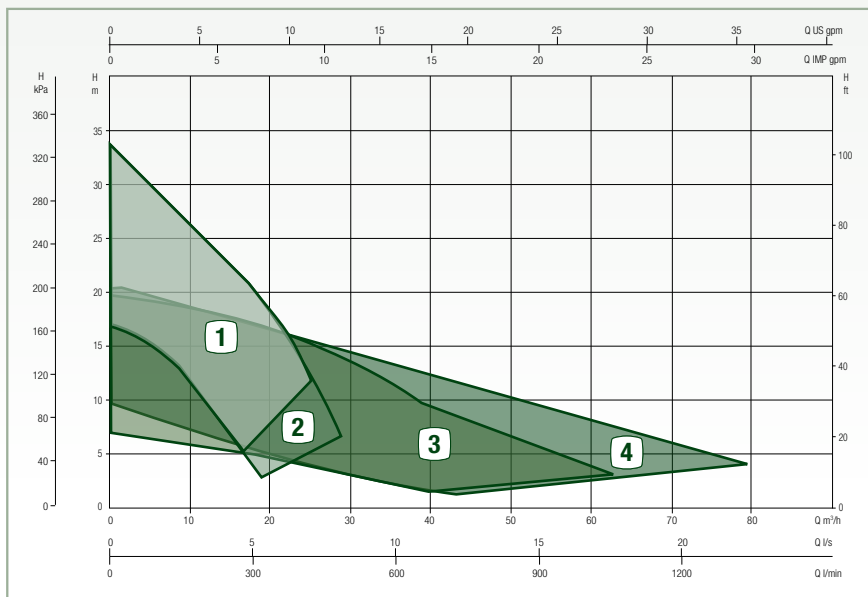

1 GRINDER FX

2 DRENAG FX

3 FEKA FXV

4 FEKA FXC

TECHNICAL DATA

MODEL	P2 [KW]	OUTLET	FREE PASSAGE	H MAX [m]	Q MAX [l/min]
FEKA FXV	0,7 - 2,2	2" /DN50 / DN65	50 – 65 mm	18,5	900
FEKA FXC	0,7 - 2,2	2" /DN50 / DN65	50 mm	19	1200
GRINDER FX	0,7 - 2,2	1" ½ /DN 32 /DN40	GRINDER	33	320
DRENAG FX	0,7 - 2,2	1" ½ /DN 32 /DN40	10 mm	32	510

ACCESSORIES

EBOX

Electronic control panel for automatic operation of one or two submersible pumps.



FLANGE FOR REPLACEMENT



90° ATTACHMENT



FEKABOX - FEKAFOS

Tanks for the collection and redirection to the sewer network of domestic waste water (sewage and draining water), for basements and garages, for one or more dwellings, when the sewer network cannot be reached due to gravity issues.



COUPLING FOOT



ebox

RELIABILITY AT YOUR COMMAND

ELECTRONIC CONTROL PANEL

ebox is an electronic control panel for automatic control and protection of one or more single or three phase submersible electric pumps or pressure booster pumps for domestic applications.

The ebox can be used to control an automatic lifting station for FX pumps, and is a **universal panel for the entire range**.



EBOX PLUS

Thanks to the configuration wizard, installation of the display version is much simpler.

Management of the FX pumps is also much easier, thanks to the status always being visible and to a range of additional functions, such as the anti-seizing of drainage pumps, the alarm log, the language selection, and the password protected settings.

EMPTYING/FILLING FUNCTION

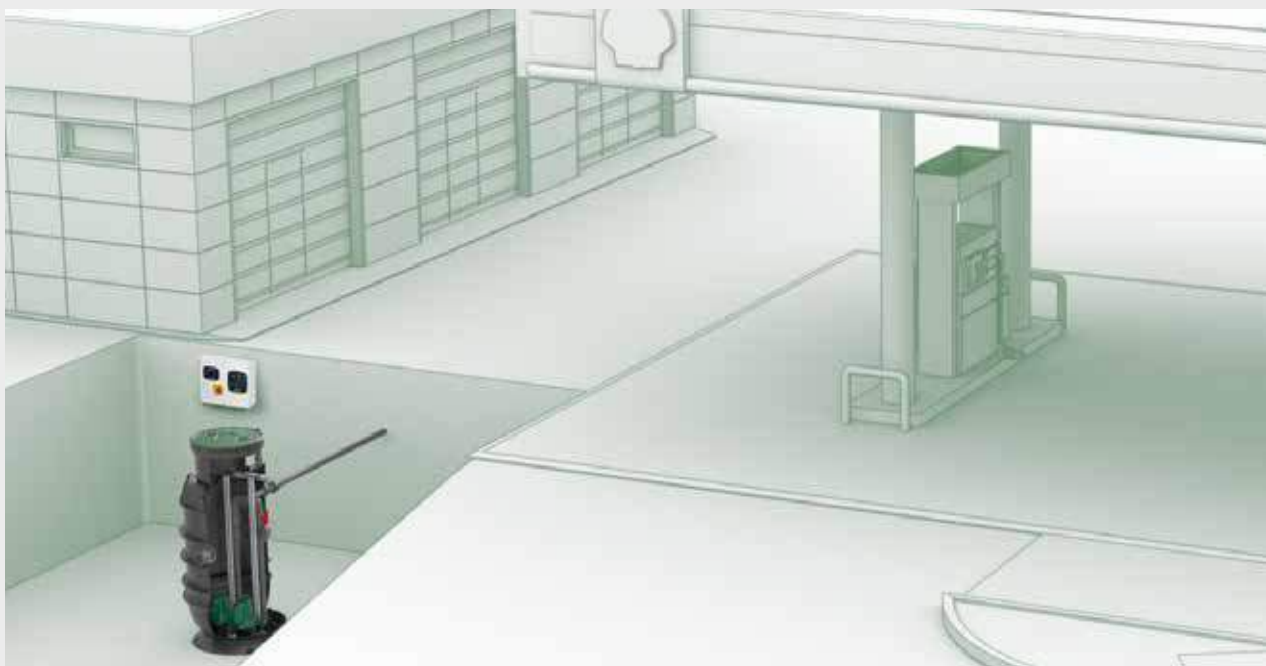

Ideal for controlling filling/emptying pumping stations used for draining both effluent and sewage water.



D + CONNECT + FX

INTERNET OF PUMPS IS ALREADY A REALITY

ALWAYS IN CONTACT WITH YOUR SYSTEMS

DConnect is the new DAB cloud service that allows you to remotely control your installations, in real time and wherever you are.

Connectivity in the cloud with DConnect allows you to monitor activity of the FX pumps and receive updates on operation and alarms in order to anticipate the risk of malfunctions and seizing.



DOWNLOAD THE APP FROM:



OPERATION DIAGRAM

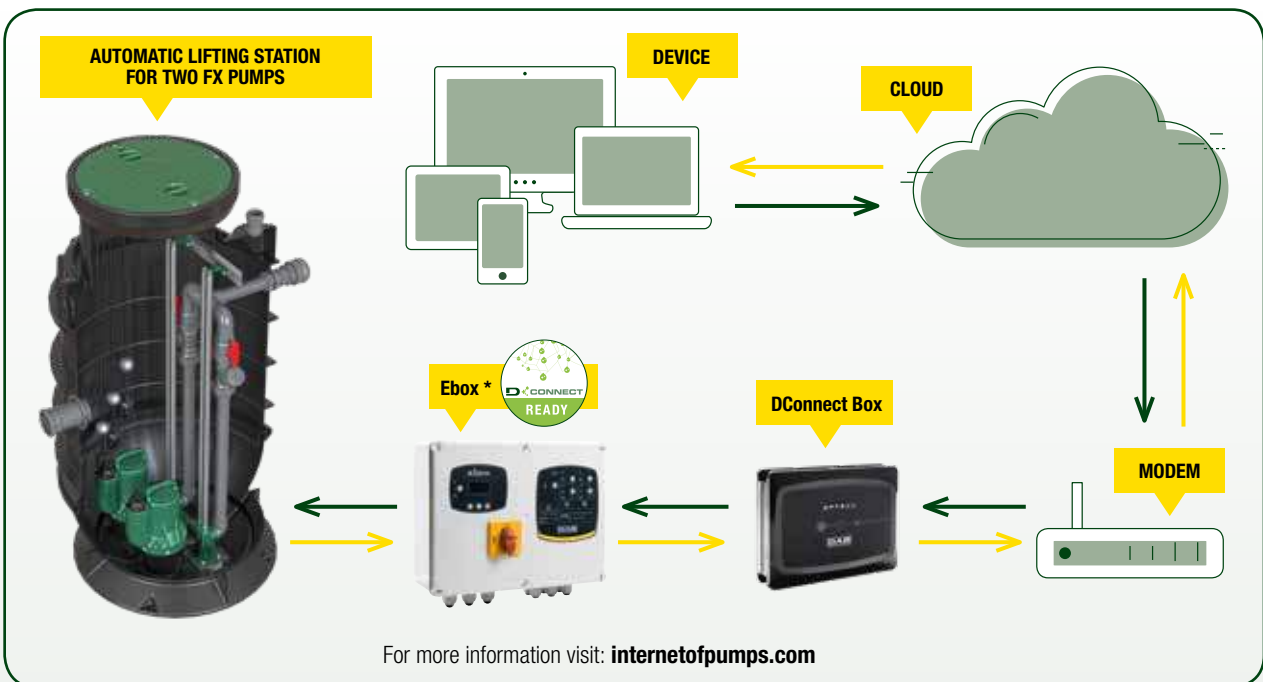

For more information visit: internetofpumps.com

* Only EBOX with the DConnect READY label are compatible with DConnect

**DAB PUMPS LTD.**

6 Gilberd Court
Newcomen Way
Severalls Business Park
Colchester
Essex
CO4 9WN - UK
salesuk@dwtgroup.com
Tel. +44 0333 777 5010

**DAB PUMPS IBERICA S.L.**

Calle Verano 18-20-22
28850 - Torrejón de Ardoz - Madrid
Spain
Info.spain@dwtgroup.com
Tel. +34 91 6569545
Fax: + 34 91 6569676

**DAB PUMPS SOUTH AFRICA**

Twenty One industrial Estate,
16 Purlin Street, Unit B, Warehouse 4
Olifantsfontein -1666 - South Africa
info.sa@dwtgroup.com
Tel. +27 12 361 3997

**DAB PUMPS BV**

'tHofveld 6 C1
1702 Groot Bijgaarden - Belgium
info.belgium@dwtgroup.com
Tel. +32 2 4668353

**DAB PUMPS HUNGARY KFT.**

H-8800
Nagykanizsa, Buda Ernő u.5
Hungary
Tel. +36 93501700

**DAB PUMPS (QINGDAO) CO. LTD.**

No.40 Kaituo Road, Qingdao Economic & Technological
Development Zone
Qingdao City, Shandong Province - China
PC: 266500
sales.cn@dwtgroup.com
Tel. +86 400 186 8280
Fax +86 53286812210

**DAB PUMPS B.V.**

Albert Einsteinweg, 4
5151 DL Drunen - Nederland
info.netherlands@dwtgroup.com
Tel. +31 416 387280
Fax +31 416 387299

**DAB PUMPS POLAND Sp. z o.o.**

Ul. Janka Muzykanta 60
02-188 Warszawa - Poland
polska@dabpumps.com.pl

**DAB PUMPS DE MÉXICO, S.A. DE C.V.**

Av Amsterdam 101 Local 4
Col. Hipódromo Condessa,
Del. Cuauhtémoc CP 06170
Ciudad de México
Tel. +52 55 6719 0493

**OOO DAB PUMPS**

Novgorodskaya str. 1, block G
office 308, 127247, Moscow - Russia
info.russia@dwtgroup.com
Tel. +7 495 122 0035
Fax +7 495 122 0036

**DAB PUMPEN DEUTSCHLAND GmbH**

Tackweg 11
D - 47918 Tönisvorst - Germany
info.germany@dwtgroup.com
Tel. +49 2151 82136-0
Fax +49 2151 82136-36

**DAB PUMPS INC.**

3226 Benchmark Drive
Ladson, SC 29456 - USA
info.usa@dwtgroup.com
Tel. 1- 843-797-5002
Fax 1-843-797-3366

**DAB PUMPS OCEANIA PTY LTD**

426 South Gippsland Hwy,
Dandenong South VIC 3175 - Australia
info.oceania@dwtgroup.com
Tel. +61 1300 373 677