

SWIMMING POOL PUMPS



DABPUMPS.COM



DAB[®]
WATER • TECHNOLOGY



1.700

DAB PEOPLE

338
MILLION €

TOTAL SALES

45

YEARS

14

SALES
AGENCIES

OVER
2,5
MILLION

PIECES
PRODUCED

Data updated at the beginning of 2021

Technological integration, design and passion: this is DAB.

To combine over 40 years of business tradition with the technological evolution that the sector of handling and water management requires, is the goal that DAB has settled on bringing forth an ambitious and challenging project.

A commitment that has borne fruit and a result, that today's, was created by combining all the forces that make up DAB, from its people to its clients.

With several acquisitions in recent years, DAB has reached the goal of being identified as a unique partner in the market of electronic

pumps, motors for submerged pumps and electronic solutions for pumping systems.

The ability to count, internally, on the different technologies means, not only greater agility of the production facilities, but also for better control of the products themselves.

The secret of lasting success is the ability to shape oneself according to the changes in the market, to always be ready to grasp opportunity, anticipate their demands and to be a source of innovative ideas.



think global, act local

DAB is present in many countries; production capacity and capillary distribution worldwide allow extreme effectiveness and timelessness in the processing of orders. The consequence of coordinated and optimized processes

allows us to guarantee the same performance and results anywhere in the world.

This allows DAB to provide a timely 360° service, providing constant support before and after sales while always maintaining the same level of quality.



6 PRODUCTION PLANTS

4 PLANTS DAB ITALY
DAB HUNGARY
DAB CHINA

14 SALES OFFICES

DAB UK	DAB POLAND
DAB GERMANY	DAB USA
DAB NETHERLANDS	DAB MEXICO
DAB BELGIUM	DAB CHINA
DAB SPAIN	DAB OCEANIA (Melbourne)
DAB RUSSIA	DAB INDONESIA
DAB SOUTH AFRICA	DAB UNITED ARAB EMIRATES

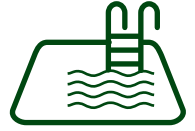

Eswim is DAB's high energy efficiency electronic swimming pool pump. Born for domestic and residential building service, it is also suitable for fish environments, in agriculture or for the industrial sector and treats chlorine and salt water.

Energy saving, silence and comfort.

The high efficiency of the permanent magnet motor is accompanied by the water cooling system which guarantees its silence; the hydraulics are optimized to reduce pressure drops and the eight speeds allow to optimize energy consumption; the intuitive display, the programming menu and the integrated diagnostics guarantee ease of use; its compact shape and variable speed operation make ESwim a versatile product, which can be used in all types of swimming pools.

Eswim is the swimming pool pump for those who seek quiet operation, energy savings and efficiency.



ePro

Version with two knobs opening system.

ENERGY SAVING

- HIGH EFFICIENCY PERMANENT MAGNET SYNCHRONOUS MOTOR
- HYDRAULICS OPTIMIZED FOR LOAD LOSS REDUCTION
- 8 TIMER PROGRAMMABLE SPEEDS

COMFORT

- SILENT OPERATION (WATER-COOLED MOTOR)
- COMPACT AND WITHOUT VIBRATIONS (NO COOLING FAN)
- PUMP PROTECTION BUILT-IN DIAGNOSTIC

VERSATILE

- VARIABLE FLOW AND SPEED OPERATION
- SIMPLE AND INTUITIVE BUILT-IN DISPLAY PROGRAMMING
- POSSIBILITY OF CABLE CONNECTION TO AN EXTERNAL CONTROLLER

TECHNICAL SPECIFICATIONS

	P1 MAX	Q MAX	H MAX	DIMENSIONS
ESWIM 150	1250 W	30 m³/h	16 m	550x300x316 mm
ESWIM 300	2250 W	42.5 m³/h	26 m	574x304x354 mm

OVERVIEW

ENERGY SAVING

The new Eswim is the best solution to reduce energy consumption. A traditional single-speed pool pump consumes as much as 7 refrigerators, which means that it indirectly produces about 1,380,000 grams of CO_2 , which is equivalent to what 138 trees would produce. Eswim really makes your system more efficient and optimizes electricity costs.

It guarantees energy savings of up to 90% thanks to the combination of:

- Synchronous permanent magnet motor
- High efficient hydraulics to reduce pressure losses
- 8 settable speeds.

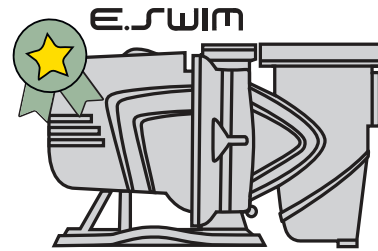

EXAMPLE WITH 3 CYCLES PER DAY, 10 HOURS A DAY AND 200 DAYS OF OPERATION PER YEAR

POOL SIZE	TRADITIONAL PUMP MODEL	ESWIM	ENERGY COST €/kWh	E.SWIM SAVING		
				1 DAY	1 YEAR	5 YEARS
30 m ³	0.5 Hp	ESWIM 150	0.12	€ 0.39	€ 78.62	€ 393.10
			0.24	€ 0.79	€ 157.24	€ 786.19
45 m ³	0.75 Hp	ESWIM 150	0.12	€ 0.72	€ 143.88	€ 719.42
			0.24	€ 1.44	€ 287.77	€ 1,438.83
60 m ³	1 Hp	ESWIM 150	0.12	€ 0.89	€ 177.00	€ 885.00
			0.24	€ 1.77	€ 354.00	€ 1,770.00
70 m ³	1.5 Hp	ESWIM 300	0.12	€ 1.64	€ 328.40	€ 1,641.99
			0.24	€ 3.28	€ 656.80	€ 3,283.99
90 m ³	2 Hp	ESWIM 300	0.12	€ 1.62	€ 323.49	€ 1,617.43
			0.24	€ 3.23	€ 646.97	€ 3,234.87
110 m ³	3 Hp	ESWIM 300	0.12	€ 2.68	€ 535.98	€ 2,679.89
			0.24	€ 5.36	€ 1,071.96	€ 5,359.78

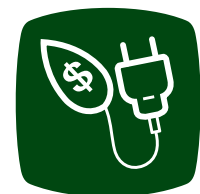

**AT LOWER SPEEDS
90% ENERGY
SAVING
COMPARED TO A
TRADITIONAL PUMP**

DID YOU KNOW THAT...

- The variation of the flow is proportional to the variation in the number of revolutions.
- The pressure variation follows a quadratic law in relation to the variation of the number of revolutions.
- The power follows a cubic law in relation to the variation of the number of revolutions.

A small variation in speed corresponds to a huge variation in power.

For example: I reduce the speed by 50% = I reduce by 8 times the power absorbed by the pump.

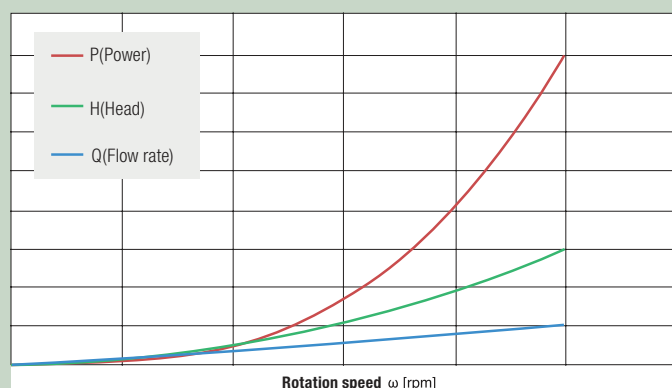

OVERVIEW

LOW NOISE

NO VIBRATIONS

Extreme silent running, thanks to the water cooled technology. No vibration, no cooling fan, anti vibration feet. The special water cooled motor, the inverter and the anti vibration feet make e.swim the most silent swimming pool pumps on the market.

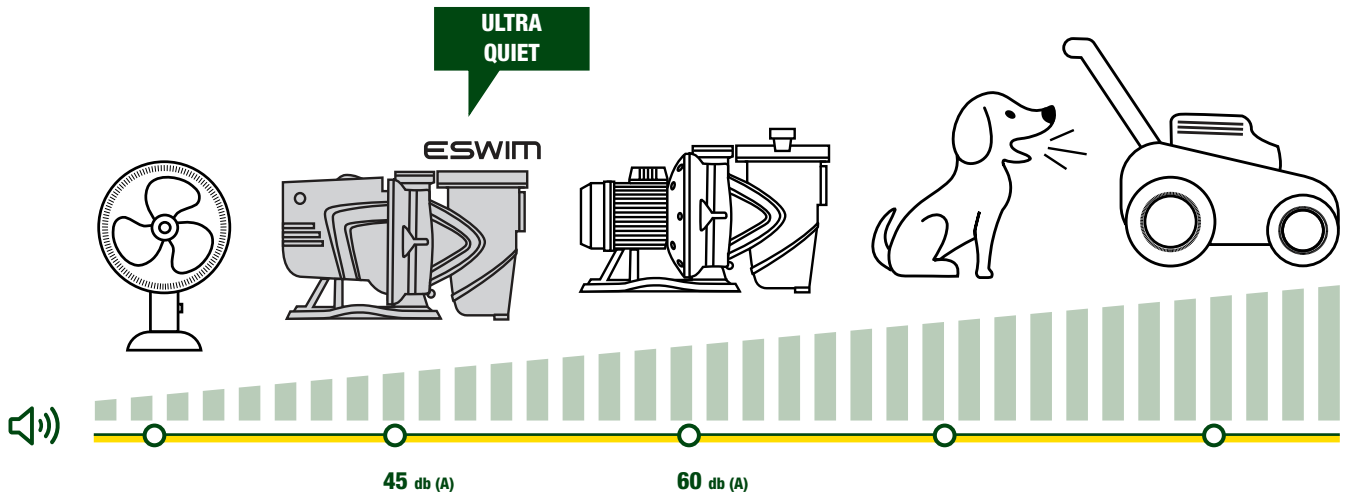

MINIMUM SPACE REQUIREMENT

MAX COMPACTNESS

suitable for installation in any place, even in the absence of air recirculation. It occupies 30% less space than any other conventional system.

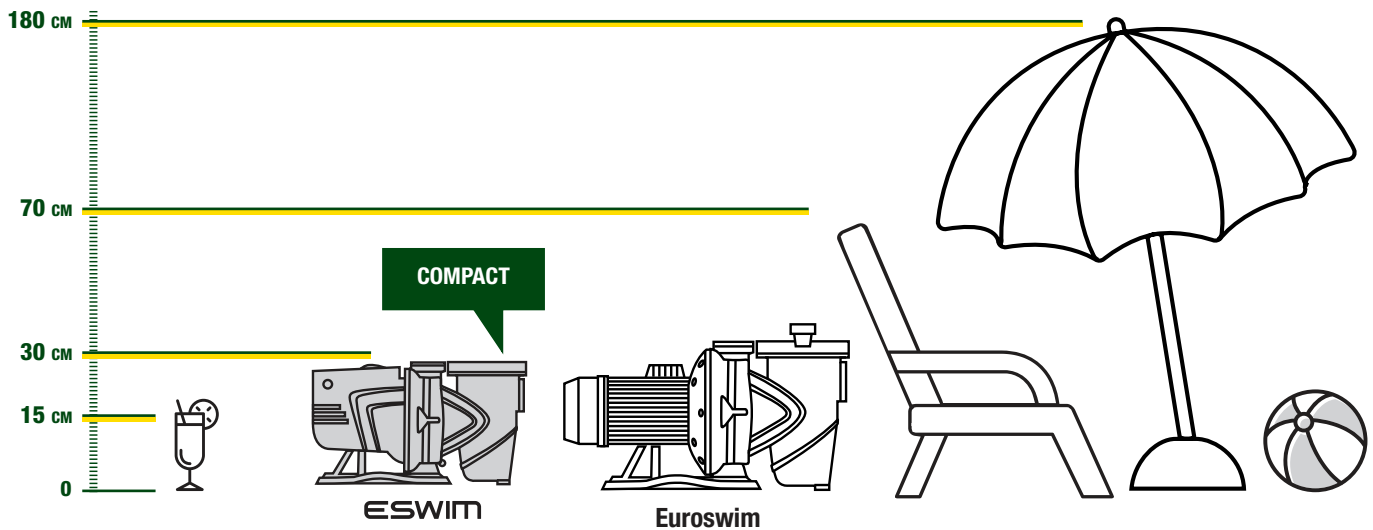

OVERVIEW

SAFETY FIRST

We think about your safety. ESwim is equipped with the SVRS (Safety Vacuum Release System) software which disables the suction capacity of the pump in the event that any foreign body becomes trapped in it in order to immediately stop the suction.



EASY INSTALLATION

The specific software allows to operate not only at different speeds, but also at variable or constant flow rates, thus guaranteeing a unique use experience.

LCD 70X40 mm high-resolution screen. The intuitive interface gives access to all the system information and the main settings depending on the specific application.

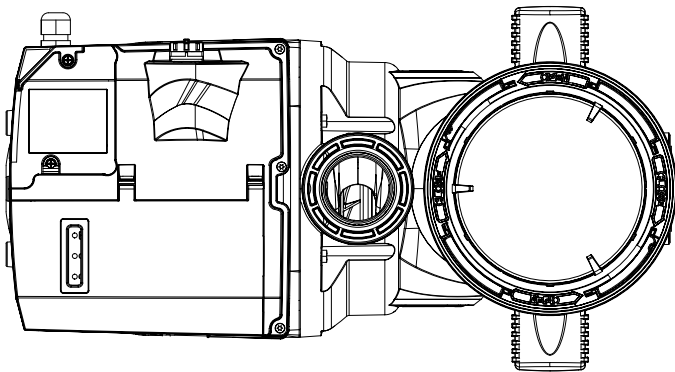
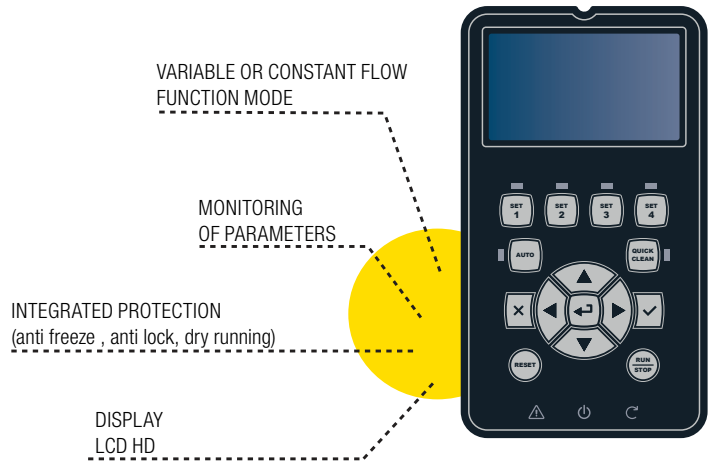

VERSATILITY

Wide choice and flexibility of use, manual or automatic operation, integrated control menu or connection from external control unit

MANUAL



Set point pre-set with unlimited time or configurable with specified time. Editable via panel.

AUTO

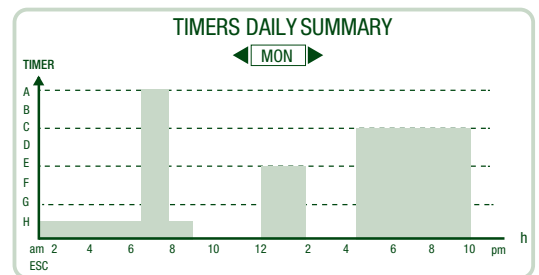

Auto operation with daily and weekly timer scheduling of different speeds.

Possibility to control the pump from REMOTE via digital or analogue contact (4-20mA / 0-10V)



FEATURES



DESIGN

This innovative solution combines aesthetics with sturdy materials highly resistant to corrosion and oxidation.



INTEGRATED PREFILTER

It has a large canister, up to 5 liters, a transparent lid that can be removed without tools, and an internal filter easy to take out and clean.



SUITABLE FOR
SALT WATER

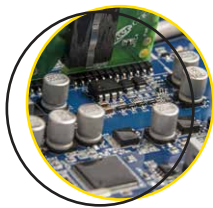

VARIABLE SPEED / FLOW CONTROL

The inverter control board allows operation at variable speed or flow rate, optimising performance and reducing consumption without the need for sensors.

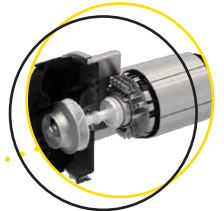

SYNCHRONOUS MOTOR WITH PERMANENT MAGNETS

The new synchronous motor with permanent magnets represents a new benchmark on the market due to its efficiency and reliability.



HIGH EFFICIENCY HYDRAULICS

The impeller and volute are designed specifically to improve/optimize hydraulic performance.

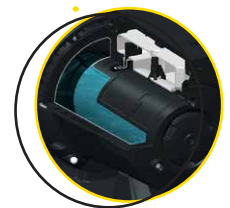

WATER COOLING

Motor cooled by the pumped water, free from fan cooling. It gains in compactness and low noise.



ANTI-VIBRATION FEET

The supporting base guarantees stability with integrated rubber feet that reduce vibrations.



USER INTERFACE PANEL

Intuitive interface panel for immediate control of the pump and programming according to any needs. High resolution LCD display.



ESWIM

DAB AND SWIMMING POOLS

DAB's pumps for swimming pools are developed to guarantee reliability, efficiency and ease of maintenance, and designed to offer added value for the installer and considerable savings, as well as comfort for the end user.

The pumps are suitable for all types of application, from small residential swimming pools to public swimming pools.



Euroswim

HIGH RELIABILITY



Self-priming pump to be used in residential building service for the filtration of water with chlorine or salt.
Quiet and reliable



Energy Saving

high performance
with low energy
consumption



Noiseless (60 DBA)

Silent running

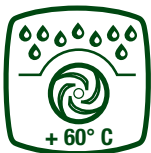

Reliability

Corrosion resistant
materials for a long life
even at extreme conditions

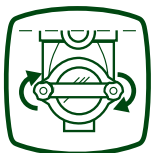

Semplicity

easy-to-open transparent
cover for quick cleaning of
the filter



MODEL	Q = 10 m
EUROSWIM 50	11 m ³ /h
EUROSWIM 75	14 m ³ /h
EUROSWIM 100	16 m ³ /h
EUROSWIM 150	23 m ³ /h
EUROSWIM 200	30 m ³ /h
EUROSWIM 300	38 m ³ /h

CERTIFICATIONS



FEATURES



DESIGN

This innovative solution combines aesthetics with sturdy materials highly resistant to corrosion and oxidation.



QUICK AND EASY CONNECTION

In & Out connection female, threaded 2".
Optional on request: special 3 pieces adjustment 50/63 mm.

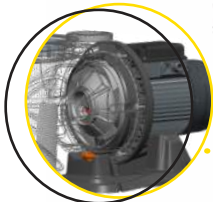

HYDRAULIC COMPONENTS

All components in contact with the liquid are made in polypropylene or noryl with glass fiber.
High efficiency Impeller with special design to cover and protect motor shaft against corrosion (motor is completely insulated)



LARGE PREFILTER

It has a large canister, up to 6 liters
Motor (suitable up to 60°) a transparent lid that can be removed without tools, and an internal filter easy to take out and clean.



ANTI-VIBRATION FEET

The support base guarantees stability and is equipped with rubber feet to reduce vibrations.



MOTOR

All metallic components are with surface treatment
Suitable for working in room with high temperature (up to 50°C)
With exhaust condensate holes
Capacitor is internal in the terminal board box
Water proof bearings



TERMINAL BOARD BOX

Easy and fast line connection,
It is totally closed against electrical motor to avoid any accidental solid bodies entry



SELECTION TABLE

RESIDENTIAL SWIMMING POOL

	DIMENSIONS OF POOL (m)	VOLUME OF WATER (m ³)	FLOW (m ³ / h)	MODEL
PRIVATE SWIMMING POOL	8 x 4	da 35 a 40	9	ESWIM 150 EUROSWIM 50 EUROSWIM 75
	da 8 x 4 a 10 x 5	da 50 a 70	12	ESWIM 150 EUROSWIM 75 EUROSWIM 100
	da 10 x 5 a 12 x 5	da 70 a 90	15	ESWIM 300 EUROSWIM 150
	da 11 x 6 a 12 x 6	da 90 a 110	18	ESWIM 300 EUROSWIM 150 EUROSWIM 200
PUBLIC SWIMMING POOL	8 x 4	da 35 a 40	14	ESWIM 150 EUROSWIM 100 EUROSWIM 150
	da 8 x 4 a 10 x 5	da 50 a 70	24	ESWIM 300 EUROSWIM 150 EUROSWIM 200
	da 10 x 5 a 12 x 5	da 70 a 90	30	ESWIM 300 EUROSWIM 200 EUROSWIM 300
	da 11 x 6 a 12 x 6	da 90 a 110	40	ESWIM 300 EUROSWIM 300

*Times for complete recirculation of water within 6 hours for private pool and 2/3 hours for public pool

ESWIM 150

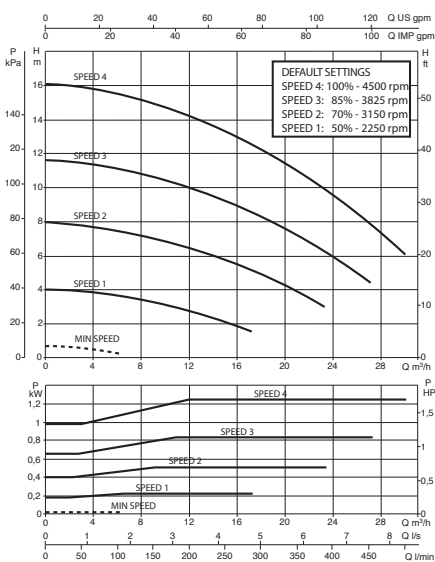

ESWIM 300

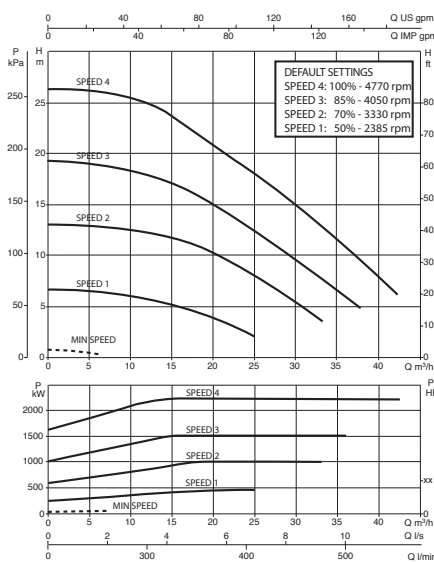

EUROSWIM

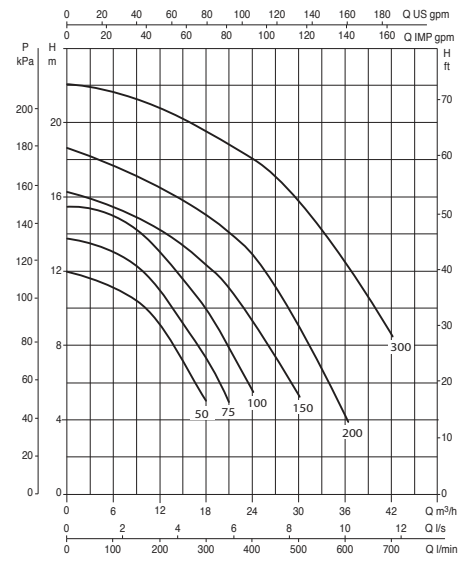



COMPARISON TABLE



ESWIM



Euroswim

FEATURES	ESWIM	Euroswim
HIGH EFFICIENCY HYDRAULICS		✓
HIGHLY RELIABLE AND DURABLE COMPONENTS	✓	✓
SMALL SIZE, FOR EASE OF INSTALLATION		✓
LCD DISPLAY	✓	✗
8 SPEEDS THAT CAN BE SET WITH TIMER	✓	✗
INTEGRATED DIAGNOSTICS FOR PROTECTION OF THE PUMP	✓	✗
OPERATION AT VARIABLE SPEED	✓	✗
OPERATION AT VARIABLE FLOW RATE	✓	✗
OPERATION AT CONSTANT FLOW RATE	✓	✗
HIGH EFFICIENCY “BRUSHLESS” MOTORS WITH PERMANENT MAGNETS	✓	✗
WATER COOLING WITHOUT NEED FOR FAN	✓	✗
BACKWASHING MODE	✓	✗

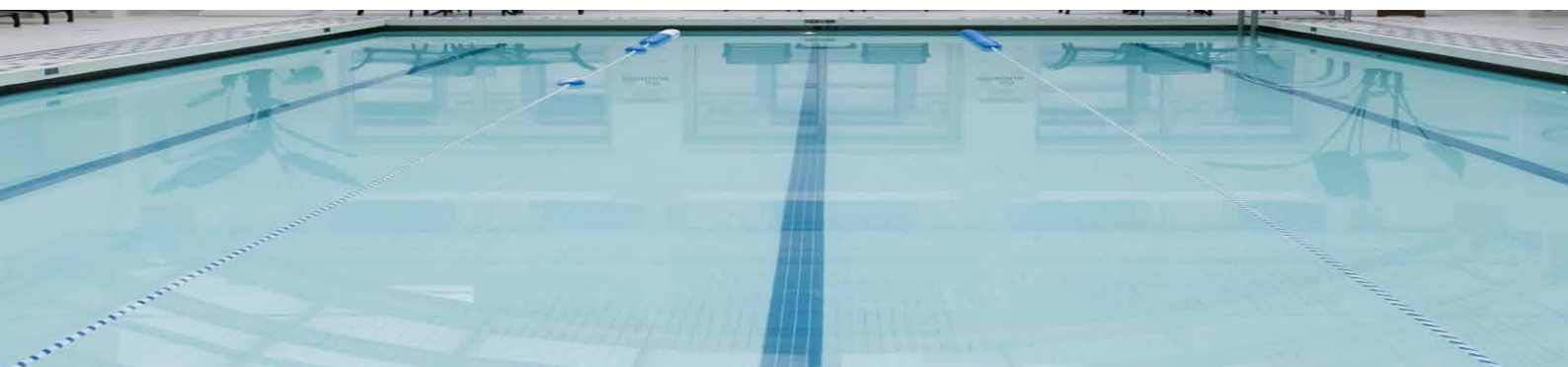

PUBLIC POOLS

EUROPRO HIGH FLOW

SWIMMING POOL LARGE FILTRATION

A silent and reliable pump for swimming pools in domestic and residential or civil and industrial sectors. 2 or 4 pole motor completely insulated from the water. Extremely quiet and highly reliable, developed for the circulation and filtration in large swimming pool filtration systems. Also suitable for particular applications that require handling of seawater thanks to the mechanical seal made of AISI 316.

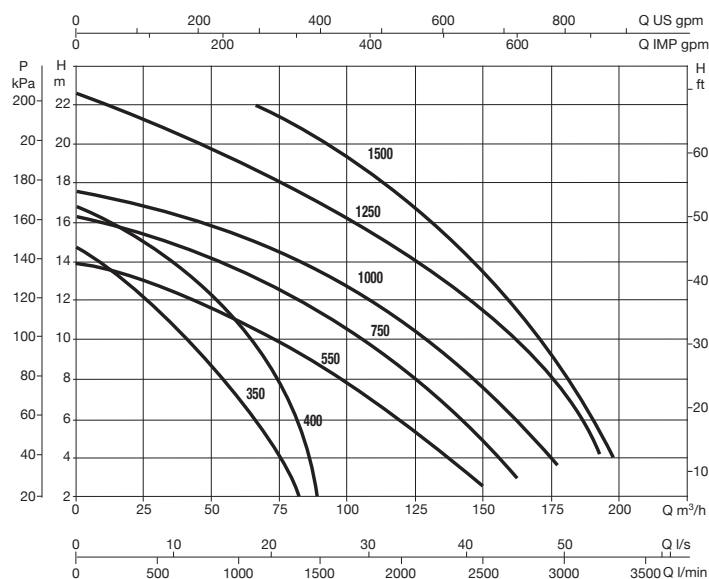

NKM-G / NKP G

SWIMMING POOL LARGE FILTRATION

The new range of prefilters gives the possibility of using the standardised monobloc centrifugal pumps of the NKM-G/NKP-G ranges, starting from DN 40 up to DN 150, for the circulation of water in large filtration systems



DRAINAGE PUMPS

EUROCOVER

SWIMMING POOL COVER PUMP

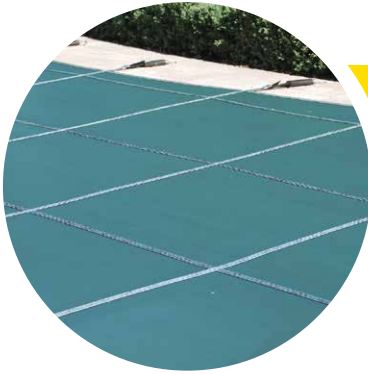

Submersible technopolymer pumps for draining swimming pool covers. The large support base guarantees stability, while the integrated float ensures automatic operation up to about 3 mm of residual water.



NOVA UP



VERTY NOVA



NOVA UP MAE

- Submersible pumps in technopolymer, ideal for draining areas subject to flooding or for temporary uses, such as emptying swimming pools, fountains, basins or small excavations. Available with or without float.

FEKA BVP



FEKA VS FEKA VSL



- Submersible pumps for draining and emptying muddy water even in the presence of solid particles with a diameter of up to 50 mm (depending on the model).

NOVA SALT W



- Submersible pumps for salt water management. Built with anti-corrosion and anti-oxidation material, they also work partially submerged.

SELF-PRIMING PUMPS

JETCOM SP - EUROCOM SP

SWIMMING POOL WATER SUPPLY

Single-impeller or multi-impeller pumps, suitable for cleaning swimming pools or for use with hydraulic cleaners even with salt water or chlorine, in residential building service.



MULTI 4 SW

- This self-priming and multi-impeller model is designed for swimming pools with salt water or chlorine, it can also be connected to hydraulic cleaners.



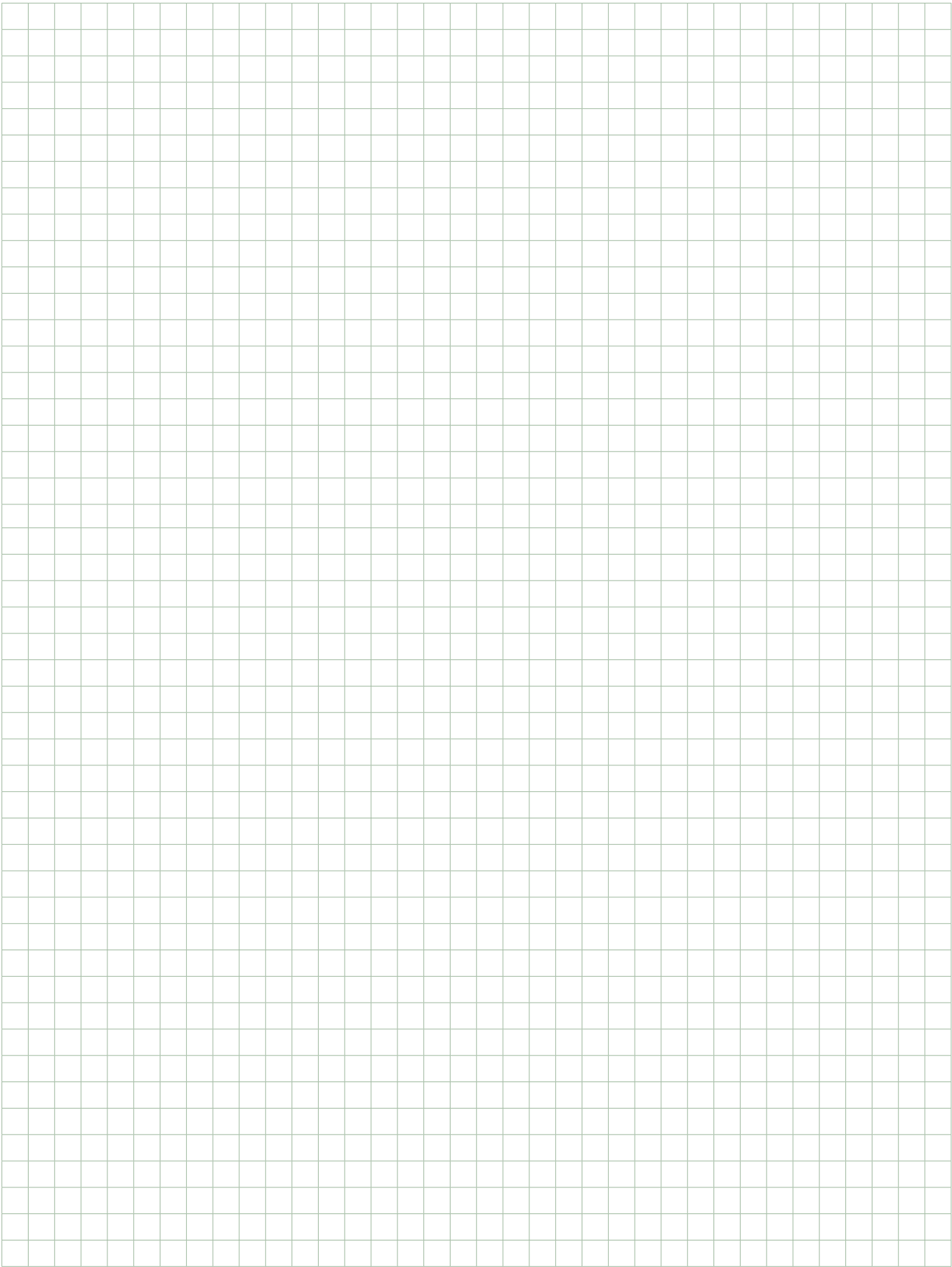



DAB PUMPS LTD.
6 Gilberd Court
Newcomen Way
Severalls Business Park
Colchester
Essex
CO4 9WN - UK
salesuk@dwtgroup.com
Tel. +44 0333 777 5010



DAB PUMPS BV
*Hofveld 6 C1
1702 Groot Bijgaarden - Belgium
info.belgium@dwtgroup.com
Tel. +32 2 4668353



DAB PUMPS B.V.
Albert Einsteinweg, 4
5151 DL Drunen - Nederland
info.netherlands@dwtgroup.com
Tel. +31 416 387280
Fax +31 416 387299



DAB PUMPS GMBH
Am Nordpark 3
D - 41069 Mönchengladbach - Germany
info.germany@dwtgroup.com
Tel. +49 2161 47388-0
Fax +49 2161 47388-36



DAB PUMPS IBERICA S.L.
Calle Verano 18-20-22
28850 - Torrejón de Ardoz - Madrid
Spain
Info.spain@dwtgroup.com
Tel. +34 91 6569545
Fax: + 34 91 6569676



DAB PUMPS HUNGARY KFT.
H-8800
Nagykanizsa, Buda Ernő u.5
Hungary
Tel. +36 93501700



DAB PUMPS POLAND Sp. z o.o.
Ul. Janka Muzykanta 60
02-188 Warszawa - Poland
polska@dabpumps.com.pl



OOO DAB PUMPS
Novgorodskaya str. 1, block G
office 308, 127247, Moscow - Russia
info.russia@dwtgroup.com
Tel. +7 495 122 0035
Fax +7 495 122 0036



DAB PUMPS INC.
3226 Benchmark Drive
Ladson, SC 29456 - USA
info.usa@dwtgroup.com
Tel. 1- 843-797-5002
Fax 1-843-797-3366



DAB PUMPS SOUTH AFRICA (PTY) LTD
Twenty One industrial Estate,
16 Purlin Street, Unit B, Warehouse 4
Ollifantsfontein -1666 - South Africa
info.sa@dwtgroup.com
Tel. +27 12 361 3997



DAB PUMPS (QINGDAO) CO. LTD.
No.40 Kaituo Road, Qingdao Economic & Technological
Development Zone
Qingdao City, Shandong Province - China
PC: 266500
sales.cn@dwtgroup.com
Tel. +86 400 186 8280
Fax +86 53286812210



DAB PUMPS DE MÉXICO, S.A. DE C.V.
Av Amsterdam 101 Local 4
Col. Hipódromo Condesa,
Del. Cuauhtémoc CP 06170
Ciudad de México
Tel. +52 55 6719 0493



DAB PUMPS OCEANIA PTY LTD
426 South Gippsland Hwy,
Dandenong South VIC 3175 – Australia
info.oceania@dwtgroup.com
Tel. +61 1300 373 677



PT DAB PUMPS INDONESIA
Satrio Tower lantai 26
unit C-D, Jl. Prof. Dr. Satrio Kav. C4,
Kel. Kuningan Timur, Kec. Setiabudi, Kota Adm.
Jakarta Selatan, Prov. DKI Jakarta. - Indonesia
Tel. +62 2129222850